

July 2014

Genuine GM and Quality  
Reproduction Parts for

# 1962-1974

## Chevy II / Nova



GM Restoration  
Parts

ORANGE CA.

[www.TruckandCarShop.com](http://www.TruckandCarShop.com)

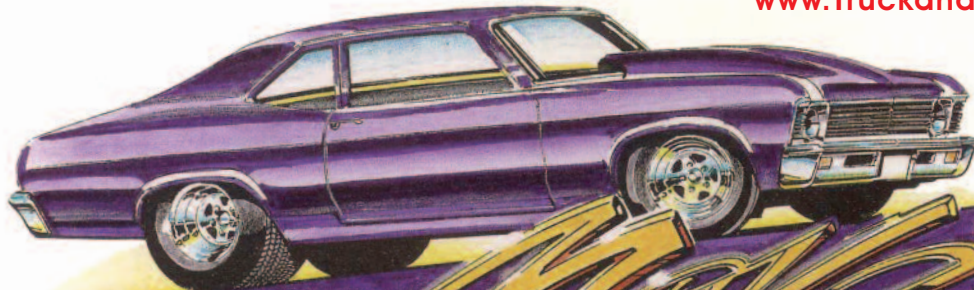

# CHEVROLET

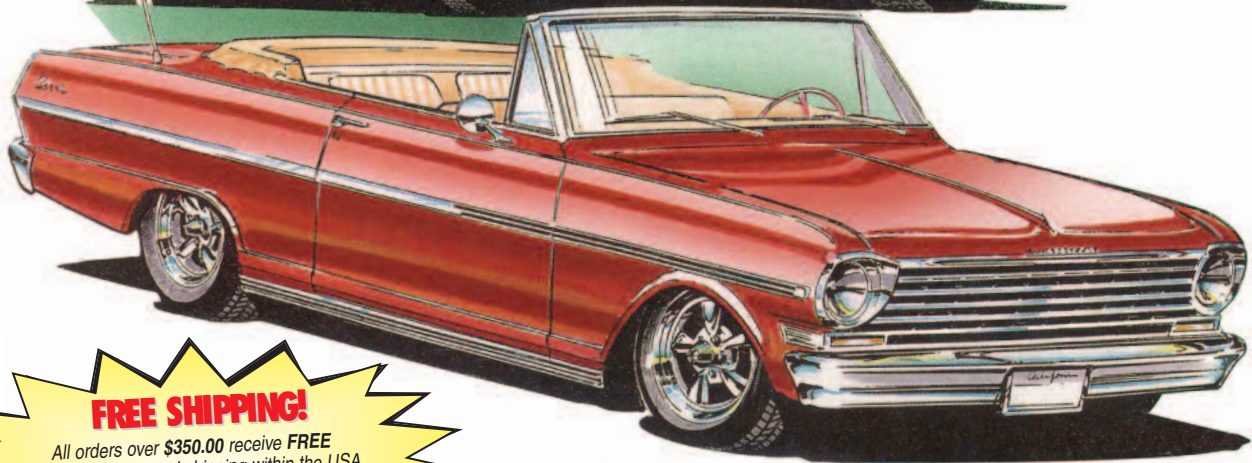
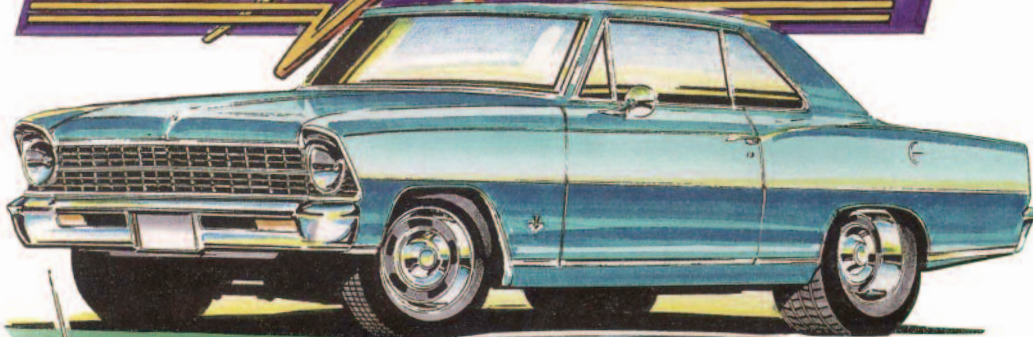

**FREE SHIPPING!**

All orders over \$350.00 receive **FREE**  
standard UPS ground shipping within the USA.  
(excludes Alaska and Hawaii).

Truck freight items, oversize, overweight,  
additional handling, expedited and overnite shipments  
do not apply to free shipping incentive.

**Car Shop Showroom Hours:**

**TUESDAY-FRIDAY: 8:30AM to 4:30PM & SATURDAY: 8:30AM to 3:30PM**

**New phone order desk hours:**

**MONDAY - FRIDAY: 8:30AM to 4:30PM**

**1-800-235-2470**

739 NORTH BATAVIA ORANGE, CALIFORNIA 92868



**ORANGE CA.**

# QUALITY RESTORATION PARTS AND ACCESSORIES

- GRILLS • BEZELS • STEERING WHEELS • INTERIOR ITEMS • SUSPENSION • COIL SPRINGS •
- LENSES • WINDOW SEALS • WEATHERSTRIPS • HUB CAPS • BRAKE HARDWARE •
- EMBLEMS • CARPETING • SEAT UPHOLSTERY • ELECTRICAL BODY PARTS •
- RADIOS • MOLDINGS • GLASS • BED RAILS • FLOOR PANS • PEDAL PADS •
- MIRRORS • GLOVE BOXES • LOCK SETS • MANUALS •
- DISC BRAKE KITS • AND MUCH MORE •



**Quality Restoration Parts for:**



- |                  |                  |                  |                |                 |                  |                  |                  |                |                |                |
|------------------|------------------|------------------|----------------|-----------------|------------------|------------------|------------------|----------------|----------------|----------------|
| <b>1941-57</b>   | <b>1958-72</b>   | <b>1964-87</b>   | <b>1967-81</b> | <b>1962-74</b>  | <b>1947-59</b>   | <b>1960-72</b>   | <b>1973-91</b>   | <b>1964-73</b> | <b>1966-86</b> | <b>1948-86</b> |
| <b>CHEVROLET</b> | <b>CHEVROLET</b> | <b>CHEVELLE</b>  | <b>CAMARO</b>  | <b>CHEVY II</b> | <b>CHEVROLET</b> | <b>CHEVROLET</b> | <b>CHEVROLET</b> | <b>FORD</b>    | <b>FORD</b>    | <b>FORD</b>    |
| <b>PASSENGER</b> | <b>PASSENGER</b> | <b>EL CAMINO</b> |                | <b>NOVA</b>     | <b>GMC</b>       | <b>GMC</b>       | <b>GMC</b>       | <b>MUSTANG</b> | <b>BRONCO</b>  | <b>TRUCK</b>   |
| <b>CAR</b>       | <b>CAR</b>       |                  |                |                 | <b>TRUCK</b>     | <b>TRUCK</b>     | <b>TRUCK</b>     |                |                |                |



**Order Your FREE Catalog Today!**  
[www.TruckandCarShop.com](http://www.TruckandCarShop.com)

**TRUCK & CAR SHOP Showroom is open:**  
**TUESDAY-FRIDAY 8:30 to 4:30**  
**SATURDAY 8:30 to 3:30**  
**SUNDAY & MONDAY Closed**

**For more information:**  
**TEL: 1-714-771-6432**  
**FAX: 1-714-771-0407**

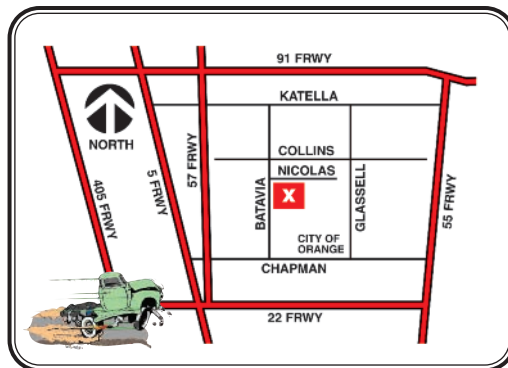

**Truck and Car Shop Inc. 739 North Batavia Orange, CA 92868**  
**Fax Order 1-714-771-0407 • Toll Free 1-800-235-2470 • www.TruckandCarShop.com**



# ORDERING & MERCHANDISE RETURN POLICIES

## PHONE ORDERS

When you call please have the part number and a brief description of the items you want ready.

## MAIL ORDER

Be sure to include your phone number with your order, both home and work.

## BANKCARDS

We accept Mastercard or Visa. A **\$25.00** minimum purchase on all charge card orders is required. Sorry, no volume discounts on charge cards.

## CHECKS: \$15.00 CHARGE FOR RETURNED CHECKS

Personal checks are accepted by mail order only. A **\$25.00** minimum purchase is required. Orders will be held until your check clears your bank (approximately 3 weeks).

## FOREIGN ORDERS

All foreign orders must be prepaid in U.S. funds only. All foreign sales are final.

## UPS (United Parcel Service)

We ship almost everything by UPS—it is normally the quickest and least expensive method of shipping. UPS will not ship to a P.O. Box.

## TRUCK SHIPMENTS

The larger and heavier items cannot be shipped by UPS and must be sent via motor freight. All truck shipments must be prepaid. All sales involving truck shipments are final.

## DAMAGE CLAIMS

Make sure you inspect all packages in the presence of the carrier. If you receive a package that has been damaged or opened, make a claim with the driver at that time. All claims of loss, damage or destruction must be made by you to the carrier.

## REFUSED SHIPMENTS

Permission must be obtained prior to returning merchandise. All authorized returns must be shipped prepaid. If you refuse your shipment for any reason, we pay shipping both ways to get the merchandise back. All refused shipments are subject to a **20% restocking fee** plus freight charges both ways, and will be billed accordingly. Unauthorized returns will be refused. No exchanges and no refunds will be made after 30 days of purchase or without sales receipt. No electrical parts, literature or truck freight items are returnable.

## CREDIT CARDS

*Truck Shop/Car Shop* accepts Visa and Mastercard, (bank issued only), no gift cards or rebate cards. Card must have users name imprinted. Valid drivers license with photo ID & 2nd form of ID required. Name on Drivers license must match name on credit card, no exceptions!

When placing your order, be sure to indicate the card holders name, address, phone number, credit card number, expiration date and billing address (we only ship to the billing address). A security code may be required for credit card purchases.

Minimum order is \$25.00.

## IN THE EVENT OF DAMAGE TO ANY SHIPMENT

### PLEASE FOLLOW THESE INSTRUCTIONS

1. Damaged merchandise must be kept in the original (outside) carton for UPS inspection. PLEASE DO NOT RETURN DAMAGED PARTS TO CAR SHOP.
2. There is a UPS depot near you, contact UPS for inspection. If not, notify us immediately, of all damage. We will contact UPS and let you know what to do with the damaged merchandise.
3. Before accepting the shipment, count the cartons to be sure you are receiving the quantity listed on the bill of lading. If there is a shortage, note the shortage on the freight bill.
4. Examine the shipment immediately. In the event of damage, NOTIFY DELIVERING CARRIER. He will furnish a "Concealed Damage Report" form which must be used as part of your claim. The other necessary papers are a copy of the paid freight bill, copy of the invoice, and the bill of lading.
5. File your claim for the full value. of the damaged items as listed on the invoice.

## TRUCKER IS RESPONSIBLE FOR BREAKAGE IN TRANSIT.

Our Parcel Post shipments are covered by Post Office Insurance.

DO NOT RETURN DAMAGED PARTS TO US. Should any of the contents be damaged, you must submit the ENTIRE container and damaged merchandise to your local Postmaster, who will then institute a claim.

## SPECIAL ORDERS

All special order products must be pre-paid in full and are non-returnable.

Absolutely no returns on any/all special orders of any nature.

## BACK ORDERS

Any items not in stock and not expected for 3–10 working days will placed on back order and shipped as soon as possible.

## MERCHANDISE RETURNS • EXCHANGES • REFUNDS •

All returns, exchanges or refunds are based on **date of purchase**, not the date of installation.

All shipments must be inspected upon receipt. Any issues must be reported to *Truck Shop/Car Shop* within 3 working days. At that time *Truck Shop/Car Shop* will advise and direct proper handling and/or return.

*Truck Shop/Car Shop* is not responsible if no notification is given after 3 working days of receipt of goods.

Should you need to return a part for refund, exchange or credit, please contact our customer service department for a return authorization number and instructions.

*Truck Shop/Car Shop* will not accept returned goods without prior authorization. Customer will pay freight on all return orders.

All returned merchandise must be accompanied by a letter of explanation giving **DATE** merchandise was ordered, and **NAME** merchandise was ordered under. Return items must be sent PREPAID. Any return items are subject to a 15% restocking fee. Unauthorized returns will be refused.

No exchanges and no refunds will be made after 30 days of purchase or without sales receipt.

Absolutely no returns without a legible itemized written or printed receipt. Credit card statements do not qualify as proof of purchase.

**Special orders, literature, printed materials, stencil/stripe kits, electrical parts, wiring harnesses, tools or truck freight items are non-returnable.**

Items that are defective and under warranty will be eligible for exchange only.

## INSTALLED ITEMS

If any product is modified, altered, painted, installed or disassembled in any way, the item is non-returnable.

Any item which has been altered, painted, installed or deemed non-resalable by *Truck Shop/Car Shop* will be returned to the customer at the customers expense.

If a part purchased from *Truck Shop/Car Shop* is installed and deemed defective, *Truck Shop/Car Shop* will exchange defective part(s). However *Truck Shop/Car Shop* will hold no liability, responsibility, written, or implied otherwise for any cost of repairs, reimbursement of time, labor and/or any expense regardless of circumstances which are beyond our control.

*Truck Shop/Car Shop* is not responsible or liable for labor fees associated with the installation, removal, modification, painting or repair of any product purchased regardless of the circumstances.

*Truck Shop/Car Shop* is not responsible for any damage or discoloration incurred in relation to chemical products being used including cleaners, waxes, polishes, paints, etc.

Having no control over any/all installation(s) *Truck Shop/Car Shop* assumes no liability written or implied.

For liability purposes *Truck Shop/Car Shop* cannot provide technical information on how parts are installed. *Truck Shop/Car Shop* is not certified to offer this information and cannot be held responsible for any/all installations. *Truck Shop/Car Shop* always recommends professional installation on all products.

**Gift certificates** have no cash value and must be redeemed for merchandise only.

**Note:** When using this catalog "Left" or "LH" is the driver's side and "Right" or "RH" is the passenger side.

"GM", "Chevrolet" and "Nova" are registered trademarks of General Motors Corporation and are used in this catalog for reference and identification purposes only.

**• Prices are subject to change without notice! •**

## Car Shop Sheet Metal

Most panels are E-D-Primer coated or Weld-thru Primer coated and are carefully packaged to protect against damage that may occur during transit. Most parts are individually boxed for damage free shipping. However, after overseas transport & cross country delivery to you, it is likely there could be a small ding or minor scratch. These minor blemishes cannot be helped and are considered normal due to the nature of the product.

**Test fit all panels prior to paint and installation.**

Any physical damage in transit must be reported to delivering carrier at time of delivery.

# P A R T S   I N D E X

## A

|                                  |         |                                  |         |                                 |         |                                |         |
|----------------------------------|---------|----------------------------------|---------|---------------------------------|---------|--------------------------------|---------|
| A-Arm                            | 111     | Air Cleaner Spacer               | 172     | Bezel, Park Light Lens          | 60      | Brake Hose to Caliper Bolt Kit | 121     |
| A-Arm Bolt Kit                   | 112     | Air Cleaner Stud                 | 172     | Bezel, Side Marker              | 59      | Brake Hose Copper Washers      | 121     |
| A-Arm Bumper                     | 112     | Air Cleaner to Carb Gasket       | 172     | Billet Steering Wheels          | 103     | Brake Hose Retainer            | 121     |
| A-Arm Bushing Retainer Kit       | 112     | Air Cleaner Wing Nut             | 172     | Bleeder Screw                   | 122     | Brake Hose Retainer Clips      | 122     |
| A-Arm Shaft Kit                  | 110     | Air Duct Deflector Vent          | 45      | Bleeder Screw Dust Caps         | 122     | Brake Kits                     | 127-128 |
| A-Arm Splash Flaps               | 56      | Air Duct Hose                    | 44      | Blower Motor                    | 156     | Brake Light Switch             | 95      |
| A/C Box                          | 153     | Air Duct Seal Kit                | 44      | Blower Motor Relay              | 156     | Brake Light Switch Retainer    | 95      |
| A/C Brackets                     | 154-155 | Air Outlet Vents                 | 44-45   | Blower Motor Resistor           | 156     | Brake Lines                    | 131-132 |
| A/C Compressor                   | 153     | Air Vent Cables                  | 44      | Blue Dots, Tail Light           | 61      | Brake Line Armor Shield        | 122     |
| A/C Compressor Decal             | 199     | Alignment Shims                  | 112     | Bluetooth Interface Connector   | 78      | Brake Line Clips               | 132     |
| A/C Condenser                    | 153     | Alternator                       | 166     | Body Fastener Kits              | 134     | Brake Line Junction Block      | 121     |
| A/C Condenser Brackets           | 154-155 | Alternator Brackets              | 166-168 | Body Manual                     | 204     | Brake Line Cylinder            | 122-123 |
| A/C Condenser Fitting            | 154     | Alternator Bracket Spacer Sleeve | 167     | Body Mount Bolt Kit             | 112     | Brake Pads/Shoes               | 124     |
| A/C Condenser Muffler            | 154     | Alternator Conversion Wiring     | 83,166  | Body Mount Bushings             | 112     | Brake Pedal                    | 148     |
| A/C Control Cables               | 44      | Alternator Decal                 | 201     | Body Panel, Rear                | 139     | Brake Pedal Bumper             | 149     |
| A/C Control Fan Switch           | 43      | Alternator Fan & Pulley          | 166     | Body Sealer                     | 56      | Brake Pedal Bushing            | 149     |
| A/C Control Panel                | 43      | Alternator Mounting Bolts        | 168     | Body Shims                      | 133     | Brake Pedal Pads               | 147-148 |
| A/C Decals                       | 199     | Alternator Pigtail               | 168     | Body Side Moldings              | 71,72   | Brake Pedal Retaining Pin      | 149     |
| A/C Delete Firewall Cover        | 153     | Alternator Pulley                | 166     | Bolts, A-Arm                    | 112     | Brake Pedal Support            | 149     |
| A/C Drier                        | 156     | Alternator Spacer and Brace      | 168     | Bolts, Battery Tray             | 90      | Brake Release Handle           | 130     |
| A/C Duct                         | 45      | Alternator Wire Rubber Boot      | 168     | Bolts, Body Mount               | 112     | Brake Rotor                    | 125     |
| A/C Evaporator Case / Box        | 153     | AM/FM Instruction Card           | 200     | Bolts, Door Hinge               | 48      | Brake Shoe Anchor Pin          | 120     |
| A/C Evaporator Case Drain Hose   | 153     | Antenna Kits                     | 82-83   | Bolts, Front End                | 133     | Brake Shoes                    | 124     |
| A/C Evaporator Core              | 153     | Antenna Parts                    | 82      | Bolts, Hex Head                 | 133     | Brake Shoes                    | 124     |
| A/C Expansion Valve              | 153     | Anti-Diesel Solenoid Wire        | 83      | Bolts, Seat belt                | 20      | Brake Spring & Hold Down Kit   | 120     |
| A/C Firewall Box Decal           | 199     | Arm Rest Ash Tray                | 17      | Bolts, Shocks                   | 113     | Brake Shoe Levers              | 121     |
| A/C Harness                      | 83      | Arm Rest Base                    | 18-19   | Bolts, Thermostat Housing       | 182     | Brass Unions                   | 131     |
| A/C Hose & Muffler Assembly      | 154     | Arm Rest Covers, Rear            | 17      | Bolts, Valve Cover              | 185     | Breather Cap                   | 186     |
| A/C Hose to Fender Grommet       | 154     | Arm Rest Pads                    | 19-20   | Books                           | 202-205 | Breather Cap Decal             | 198     |
| A/C Lens                         | 44      | Arm Rest Screws                  | 19      | Boot, Clutch Rod                | 150     | Bucket Seats                   | 8       |
| A/C O-ring Seal Kit              | 153     | Ashtrays                         | 17,39   | Bracket, A/C Compressor         | 154-155 | Bucket Seat Backs              | 8-9     |
| A/C Outlet Bezel Fastener Kit    | 45      | Ashtray Bumpers                  | 39      | Bracket, Back-Up Light Switch   | 32      | Bucket Seat Chrome Trim        | 10      |
| A/C Power Feed Wire              | 83      | Assembly Manual                  | 204     | Bracket, Bumper                 | 75      | Bucket Seat Frames             | 8       |
| A/C Switch                       | 43      | Axle Bumper                      | 116     | Bracket, Bumper Guards          | 75      | Bucket Seat Mounting Brackets  | 9       |
| A/C Thermal Limiter              | 156     | Axle Pinion Seal                 | 116     | Bracket, Clutch Bellcrank Ball  | 150     | Bucket Seat Springs            | 8       |
| A/C Vacuum Reservoir Tank        | 153     | <b>B</b>                         |         | Bracket, Grill                  | 69      | Bulb, Dome Light               | 28      |
| A/C Vacuum Switch Rubber Cap     | 43      | Back-Up Lamp Switch              | 31      | Bracket, License Plate          | 76      | Bulb, Head Light               | 67      |
| A/C Vents                        | 44-45   | Back-Up Lamp Switch Bracket      | 32      | Bracket, Mirror                 | 49-50   | Bulbs                          | 87      |
| A/C Window Decal                 | 199     | Back-Up Lamp Switch Mounting Kit | 32      | Bracket, Power Steering         | 104     | Bumpers                        | 74-75   |
| Accelerator Cable                | 147     | Back-Up Lamp Switch Rod Clips    | 32      | Bracket, Proportioning Valve    | 129     | Bumper Bolts                   | 76      |
| Accelerator Cable Bracket        | 147     | Backup Light Lens                | 62      | Bracket, Washer Jar             | 159     | Bumper Brackets                | 75      |
| Accelerator Pedal & Trim         | 145     | Ball Joint                       | 109     | Brake Adjuster Hole Cover       | 120     | Bumper Bracket Hardware        | 75-76   |
| Accelerator Rod                  | 145     | Ball Joint Boot                  | 109     | Brake Adjuster Repair Kits      | 120     | Bumper Filler Panel            | 137     |
| Accelerator Rod Grommet & Sleeve | 146     | Ball Joint Rivet Bolt Set        | 109     | Brake Booster                   | 126,128 | Bumper Guards                  | 75      |
| Accelerator Rod Swivel Kit       | 146     | Ball Stud, Clutch                | 149,150 | Brake Booster Check Valve       | 126     | Bumper Guard Hardware          | 75      |
| Accelerator Return Spring Kit    | 147     | Barrel Nuts                      | 74      | Brake Booster Hose Kit          | 126     | Bumper Guard Rubber Cushions   | 75      |
| Accessory Brochure               | 205     | Battery Cables                   | 90      | Brake Booster Hose Bracket      | 126     | Bumper Jack                    | 77      |
| Adhesive Spray                   | 22,52   | Battery Cable Clip               | 90      | Brake Cables & Hardware         | 130-131 | Bumper Mounting Hardware Kits  | 76      |
| Adhesive, Weatherstrip           | 53      | Battery Cable Clamp              | 90      | Brake Caliper                   | 124     | Bumper, Seat Back, Rubber      | 10      |
| Adjusting Sleeve, Tie Rod        | 108     | Battery Tray                     | 90      | Brake Caliper Hardware Kit      | 124     | Bushing, Body Mount            | 112     |
| Air Cleaners                     | 170-171 | Battery Tray Bolts               | 90      | Brake Caliper Mounting Bolt     | 124     | Bushing, Control Arm           | 110     |
| Air Cleaner Decal                | 197     | Battery Tray Clamp/Retainer      | 90      | Brake Caliper Mounting Brackets | 124     | Bushing, Leaf Springs          | 115     |
| Air Cleaner Element              | 172     | Battery Warning Decal            | 198     | Brake Drums                     | 125     | Bushing, Sway Bar              | 114     |
| Air Cleaner Flame Arrestor       | 172     | Bellhousing                      | 150,194 | Brake Drum Assemblies           | 125     | Bypass Hose Clamps             | 182     |
| Air Cleaner Lid                  | 172     | Bellhousing Bolt Kit             | 195     | Brake Drum Backing Plates       | 124     | Bypass Hose Fittings           | 182     |
| Air Cleaner Lid Seal             | 172     | Bellcrank Ball Stud              | 149-150 | Brake Hardware Kit              | 121     |                                |         |
| Air Cleaner Service Decal        | 200     | Bellcrank Ball Stud Felt Seal    | 149     | Brake Hold Off Valve            | 130     |                                |         |
| Air Cleaner Service Instructions | 200     | Below Rear Window Panel          | 140     | Brake Hose                      | 121     |                                |         |
|                                  |         | Bezel, Headlight                 | 68      | Brake Hose Bracket              | 121     |                                |         |

# P A R T S I N D E X

|  |                        |  |                                  |  |                                     |   |         |
|--|------------------------|--|----------------------------------|--|-------------------------------------|---|---------|
| <b>C</b>                                   | Clutch Pedal . . . . . | 149  | Convertible Top Cables . . . . . | 51   | Differential Cover Gasket . . . . . | 116   |         |
| C-5 Disc Brake Kit . . . . .               | 127                    | Clutch Pedal Pads & Trim Plates . . . . .      | 148                              | Convertible Top Cylinders . . . . .          | 51                                  | Differential Filler Plug . . . . .          | 117     |
| C-5 Disc Brake Spindles . . . . .          | 125                    | Clutch Pedal Retainer . . . . .                | 149                              | Convertible Top Frame Bumpers . . . . .      | 54                                  | Differential Lubricant Tag . . . . .        | 117     |
| Cable Ball Studs . . . . .                 | 146                    | Clutch Pressure Plate Bolt Kit . . . . .       | 195                              | Convertible Top Handles . . . . .            | 51                                  | Differential Vent . . . . .                 | 116     |
| Calipers, Brake . . . . .                  | 124                    | Clutch Push Rod Clip . . . . .                 | 150                              | Convertible Top Hook . . . . .               | 51                                  | Dimmer Switch . . . . .                     | 94      |
| Caliper Hardware . . . . .                 | 124                    | Clutch Release Fork Stud . . . . .             | 150                              | Convertible Top Hose Kit . . . . .           | 51                                  | Dimmer Switch Carpet Grommet . . . . .      | 94      |
| Caliper Mounting Brackets . . . . .        | 124                    | Clutch Return Spring . . . . .                 | 149                              | Convertible Top Latch Bushings . . . . .     | 51                                  | Dip Sticks . . . . .                        | 190,194 |
| Cancelling Cam, Turn Signal . . . . .      | 100                    | Clutch Return Spring Extension . . . . .       | 149                              | Convertible Top Latch Handles . . . . .      | 51                                  | Directional Signal Flasher . . . . .        | 96      |
| Car Covers . . . . .                       | 205                    | Clutch Rod Boot . . . . .                      | 150                              | Convertible Top Manual . . . . .             | 205                                 | Disc Brake Backing Plates . . . . .         | 124     |
| Car Duster . . . . .                       | 206                    | Clutch Rod Hole Cover Plate . . . . .          | 150                              | Convertible Top Motor . . . . .              | 51                                  | Disc Brake Conversion Lines . . . . .       | 132     |
| Carburetors . . . . .                      | 173-174                | Coat Hooks . . . . .                           | 27                               | Convertible Top Motor Grommets . . . . .     | 51                                  | Disc Brake Kits . . . . .                   | 127-128 |
| Carburetor Adapter Kit . . . . .           | 173                    | Coil . . . . .                                 | 92                               | Convertible Top Pad Kit . . . . .            | 50                                  | Disc Brake Proportioning Valves . . . . .   | 129-130 |
| Carburetor Calibration Kit . . . . .       | 174                    | Coil Bracket & Bolts . . . . .                 | 92                               | Convertible Top Track Strip . . . . .        | 50                                  | Disc Brake Rotor . . . . .                  | 125     |
| Carburetor Fuel Inlet Kit . . . . .        | 174                    | Coil Springs . . . . .                         | 113                              | Convertible Top Weatherstrip . . . . .       | 54                                  | Distributor . . . . .                       | 90-91   |
| Carburetor Gas Line . . . . .              | 174,177                | Coil Spring Insulators . . . . .               | 113                              | Convertible Well Liner . . . . .             | 51                                  | Distributor Caps . . . . .                  | 91      |
| Carburetor Mounting Kit . . . . .          | 173                    | Coil Springs Perch . . . . .                   | 114                              | Convertible Well Molding Clip . . . . .      | 51                                  | Distributor Condenser . . . . .             | 92      |
| Carpet Firewall Guard . . . . .            | 24                     | Coil Springs Perch Hardware Kit . . . . .      | 114                              | Cooling System Decals . . . . .              | 199                                 | Distributor Contact Points . . . . .        | 91      |
| Carpet Kits . . . . .                      | 22                     | Coil Springs Seat . . . . .                    | 114                              | Courtesy Light Brackets . . . . .            | 28                                  | Distributor Gasket . . . . .                | 91      |
| Castle Nut Kit . . . . .                   | 109                    | Column Shift Conversion Linkage . . . . .      | 30                               | Cowl Induction Emblems . . . . .             | 64                                  | Distributor Hold Down Kit . . . . .         | 91      |
| Caution Fan Decal . . . . .                | 199                    | Column Shift Indicator Lens . . . . .          | 30                               | Cowl Induction Hood . . . . .                | 136                                 | Distributor Points Conversion Kit . . . . . | 92      |
| CD Changer . . . . .                       | 79                     | Column Shift Lever Knob . . . . .              | 30                               | Cowl Panel . . . . .                         | 137                                 | Distributor Rotor . . . . .                 | 91      |
| Center Dash Panel . . . . .                | 38                     | Column Shift Rod Swivel . . . . .              | 30                               | Cowl Panel Seal Kit . . . . .                | 54                                  | Distributor Vacuum Advance Unit . . . . .   | 93      |
| Center Cap, Wheel . . . . .                | 118-119                | Column Shift Swivel & Rod Assembly . . . . .   | 29                               | Cowl Panel Screw Kit . . . . .               | 136                                 | Distributor Vacuum Line . . . . .           | 193     |
| Center Cap Inserts, Wheel . . . . .        | 118-119                | Column to Transmission Shift Rod . . . . .     | 30                               | Cowl Vent Panel . . . . .                    | 136                                 | Dome Light Assembly . . . . .               | 28      |
| Center Console Shift Plate . . . . .       | 32                     | Condenser, Distributor . . . . .               | 92                               | Crank Case Breather Decal . . . . .          | 198                                 | Dome Light Base . . . . .                   | 28      |
| Centerlink, Steering . . . . .             | 108                    | Console . . . . .                              | 35                               | Crank Case Vent Tube . . . . .               | 185                                 | Dome Light Bulb . . . . .                   | 28      |
| Chassis Fastener Kits . . . . .            | 134                    | Console Emblem . . . . .                       | 35                               | Crank Case Vent Tube Mount Kit . . . . .     | 185                                 | Dome Light Harness . . . . .                | 28      |
| Choke Cover . . . . .                      | 173                    | Console Forward Panel . . . . .                | 35                               | Crank Shaft Pulley . . . . .                 | 191-192                             | Dome Light Lens . . . . .                   | 28      |
| Choke Kits . . . . .                       | 173                    | Console Gauges . . . . .                       | 36                               | Crank Shaft Pulley Bolt Kit . . . . .        | 192                                 | Dome Light Switch . . . . .                 | 28      |
| Choke Tube . . . . .                       | 172                    | Console Gauge Bezel . . . . .                  | 37                               | Cruise Control Decal . . . . .               | 201                                 | Door Alignment Wedges . . . . .             | 51      |
| Choke Tube Insulation . . . . .            | 172                    | Console Gauge Connector Kit . . . . .          | 36                               | Cut Nuts . . . . .                           | 74                                  | Door Bumpers . . . . .                      | 55      |
| Cigarette Lighter . . . . .                | 40                     | Console Gauge Face Rivets . . . . .            | 36                               | Cylinder Head Bolt Kit . . . . .             | 179                                 | Door Frame Molding Kit . . . . .            | 72      |
| Cigarette Lighter Housing . . . . .        | 40                     | Console Gauge Hardware Kit . . . . .           | 36                               | Cylinder Head Gasket . . . . .               | 185                                 | Door Glass Assembly . . . . .               | 57      |
| Circuit Board . . . . .                    | 42                     | Console Gauge Housing & Base . . . . .         | 36                               |  |                                     | Door Glass Setting Channel . . . . .        | 47      |
| Clips, Universal . . . . .                 | 74                     | Console Gauge Lens . . . . .                   | 37                               |  |                                     | Door Glass Vertical Run Channel . . . . .   | 53      |
| Clip, Battery Cable . . . . .              | 90                     | Console Gauge Light Bulbs . . . . .            | 37                               | <b>D</b>                                     |                                     | Door Glass Window Frame . . . . .           | 73      |
| Clip, Brake Line . . . . .                 | 121,132                | Console Gauge Mounting Brackets . . . . .      | 37                               | Dash Bezels . . . . .                        | 40                                  | Door Handle, Exterior . . . . .             | 47      |
| Clip, Clutch Rod . . . . .                 | 150                    | Console Gauge Mounting Plates . . . . .        | 37                               | Dash Bulb Socket . . . . .                   | 87                                  | Door Handle, Interior . . . . .             | 45      |
| Clip, Convertible Well Molding . . . . .   | 51                     | Console Gauge Set . . . . .                    | 36                               | Dash Duster . . . . .                        | 206                                 | Door Handle Bezel . . . . .                 | 45      |
| Clip, Door Panel Installation . . . . .    | 17                     | Console Harness . . . . .                      | 83                               | Dash Emblem . . . . .                        | 39                                  | Door Handle & Lock Gasket Set . . . . .     | 47      |
| Clip, Rocker Panel Molding . . . . .       | 71                     | Console Kits . . . . .                         | 35                               | Dash Extension Harness . . . . .             | 83                                  | Door Handle Mechanism . . . . .             | 45      |
| Clip, Vacuum Advance Line . . . . .        | 93                     | Console Lens . . . . .                         | 32                               | Dash Gauge Lens . . . . .                    | 39                                  | Door Handle Mechanism . . . . .             | 45      |
| Clip, Window Molding . . . . .             | 73                     | Console Mounting Bracket . . . . .             | 35                               | Dash Grab Handle . . . . .                   | 39                                  | Door Handle Push Buttons . . . . .          | 47      |
| Clock, Dash . . . . .                      | 42                     | Console Parts . . . . .                        | 35-37                            | Dash Harness . . . . .                       | 84                                  | Door Handle Rod Hardware . . . . .          | 45      |
| Clock Delete Plate . . . . .               | 43                     | Console Screw Kit . . . . .                    | 37                               | Dash Instrument Bezel . . . . .              | 38                                  | Door Handle Screw Kit . . . . .             | 47      |
| Clock Harness . . . . .                    | 83                     | Console Shift Plate . . . . .                  | 32                               | Dash Instrument Bezel Fastener Kit . . . . . | 39                                  | Door Hinge . . . . .                        | 48      |
| Clock Hole Plug . . . . .                  | 43                     | Console Top Plate . . . . .                    | 35                               | Dash Knob Bezels . . . . .                   | 40                                  | Door Hinge Bolts . . . . .                  | 48      |
| Clock Knob Kit . . . . .                   | 43                     | Control Arm . . . . .                          | 111                              | Dash Knob Set . . . . .                      | 40                                  | Door Hinge Detent Kit . . . . .             | 48      |
| Clutch Alignment Tool . . . . .            | 195                    | Control Arm Bumper . . . . .                   | 112                              | Dash Pads . . . . .                          | 38                                  | Door Hinge Pins . . . . .                   | 48      |
| Clutch Bellcrank, Z-Bar . . . . .          | 149                    | Control Arm Bushing . . . . .                  | 110                              | Dash Pad Clips . . . . .                     | 38                                  | Door Hinge Spring . . . . .                 | 48      |
| Clutch Bellcrank Push Rod . . . . .        | 150                    | Control Arm Cam Bolts . . . . .                | 110                              | Dash Pad Plastic Shell . . . . .             | 38                                  | Door Jamb Rubber . . . . .                  | 53      |
| Clutch Bellcrank Seat & Clip Kit . . . . . | 149                    | Control Arm Shaft Kit . . . . .                | 110                              | Dash Panel, Steel . . . . .                  | 137                                 | Door Jamb Sticker, GM . . . . .             | 200     |
| Clutch Cover / Pressure Plate . . . . .    | 194                    | Control Arm Strut Rod . . . . .                | 110                              | Dash Panel Trim Set . . . . .                | 39                                  | Door Jamb Switch . . . . .                  | 28      |
| Clutch Fork . . . . .                      | 150                    | Control Arm Strut Rod Bushings . . . . .       | 110                              | Dash Top Panel . . . . .                     | 137                                 | Door Jamb Windlace . . . . .                | 18      |
| Clutch Fork Boot . . . . .                 | 151                    | Control Arm Strut Rod Nut Kit . . . . .        | 110                              | Dash Vent Outlet . . . . .                   | 45                                  | Door Jamb Windlace End Caps . . . . .       | 18      |
| Clutch Fork Push Rod . . . . .             | 149                    | Convertible Door Wedges . . . . .              | 51                               | Decals . . . . .                             | 197-202, 208                        | Door Latch Clip . . . . .                   | 45      |
| Clutch Fork Push Rod Swivel . . . . .      | 149                    | Convertible Pillar Post Weatherstrip . . . . . | 54                               | Defroster Duct . . . . .                     | 45                                  | Door Latch Mechanism . . . . .              | 47      |
| Clutch Kit . . . . .                       | 194                    | Convertible Top . . . . .                      | 50                               | Defroster Switch Bezel . . . . .             | 43                                  | Door Latch Mechanism Screws . . . . .       | 47      |
| Clutch Linkage Parts . . . . .             | 148-150                | Convertible Top Boots . . . . .                | 51                               | Differential Cover . . . . .                 | 116                                 | Door Latch Mechanism Spring . . . . .       | 47      |
|  |                        |  |                                  | Differential Cover Bolt Kit . . . . .        | 116                                 | Door Lock Set . . . . .                     | 156     |

# P A R T S I N D E X

|  |         |   |         |  |         |  |       |
|--|---------|---|---------|--|---------|--|-------|
| Door Lock Cylinder Gasket . . . . .        | 157     | Exhaust Manifold Bolt Locks . . . . .       | 169     | Four Speed Shifter . . . . .             | 34      | Gas Tank Insulation Kit . . . . .        | 143   |
| Door Lock Ferrules . . . . .               | 18      | Exhaust Manifold Gaskets . . . . .          | 169     | Four Speed Shift Rods . . . . .          | 34-35   | Gas Tank Mounting Straps & Bolts . .     | 144   |
| Door Lock Knobs . . . . .                  | 18      | Exhaust Manifold Heat Stove . . . . .       | 169     | Four-Way Hazard Flasher Switch . . .     | 102     | Gas Tank Sending Unit . . . . .          | 145   |
| Door Lock Pawl . . . . .                   | 157     | Exhaust Manifold Heat Stove Rivets .        | 169     | Frame, Subframe . . . . .                | 112     | Gas Tank Sending Unit Filter . . . . .   | 144   |
| Door Lock Pawl Retainer . . . . .          | 157     | Exhaust Manifold Smog Hole Plugs .          | 169     | Frame Rails, Rear . . . . .              | 143     | Gas Tank Sending Unit Gasket . . . . .   | 144   |
| Door Lock Rod . . . . .                    | 18      | Exhaust Manifold Studs . . . . .            | 169     | Frame Side Pivot Ball Bracket . . . . .  | 150     | Gas Tank Sending Unit Lock Ring . .      | 144   |
| Door Lock Striker Bolt . . . . .           | 47      | Exterior Screw Kits . . . . .               | 67      | Freeze Plug Sets . . . . .               | 179     | Gas Tank Sending Unit Tool . . . . .     | 145   |
| Door Lock Switch . . . . .                 | 18      | Eyebrow Moldings . . . . .                  | 69      | Fresh Air Vent Knobs & Cables . . . . .  | 44      | Gas Tank Sending Unit Wire . . . . .     | 144   |
| Door Opening Body Panel . . . . .          | 138     | <b>F</b>                                    |         | Front Bumper Guards . . . . .            | 75      | Gas Tank Straps . . . . .                | 144   |
| Door Opening Rod Hardware . . . . .        | 45      | Fact Book . . . . .                         | 205     | Front Brake Line Sets . . . . .          | 131     | Gas Tank Vent Valve . . . . .            | 144   |
| Door Panels . . . . .                      | 12-17   | Fan Blade . . . . .                         | 163     | Front End Fastener Kits . . . . .        | 133     | Gasket, Antenna . . . . .                | 82    |
| Door Panel Emblem . . . . .                | 17      | Fan Blade Bolts . . . . .                   | 164     | Front End Rebuild Kit . . . . .          | 110-111 | Gasket, Differential Cover . . . . .     | 116   |
| Door Panel Installation Clip Kit . . . . . | 17      | Fan Caution Decal . . . . .                 | 199     | Front Seat Floor Bracket . . . . .       | 9       | Gasket, Exhaust Manifold . . . . .       | 169   |
| Door Panel Mounting Plugs . . . . .        | 17      | Fan Clutch . . . . .                        | 164     | Front to Rear Brake Line . . . . .       | 177     | Gasket, Fuel Sending Unit . . . . .      | 144   |
| Door Panel Mounting Screw Kit . . . . .    | 17      | Fan Shroud . . . . .                        | 163     | Fuel Blocks . . . . .                    | 176     | Gasket, Header . . . . .                 | 168   |
| Door Panel Moldings . . . . .              | 12      | Fan Shroud Mounting Bracket . . . . .       | 163     | Fuel Filter . . . . .                    | 176     | Gasket, Intake Manifold . . . . .        | 179   |
| Door Panel Retainer, Screw Kit . . . . .   | 12      | Fan Shroud Mounting Clips . . . . .         | 163     | Fuel Filter Bracket . . . . .            | 176     | Gasket, License Light . . . . .          | 59    |
| Door Panel Water Shields . . . . .         | 17      | Fan Spacer . . . . .                        | 164     | Fuel Filter Decal . . . . .              | 200     | Gasket, Master Cylinder . . . . .        | 123   |
| Door Sill Plates . . . . .                 | 23      | Fender . . . . .                            | 137     | Fuel Gauge . . . . .                     | 36,42   | Gasket, Mirror . . . . .                 | 50    |
| Door Skins & Shells . . . . .              | 138     | Fender Bolts . . . . .                      | 133-134 | Fuel Hose & Clamp Kit . . . . .          | 176     | Gasket, Oil Pan . . . . .                | 188   |
| Door Weatherstrip . . . . .                | 52      | Fender Brace Rods . . . . .                 | 137     | Fuel Lines . . . . .                     | 177     | Gasket, Parking Light Lens . . . . .     | 60    |
| Door Window Glass Run Channel . . . . .    | 53      | Fender Emblems . . . . .                    | 64-65   | Fuel Line Clips . . . . .                | 132     | Gasket, Side Marker Light Lens . . . . . | 59    |
| Door Window Lower Stop . . . . .           | 47      | Fender Eyebrow Moldings . . . . .           | 69      | Fuel Line Guide Bracket . . . . .        | 177     | Gasket, Tail Light Lens . . . . .        | 62-63 |
| Door Window Rollers . . . . .              | 47      | Fender Patch Panel . . . . .                | 138     | Fuel Line Inlet Kit, Edelbrock . . . . . | 174     | Gasket, Thermostat Housing . . . . .     | 180   |
| Draglink, Steering . . . . .               | 108     | Fender Seals . . . . .                      | 54      | Fuel Line Inlet Kit, Holley . . . . .    | 174     | Gasket, Timing Cover . . . . .           | 191   |
| Drip Rail Support . . . . .                | 140     | Fender Skirt, Front Inner . . . . .         | 138     | Fuel Pressure Gauge . . . . .            | 175     | Gasket, Valve Cover . . . . .            | 184   |
| Drop Spindle . . . . .                     | 125     | Fender Skirt, Front Outer . . . . .         | 138     | Fuel Pressure Gauge Adapter . . . . .    | 175     | Gasket, Wiper Motor . . . . .            | 159   |
| <b>E</b>                                   |         | Fender Skirt to Firewall Brace . . . . .    | 138     | Fuel Pressure Regulator . . . . .        | 174     | Gasket Set, Paint Seal . . . . .         | 55    |
| Eibach Coil Springs . . . . .              | 113     | Fiber Optic Vigilite Bezel . . . . .        | 88      | Fuel Pump . . . . .                      | 175-176 | Gauges, Console . . . . .                | 36    |
| Electrical Terminal Nuts . . . . .         | 90      | Filler Neck Hose . . . . .                  | 144     | Fuel Pump Block Off Plate . . . . .      | 175     | Gauges, Dash . . . . .                   | 41-42 |
| Emblem, Console . . . . .                  | 35      | Filter, Fuel Tank Sending Unit . . . . .    | 144     | Fuel Pump Gasket . . . . .               | 176     | Gauge Cluster, Dash . . . . .            | 42    |
| Emblem, Dash . . . . .                     | 39      | Firewall . . . . .                          | 137     | Fuel Pump Gas Line . . . . .             | 176     | Gauge Conversion Kit . . . . .           | 41    |
| Emblem, Door Panel . . . . .               | 17      | Firewall to Floor Brace . . . . .           | 137     | Fuel Pump Mounting Bolts . . . . .       | 176     | Gauge Mounting Plate, Console . . . . .  | 37    |
| Emblem, Fender . . . . .                   | 64-65   | Firewall Cowl Seal Kit . . . . .            | 54      | Fuel Pump Mounting Plate . . . . .       | 176     | Gauge Resistors . . . . .                | 36    |
| Emblem, Grill . . . . .                    | 64      | Firewall Clutch Rod Boot . . . . .          | 150     | Fuel Pump Push Rod . . . . .             | 176     | Gear Box, Seals . . . . .                | 107   |
| Emblem, Hood . . . . .                     | 64      | Firewall Clutch Rod Hole Cover . . . . .    | 150     | Fuel Recommendation Decal . . . . .      | 200     | Gear Box, Steering . . . . .             | 107   |
| Emblem, Horn Cap . . . . .                 | 98-99   | Firewall Insulation Pad . . . . .           | 24      | Fuel Tank & Related . . . . .            | 143-144 | Generator Warning Tag . . . . .          | 201   |
| Emblem, Hub Cap . . . . .                  | 118-119 | Firewall Insulation Pad Fasteners . . . . . | 24      | Fuel Tank Sending Unit Filter . . . . .  | 144     | Glass . . . . .                          | 57-58 |
| Emblem, Rear Panel . . . . .               | 66      | Firewall Plastic Guard . . . . .            | 24      | Fuel Vapor Can Bolt Kit . . . . .        | 174     | Glass Frame Weatherstrip . . . . .       | 52    |
| Emblem, Seat Belt . . . . .                | 21      | Firewall to Floor Brace . . . . .           | 137     | Fuse Box To Firewall Bolts . . . . .     | 87      | Glass Run Channel Seal . . . . .         | 52,53 |
| Emblem, Seat Upholstery . . . . .          | 10      | Fisher Body Manual . . . . .                | 204     | Fuzzy Dice & 8-Balls . . . . .           | 206     | Glass Setting Tape . . . . .             | 56    |
| Emblem, Steering Wheel . . . . .           | 98-99   | Flame Arrestor, Air Cleaner . . . . .       | 172     | <b>G</b>                                 |         | Glove Box . . . . .                      | 37    |
| Emblem, Trunk Lid . . . . .                | 65      | Flasher, Turn Signal . . . . .              | 96      | Gas Caps . . . . .                       | 144     | Glove Box Bumpers . . . . .              | 37,55 |
| Engine Bolt Kits . . . . .                 | 182     | Flexplate . . . . .                         | 195     | Gas Filler Hose . . . . .                | 144     | Glove Box Catch Plate . . . . .          | 38    |
| Engine Cooling System Decal . . . . .      | 199     | Flexplate Bolt Kit . . . . .                | 195     | Gas Filler Neck . . . . .                | 144     | Glove Box Door . . . . .                 | 38    |
| Engine Ground Strap Kits . . . . .         | 89      | Floor Insulation . . . . .                  | 22      | Gas Line . . . . .                       | 177     | Glove Box Door Emblem . . . . .          | 39    |
| Engine Harness . . . . .                   | 84      | Floor Mats . . . . .                        | 23      | Gas Pedal . . . . .                      | 145     | Glove Box Door Screw Kit . . . . .       | 38    |
| Engine Lift Bracket Kit . . . . .          | 179     | Floor Pan . . . . .                         | 142     | Gas Pedal Firewall Support . . . . .     | 146     | Glove Box Light . . . . .                | 38    |
| Engine Mounting Brackets . . . . .         | 151     | Floor Pan Brace . . . . .                   | 142     | Gas Pedal Linkage Kit . . . . .          | 146     | Glove Box Lock . . . . .                 | 157   |
| Engine Side Covers . . . . .               | 182     | Floor Pan Cross Rail Filler . . . . .       | 142     | Gas Pedal Mounting Studs . . . . .       | 145     | Glove Box Lock Retainer . . . . .        | 157   |
| Engine Side Cover Gaskets . . . . .        | 184     | Floor Pan Rear Cross Rail . . . . .         | 142     | Gas Pedal Support Hardware . . . . .     | 146     | Glove Box Screw Kit . . . . .            | 37    |
| Exhaust Clamps . . . . .                   | 170     | Floor Pan Steel Plug . . . . .              | 143     | Gas Pedal Tension Spring . . . . .       | 145     | Grease Cap . . . . .                     | 120   |
| Exhaust Hanger Kit . . . . .               | 170     | Floor Shifter Release Button . . . . .      | 30      | Gas Pedal to Rod Pin . . . . .           | 145     | Grills . . . . .                         | 69    |
| Exhaust Headpipe Extension . . . . .       | 170     | Floor Shift Hump . . . . .                  | 33      | Gas Pedal Rod . . . . .                  | 146     | Grill Bracket Kit . . . . .              | 69    |
| Exhaust Heat Riser Gasket . . . . .        | 170     | Flywheel . . . . .                          | 195     | Gas Pedal Rod to Firewall Bushing .      | 146     | Grill Emblems . . . . .                  | 64    |
| Exhaust Heat Riser Valve . . . . .         | 170     | Flywheel Bolt Kit . . . . .                 | 195     | Gas Pedal Tension Spring . . . . .       | 145     | Grill Fastener Kit . . . . .             | 70    |
| Exhaust Manifold . . . . .                 | 169     | Flywheel Covers . . . . .                   | 195-196 | Gas Tank . . . . .                       | 143-144 | Grill Guard . . . . .                    | 75    |
| Exhaust Manifold Bolts . . . . .           | 169     | Forward Lamp Harness . . . . .              | 85      | Gas Tank Braces . . . . .                | 141     | Grill Moldings . . . . .                 | 69    |
|  |         | Four Speed Pedals . . . . .                 | 149     | Gas Tank Door . . . . .                  | 145     | Grill Rivets . . . . .                   | 70    |

# P A R T S I N D E X

|  |       |  |        |   |         |   |         |
|--|-------|--|--------|---|---------|---|---------|
| Grease Fittings . . . . .                      | 109   | Heater / A/C Control Panel . . . . .     | 43     | Horn Cap Retainer & Contact Kit . . . . .   | 99      | Kick Panel Cable Clips . . . . .          | 11      |
| Grease Fittings Plugs . . . . .                | 109   | Heater / A/C Fan Switch . . . . .        | 43     | Horn Contacts . . . . .                     | 100     | Kick Panel Screw Kit . . . . .            | 11      |
| Grommets . . . . .                             | 56    | Heater Blower Motor . . . . .            | 156    | Horn Contact Wire . . . . .                 | 97,103  | Kick Panel Support Brace . . . . .        | 139     |
| Ground Straps, Engine . . . . .                | 89    | Heater Blower Motor Relay . . . . .      | 156    | Horn Mounting Bolts . . . . .               | 94      | Kick Panel Vent Cables . . . . .          | 11      |
| Ground Wire Star Washers . . . . .             | 89    | Heater Blower Motor Resistor . . . . .   | 156    | Horn Pin, Spring & Retainer Kit . . . . .   | 99      | Kick Panel With Speakers . . . . .        | 11      |
| <b>H</b>                                       |       |  |        |   |         |   |         |
| Harmonic Balancer . . . . .                    | 191   | Heater Box . . . . .                     | 152    | Horn Relay . . . . .                        | 94      | Kick Down Cable & Bracket . . . . .       | 29      |
| Harmonic Balancer Bolt & Washer . . . . .      | 191   | Heater Box Delete Plate . . . . .        | 152    | Horsepower Decals . . . . .                 | 197-198 | Kick Down Kit . . . . .                   | 29      |
| Harmonic Balancer Chrome Cover . . . . .       | 191   | Heater Box Fastener Kit . . . . .        | 152    | Hose, Air Duct . . . . .                    | 44      | Kick Down Linkage . . . . .               | 29      |
| Handle, Exterior Door . . . . .                | 47    | Heater Box Seal Kits . . . . .           | 152    | Hose Clamps . . . . .                       | 164     | Kick Down Switch Bracket . . . . .        | 29      |
| Handle, Interior Door . . . . .                | 45    | Heater Cables . . . . .                  | 44     | Hose Kit, Convertible Top . . . . .         | 51      | Knob, Headlight Switch . . . . .          | 94      |
| Handle, Plastic Washer Plate . . . . .         | 46    | Heater Control Knobs . . . . .           | 43     | Hub Caps . . . . .                          | 118-119 | Knob, Seat Track Adjuster . . . . .       | 10      |
| Handle, Vent Window . . . . .                  | 46    | Heater Control Lever . . . . .           | 43     | Hub Cap Inserts . . . . .                   | 118-119 | Knob, Wiper Switch . . . . .              | 158     |
| Handle, Window Crank . . . . .                 | 46    | Heater Control Panel Screw Kit . . . . . | 44     | Hub Cap Spinners . . . . .                  | 118     | <b>L</b>                                  |         |
| Handle Clip, Interior . . . . .                | 46    | Heater Control Valve . . . . .           | 153    | Hydraulic Assist Power Brake Kits . . . . . | 128     | Labels . . . . .                          | 198-202 |
| Handle Spring, Interior . . . . .              | 46    | Heater Core . . . . .                    | 152    | <b>I</b>                                    |         |   |         |
| Handle Removal Tool . . . . .                  | 46    | Heater Core Box . . . . .                | 152    | Ice Chest . . . . .                         | 205     | Leaf Spring . . . . .                     | 114     |
| Harness Tape . . . . .                         | 88    | Heater Core Pipe Grommet . . . . .       | 152    | Idler Arm . . . . .                         | 108-109 | Leaf Spring Eye Bushing . . . . .         | 115     |
| Hats . . . . .                                 | 207   | Heater Delete Plates . . . . .           | 152    | Idler Arm Bolts . . . . .                   | 109     | Leaf Spring Bolts . . . . .               | 115     |
| Hazard Flasher Switch . . . . .                | 102   | Heater Duct . . . . .                    | 45     | Idler Arm Bushings . . . . .                | 109     | Leaf Spring Mounting Pads . . . . .       | 115     |
| Hazard Knob . . . . .                          | 101   | Heater Hose Fittings . . . . .           | 182    | Idler Arm Frame Bracket . . . . .           | 108     | Leaf Spring Mounting Kits . . . . .       | 115     |
| Headers, Exhaust . . . . .                     | 168   | Heater Hose Kit . . . . .                | 165    | Ignition & Door Lock Set . . . . .          | 157     | Leaf Spring Perches . . . . .             | 116     |
| Header Gasket Sets . . . . .                   | 168   | Heater Hose Clamps . . . . .             | 164    | Ignition Bezel Nut . . . . .                | 40,95   | Leaf Spring Rebuild Kit . . . . .         | 115     |
| Headlight Assembly Fastener Kit . . . . .      | 67    | Heater Hose Bracket . . . . .            | 165    | Ignition Bezel Nut Tool . . . . .           | 95      | Leaf Spring & Shock Mount Plate . . . . . | 115     |
| Headlight Adjusters . . . . .                  | 68    | Heater Tube to Box Cover Plate . . . . . | 153    | Ignition Coil . . . . .                     | 92      | Leaf Spring Shackle Bushing . . . . .     | 114     |
| Headlight Bezel . . . . .                      | 68    | Heater Tube Seal . . . . .               | 152    | Ignition Dash Bezel . . . . .               | 95      | Leaf Spring Shackle Kit . . . . .         | 114     |
| Headlight Bezel Screws . . . . .               | 68    | Heat Riser Valve, Exhaust . . . . .      | 170    | Ignition Lock Cylinders . . . . .           | 95,156  | L.E.D. Back-up Light Lens . . . . .       | 61      |
| Headlight Bezel Seals . . . . .                | 54    | Heat Shield Jute Padding . . . . .       | 22     | Ignition Module, H.E.I. . . . .             | 93      | L.E.D. Tail Light Lens . . . . .          | 61      |
| Headlight Bezel Fastener Kit . . . . .         | 68    | H.E.I. Distributor . . . . .             | 90-91  | Ignition Switch . . . . .                   | 95      | Lens, Back-up Light . . . . .             | 62      |
| Headlight Bezel Nuts . . . . .                 | 68    | H.E.I. Engine Harness . . . . .          | 84     | Ignition Switch Dash Bezel . . . . .        | 40      | Lens, Dome Light . . . . .                | 28      |
| Headlight Bucket . . . . .                     | 67    | H.E.I. Lead Wire & Pigtail . . . . .     | 93     | Inner Door Lock Bellcrank Clip . . . . .    | 18      | Lens, License Light . . . . .             | 59      |
| Headlight Bulb . . . . .                       | 67    | Holley Fuel Fitting . . . . .            | 174    | Inner Door Lock Rod . . . . .               | 18      | Lens, Park Light . . . . .                | 60      |
| Headlight Bulb Mounting Bucket . . . . .       | 67    | Hood . . . . .                           | 136    | Inner Door Lock Rod . . . . .               | 18      | Lens, Shift Indicator . . . . .           | 30,32   |
| Headlight Bulb Pigtail . . . . .               | 67    | Hood Adjuster Bolts . . . . .            | 56     | Inner Fender Assembly . . . . .             | 138     | Lens, Side Marker Light . . . . .         | 59      |
| Headlight Bulb Retaining Ring . . . . .        | 67    | Hood Bumpers . . . . .                   | 56     | Inner Fender Assembly Bolt Kit . . . . .    | 138     | Lens, Speedometer . . . . .               | 39      |
| Headlight Bulb Retaining Ring Screws . . . . . | 67    | Hood Emblem . . . . .                    | 64     | Intake Fitting, Heater Hose . . . . .       | 182     | Lens, Screws . . . . .                    | 63      |
| Headlight Dimmer Pigtail . . . . .             | 94    | Hood Hinge . . . . .                     | 135    | Intake Manifolds . . . . .                  | 178     | Lens, Tail Light . . . . .                | 61      |
| Headlight Dimmer Switch . . . . .              | 94    | Hood Hinge Bolt Kit . . . . .            | 135    | Intake Manifold Bolt Kit . . . . .          | 178     | License Plates . . . . .                  | 77      |
| Headlight Housing . . . . .                    | 67    | Hood Hinge Spring . . . . .              | 135    | Intake Manifold Gasket Sets . . . . .       | 179     | License Plate Bolts With Lights . . . . . | 77      |
| Headlight Knob and Rod . . . . .               | 94    | Hood Inserts & Seals . . . . .           | 136    | Intake Manifold Stud . . . . .              | 185     | License Plate Bracket . . . . .           | 76      |
| Headlight Mud Caps . . . . .                   | 67    | Hood Insulation Kit . . . . .            | 136    | Intake Manifold T-Fittings . . . . .        | 126     | License Plate Bracket Bolts . . . . .     | 76      |
| Headlight Switch . . . . .                     | 93    | Hood Latch & Hardware . . . . .          | 135    | Interior Paint . . . . .                    | 196     | License Plate Bullets . . . . .           | 77      |
| Headlight Switch Retaining Nut . . . . .       | 93    | Hood Latch Catch Assembly . . . . .      | 136    | Interior Rear View Mirror . . . . .         | 48      | License Plate Bumpers . . . . .           | 76      |
| Headlight Switch Nut Tool . . . . .            | 93    | Hood Latch Support . . . . .             | 135    | Interior Screw Kits . . . . .               | 20      | License Plate Frames . . . . .            | 77      |
| Headliner . . . . .                            | 25-26 | Hood Light . . . . .                     | 85     | Inverted Flare Plugs . . . . .              | 131     | License Plate Nut & Screw . . . . .       | 76      |
| Headliner Bows & Clips . . . . .               | 24    | Hood Lip Molding . . . . .               | 69     | I-pod Connector . . . . .                   | 78      | License Plate Rubber Bumpers . . . . .    | 76      |
| Headliner Installation Tool . . . . .          | 24    | Hood Split Molding . . . . .             | 69     | <b>J</b>                                    |         |   |         |
| Headliner Retaining Strips . . . . .           | 24    | Hood Springs . . . . .                   | 135    | J-Nuts . . . . .                            | 133     | License Plate Lamp . . . . .              | 59      |
| Headliner Reveal Molding Clips . . . . .       | 26    | Hood Stop Bolts . . . . .                | 56     | J-Strap, Wiring . . . . .                   | 87      | License Plate Lamp Lens . . . . .         | 59      |
| Headliner Windlace . . . . .                   | 26    | Hood to Cowl Ground Clip . . . . .       | 89     | Jack . . . . .                              | 77      | License Plate Lens Gasket . . . . .       | 59      |
| Headrest Assembly . . . . .                    | 10    | Hood to Cowl Seal . . . . .              | 54     | Jack Base Decal . . . . .                   | 198     | Light Bulbs . . . . .                     | 67,87   |
| Headrest Covers . . . . .                      | 10    | Horns . . . . .                          | 94     | Jacking Instructions Decal . . . . .        | 198     | Linkage, Column Shift . . . . .           | 29,30   |
| Headrest Escutcheon Screw Kit . . . . .        | 11    | Horn Button . . . . .                    | 98     | Junction Block, Wiring . . . . .            | 87      | Linkage, Kickdown . . . . .               | 29      |
| Headrest Guide Set . . . . .                   | 11    | Horn Button Contacts . . . . .           | 98-99  | Jute Padding . . . . .                      | 22      | Linkage, Shifter, 4-Speed . . . . .       | 34-35   |
| Headrest Lock Assembly . . . . .               | 11    | Horn Cap . . . . .                       | 98     | <b>K</b>                                    |         |   |         |
| Headrest Mounting Kit . . . . .                | 10    | Horn Cap Contact . . . . .               | 99-100 | Key Blanks . . . . .                        | 156     | Literature . . . . .                      | 202-205 |
| Headrest Lock Assembly . . . . .               | 11    | Horn Cap Emblems . . . . .               | 98-99  | Key Chains . . . . .                        | 206     | Locking Gas Cap . . . . .                 | 144     |
| Heater / A/C Control Lenses . . . . .          | 44    | Horn Cap Mounting Kit . . . . .          | 99     | Kick Panel . . . . .                        | 11      | Lock Washer . . . . .                     | 133     |
|  |       | Horn Cap Mounting Ring . . . . .         | 99     | Kick Panel Actuator Cover . . . . .         | 12      | Lock Retainers . . . . .                  | 157-158 |
|  |       | Horn Cap Retainer . . . . .              | 98     |   |         | Lock Sets . . . . .                       | 156-157 |
|  |       |  |        |   |         | Lug Wrench . . . . .                      | 77      |
|  |       |  |        |   |         | Lug Nuts . . . . .                        | 120     |
|  |       |  |        |   |         | Lug Studs . . . . .                       | 120     |

# P A R T S I N D E X

|   |  |          |
|---|--|----------|
| <b>M</b>                                    | Oil Filter Decal . . . . .                 | 201      |
| Maintenance Schedule Folder . . . . .       | Oil Gauge Block Fitting . . . . .          | 37       |
| Marker Light . . . . .                      | Oil Gauge Oil Line . . . . .               | 37       |
| Marker Light Pigtail . . . . .              | Oil Gauge Oil Line Block Fitting . . . . . | 37       |
| Master Body Fastener Kit . . . . .          | Oil Pan . . . . .                          | 187-188  |
| Master Chassis Fastener Kits . . . . .      | Oil Pan Baffle . . . . .                   | 188      |
| Master Cylinder . . . . .                   | Oil Pan Baffle Bolts . . . . .             | 188      |
| 122-123                                     | Oil Pan Bolt Kit . . . . .                 | 188      |
| Master Cylinder Cover . . . . .             | Oil Pan Drain Plug . . . . .               | 188      |
| 123   | Oil Pan Gasket Set . . . . .               | 188      |
| Master Cylinder Cover Seal . . . . .        | Oil Pressure Sending Unit . . . . .        | 179      |
| 123   | Oil Pump . . . . .                         | 189      |
| Master Cylinder Gasket . . . . .            | Oil Pump Bolt . . . . .                    | 189      |
| 123   | Oil Pump Drive Shaft . . . . .             | 189      |
| Master Cylinder Hardware . . . . .          | Oil Pump Pickup Main Cap Bolt . . . . .    | 189      |
| 123   | Oil Pump Pickup & Screen . . . . .         | 189      |
| Master Cylinder/Prop Valve Kit . . . . .    | Optikleen Bottle . . . . .                 | 159      |
| 129   | Optikleen Bottle Decals . . . . .          | 200      |
| Master Cylinder Push Rod . . . . .          | Owners Manual . . . . .                    | 204      |
| 123,126                                     | Owners Service Policy . . . . .            | 202      |
| Mastic Sealer Washers . . . . .             |  |          |
| 56  | <b>P</b>                                   |          |
| Mirror Bracket, Interior . . . . .          | Package Tray . . . . .                     | 24       |
| 49  | Package Tray Jute Padding . . . . .        | 24       |
| Mirror Bracket, Exterior . . . . .          | Package Tray Panel . . . . .               | 142      |
| 50  | Paint . . . . .                            | 196      |
| Mirror, Exterior . . . . .                  | Paint Seal Gasket Kits . . . . .           | 55       |
| 50  | Paint Warning Decal . . . . .              | 200      |
| Mirror, Interior . . . . .                  | Patch Panels . . . . .                     | 137-142  |
| 48-49                                       | Parking Brake Cable . . . . .              | 131      |
| Mirror, Vanity . . . . .                    | Parking Brake Cable Clip . . . . .         | 131      |
| 49  | Parking Brake Cable Connectors . . . . .   | 131      |
| Mirror Hardware, Side View . . . . .        | Parking Brake Cable Supports . . . . .     | 131      |
| 50  | Parking Brake Catch Pawl Kit . . . . .     | 130      |
| Molding, Body Side . . . . .                | Parking Brake Light Switch . . . . .       | 130      |
| 71  | Parking Brake Pedal Assembly . . . . .     | 130      |
| Molding, Dash Trim . . . . .                | Parking Brake Pedal Pad . . . . .          | 148      |
| 39  | Parking Brake Release Handle . . . . .     | 130      |
| Molding, Door Panel . . . . .               | Parking Brake Shoe Lever Kit . . . . .     | 121      |
| 12  | Parking Brake Springs . . . . .            | 121      |
| Molding, Grill . . . . .                    | Parking Brake to Dash Hardware . . . . .   | 130      |
| 69  | Parking Light Assembly . . . . .           | 60       |
| Molding, Quarter Pillar, Interior . . . . . | Parking Light Bezels . . . . .             | 60       |
| 18  | Parking Light Extension Moldings . . . . . | 69       |
| Molding, Quarter Window . . . . .           | Parking Light Lens . . . . .               | 60       |
| 73  | Parking Light Lens Gasket . . . . .        | 60       |
| Molding, Rear Cove Panel . . . . .          | Parking Light Lens Trim Rings . . . . .    | 60       |
| 72  | Parking Light Pigtail . . . . .            | 60       |
| Molding, Rear Window . . . . .              | Parking Light Wire Grommets . . . . .      | 60       |
| 73  | PCV Valve . . . . .                        | 186      |
| Molding, Rocker Panel . . . . .             | PCV Valve Hose Clamp . . . . .             | 187      |
| 71  | PCV Valve Hose Kit . . . . .               | 186      |
| Molding, Roof Drip . . . . .                | PCV Valve Hose Retainer . . . . .          | 187      |
| 72  | Pedal Pads . . . . .                       | 147-148  |
| Molding, Trunk Lid . . . . .                | Pigtail, Light Socket . . . . .            | 59,60,86 |
| 72  | Pillar Post Covers . . . . .               | 18       |
| Molding, Vinyl Top . . . . .                | Pillar Post Weatherstrip . . . . .         | 54       |
| 70  | Pilot Bearing . . . . .                    | 195      |
| Molding, Wheel Opening . . . . .            | Pinch Clamps . . . . .                     | 164      |
| 70  |  |          |
| Molding, Windshield . . . . .               |  |          |
| 73  |  |          |
| Molding Clips . . . . .                     |  |          |
| 73-74                                       |  |          |
| Molding Clips Nuts . . . . .                |  |          |
| 74  |  |          |
| Molding Removal Tool . . . . .              |  |          |
| 73  |  |          |
| Motor Mount . . . . .                       |  |          |
| 151   |  |          |
| Motor Mount Bolt Kit . . . . .              |  |          |
| 151   |  |          |
| Motor Mount Brackets . . . . .              |  |          |
| 151   |  |          |
| Muffler . . . . .                           |  |          |
| 170   |  |          |
|   |  |          |
| <b>N</b>                                    |  |          |
| Neutral Safety Switch . . . . .             |  |          |
| 31  |  |          |
| Neutral Safety Switch Harness . . . . .     |  |          |
| 31  |  |          |
| Neutral Safety Switch Linkage Rod . . . . . |  |          |
| 32  |  |          |
| Neutral Safety Switch Pivot . . . . .       |  |          |
| 31  |  |          |
|   |  |          |
| <b>O</b>                                    |  |          |
| Oil Breather Cap . . . . .                  |  |          |
| 186   |  |          |
| Oil Dip Stick Delete Plug . . . . .         |  |          |
| 190   |  |          |
| Oil Dip Stick & Tube . . . . .              |  |          |
| 190   |  |          |
| Oil Filler Plug . . . . .                   |  |          |
| 186   |  |          |
| Oil Filler Tube . . . . .                   |  |          |
| 185   |  |          |
| Oil Filler Tube Cap . . . . .               |  |          |
| 186   |  |          |
| Oil Filter . . . . .                        |  |          |
| 189   |  |          |
| Oil Filter Adapter Kit . . . . .            |  |          |
| 189   |  |          |
| Oil Filter Bypass Valve . . . . .           |  |          |
| 189   |  |          |
| Oil Filter Bypass Valve Bolt Kit . . . . .  |  |          |
| 189   |  |          |

|   |         |
|---|---------|
| Pinion Bumper . . . . .                     | 116     |
| Pitman Arm . . . . .                        | 108     |
| Pitman Arm Nut & Lock Washer . . . . .      | 108     |
| Pivot Ball Seat . . . . .                   | 149     |
| Plastic Hole Plugs . . . . .                | 56      |
| Plastic Wiring Gutter . . . . .             | 86      |
| POA Valve Update Kit . . . . .              | 153     |
| Points, Distributor . . . . .               | 91      |
| Positraction Decal . . . . .                | 198     |
| Power Brake Booster . . . . .               | 126,128 |
| Power Brake Booster Hardware . . . . .      | 126     |
| Power Brake Booster Dust Boot . . . . .     | 126     |
| Power Brake Booster Hose Kit . . . . .      | 126     |
| Power Brake Manifold T-Fitting . . . . .    | 126     |
| Power Disc Brake Conversion Kit . . . . .   | 127     |
| Power Door Lock Switch . . . . .            | 18      |
| Power Steering Control Valve . . . . .      | 106     |
| Power Steering Control Valve Boot . . . . . | 106     |
| Power Steering Coupler . . . . .            | 107     |
| Power Steering Cylinder . . . . .           | 106     |
| Power Steering Cylinder Mount Kit . . . . . | 106     |
| Power Steering Gear Box . . . . .           | 107     |
| Power Steering Gear Box Seals . . . . .     | 107     |
| Power Steering Hoses . . . . .              | 106     |
| Power Steering Hose Brackets . . . . .      | 106     |
| Power Steering Hose Clips . . . . .         | 105     |
| Power Steering Pitman Arm . . . . .         | 108     |
| Power Steering Pulley Nut . . . . .         | 105     |
| Power Steering Pump . . . . .               | 105     |
| Power Steering Pump Bracket . . . . .       | 104     |
| Power Steering Pump Bracket Bolts . . . . . | 105     |
| Power Steering Pump Cap . . . . .           | 105     |
| Power Steering Pump Pulley . . . . .        | 106     |
| Power Steering Pump Seal Kit . . . . .      | 105     |
| Pre-Lube, For Urethane Products . . . . .   | 114     |
| Primer . . . . .                            | 196     |
| Printed Circuit Board . . . . .             | 42      |
| Proportioning Valves . . . . .              | 129-130 |
| Pulley, Crank Shaft . . . . .               | 191-192 |
| Pulley, Power Steering Pump . . . . .       | 106     |
| Push On Flat Nuts . . . . .                 | 74      |
| Push In Clips . . . . .                     | 74      |
|   |         |
| <b>Q</b>                                    |         |
| Quarter Panel . . . . .                     | 139     |
| Quarter Panel Emblems . . . . .             | 65      |
| Quarter Panel Patch Panels . . . . .        | 139-140 |
| Quarter Trim Panels, Interior . . . . .     | 12-17   |
| Quarter Window Channel Kit . . . . .        | 53      |
| Quarter Window Chrome Frame . . . . .       | 73      |
| Quarter Window Glass . . . . .              | 58      |
| Quarter Window Guides . . . . .             | 47      |
| Quarter Window Corner Moldings . . . . .    | 72      |
| Quarter Window Molding . . . . .            | 73      |
| Quarter Window Weatherstrip . . . . .       | 53      |

|   |                     |     |
|---|---------------------|-----|
| <b>R</b>                                | Radiators . . . . . | 161 |
| Radiator Cap . . . . .                  | 160                 |     |
| Radiator Hose . . . . .                 | 162                 |     |
| Radiator Hose Clamps . . . . .          | 164                 |     |
| Radiator Mounting Kit . . . . .         | 161                 |     |
| Radiator Mounting Pads . . . . .        | 162                 |     |
| Radiator Mounting Panel . . . . .       | 162                 |     |
| Radiator Overflow Hose . . . . .        | 160                 |     |
| Radiator Overflow Hose Clip . . . . .   | 160                 |     |
| Radiator Overflow Jar . . . . .         | 160,161             |     |
| Radiator Overflow Jar Cap . . . . .     | 160                 |     |
| Radiator Petcock . . . . .              | 161                 |     |
| Radiator Support . . . . .              | 162                 |     |
| Radiator Support Bushing Kit . . . . .  | 162                 |     |
| Radiator Support Filler Seal . . . . .  | 162                 |     |
| Radiator Support Frame Braces . . . . . | 162                 |     |
| Radiator Upper Mounting Panel . . . . . | 162                 |     |
| Radio . . . . .                         | 79-80               |     |
| Radio Bezel . . . . .                   | 39                  |     |
| Radio Capacitor . . . . .               | 78                  |     |
| Radio Color Bar . . . . .               | 80                  |     |
| Radio Delete Plate . . . . .            | 78                  |     |
| Radio Knobs . . . . .                   | 80                  |     |
| Radio Lens . . . . .                    | 78                  |     |
| Radio Retaining Nuts . . . . .          | 80                  |     |
| Radio Support Brace . . . . .           | 78                  |     |
| Rally Wheel . . . . .                   | 117                 |     |
| Rally Wheel Hub Caps . . . . .          | 118-119             |     |
| Rear Arm Rest Covers . . . . .          | 17                  |     |
| Rear Axle Bumpers . . . . .             | 116                 |     |
| Rear Axle Pinion Seal . . . . .         | 117                 |     |
| Rear Axle Retainer Bolt Kit . . . . .   | 125                 |     |
| Rear Body Panel . . . . .               | 139                 |     |
| Rear Body To Bumper Seal . . . . .      | 55                  |     |
| Rear Brake Line Kit . . . . .           | 132                 |     |
| Rear Bumper Guards . . . . .            | 75                  |     |
| Rear Disc Brake Kit . . . . .           | 130                 |     |
| Rear End Overhaul Kit . . . . .         | 116                 |     |
| Rear Frame Rail Brace . . . . .         | 143                 |     |
| Rear Light Harness . . . . .            | 85                  |     |
| Rear Panel Emblem . . . . .             | 66                  |     |
| Rear Seat Bolts . . . . .               | 8                   |     |
| Rear Seat Floor Bracket . . . . .       | 8                   |     |
| Rear Seat Floor Pan . . . . .           | 142                 |     |
| Rear Trim Panel . . . . .               | 66                  |     |
| Rear View Mirror . . . . .              | 48-49               |     |
| Rear View Mirror Bracket . . . . .      | 49                  |     |
| Rear Window . . . . .                   | 58                  |     |
| Rear Window Seal . . . . .              | 52                  |     |
| Rear Window Defroster Harness . . . . . | 86                  |     |
| Rear Window Moldings . . . . .          | 73                  |     |
| Rear Window Molding Clips . . . . .     | 73                  |     |
| Rear Window Panel . . . . .             | 140                 |     |
| Relay, Horn . . . . .                   | 94                  |     |
| Remote Mirror Parts . . . . .           | 50                  |     |
| Retainer, Brake Light Switch . . . . .  | 95                  |     |
| Retainer, Spring Clip . . . . .         | 150                 |     |
| Retractors, Seat Belt . . . . .         | 21                  |     |



# P A R T S I N D E X

|   |         |  |       |  |           |  |         |
|---|---------|--|-------|--|-----------|--|---------|
| Retrosound Radios . . . . .                   | 79      | Shift Lever, 4-Speed . . . . .               | 35    | Spark Plug Wire Looms . . . . .            | 88-89     | Sun Visor Screw Kit . . . . .            | 26      |
| Reveal Molding Clips, Interior . . . . .      | 26      | Shift Lever Swivel Kit . . . . .             | 28    | Speaker Harness . . . . .                  | 86        | Sun Visor Support Brackets . . . . .     | 26      |
| Reverse Lock Out Parts . . . . .              | 34      | Shift Linkage . . . . .                      | 28-30 | Speakers . . . . .                         | 81        | Sun Visor Tip Kit . . . . .              | 26      |
| Rocker Panel . . . . .                        | 139     | Shift Plate Assembly . . . . .               | 32    | Speedometer . . . . .                      | 41        | Sway Bar . . . . .                       | 114     |
| Rocker Panel Moldings . . . . .               | 71      | Shift Plate Insert . . . . .                 | 32    | Speedometer Cable . . . . .                | 41        | Sway Bar Hardware . . . . .              | 114     |
| Rocker Panel Molding Clips . . . . .          | 71      | Shift Rods . . . . .                         | 34-35 | Speedometer Cable Clip . . . . .           | 41        | Sway Bar Bushings . . . . .              | 114     |
| Roof Drip Connector . . . . .                 | 72      | Shifter, 4 Speed . . . . .                   | 34    | Speedometer Cable Grommet . . . . .        | 41        | Sway Bar End Link Kits . . . . .         | 114     |
| Roof Drip Molding . . . . .                   | 72      | Shifter, Automatic . . . . .                 | 31    | Speedometer Gear . . . . .                 | 41        | Switch, Back-Up Light . . . . .          | 31      |
| Roof Drip Rail Supports . . . . .             | 140     | Shifter Arm . . . . .                        | 28-29 | Speedometer Lens . . . . .                 | 39        | Switch, Dome Light . . . . .             | 28      |
| Roof Panel . . . . .                          | 140     | Shifter Assembly . . . . .                   | 31    | Spindle . . . . .                          | 125       | Switch, Head Light . . . . .             | 93      |
| Roof Panel Brace Kit . . . . .                | 140     | Shifter Ball . . . . .                       | 34    | Spindle Bolts . . . . .                    | 124       | Switch, Ignition . . . . .               | 95      |
| Roof Rail Retainer Screws . . . . .           | 20      | Shifter Boot . . . . .                       | 33    | Spindle Nut & Washer . . . . .             | 125       | Switch, Turn Signal . . . . .            | 101     |
| Roof Rail Weatherstrip . . . . .              | 52      | Shifter Boot Retainer . . . . .              | 33    | Splash Flaps, A-Arm . . . . .              | 56        | Switch, Windshield Wiper . . . . .       | 158     |
| Rotor, Disc Brake . . . . .                   | 125     | Shifter Cable . . . . .                      | 29    | Spray Adhesive . . . . .                   | 22,52     |  |         |
| Rotor, Distributor . . . . .                  | 91      | Shifter Cable Installation Kit . . . . .     | 29    | Spring, Clutch Return . . . . .            | 149       | <b>T</b>                                 |         |
| Rubber Bumpers . . . . .                      | 55-56   | Shifter Cable Pin . . . . .                  | 29    | Spring, Gas Pedal . . . . .                | 145       | T-Fittings, Intake . . . . .             | 126     |
| Rubber Bumper Kit . . . . .                   | 56      | Shifter Detent Conversion Kit . . . . .      | 29    | Spring, Seat Support . . . . .             | 8         | T-Shirts . . . . .                       | 207     |
|   |         | Shifter Handle . . . . .                     | 30    | Square Nut Inserts . . . . .               | 133       | Tachometer . . . . .                     | 42      |
| <b>S</b>                                      |         | Shifter Handle Repair Parts . . . . .        | 30    | Starter . . . . .                          | 165       | Tachometer Harness . . . . .             | 86      |
| Sail Panels . . . . .                         | 26      | Shifter Handle Release Button . . . . .      | 30    | Starter Brace . . . . .                    | 165       | Tailgate Bumpers . . . . .               | 56      |
| Sales Brochure . . . . .                      | 205     | Shifter Handle Seal . . . . .                | 33    | Starter Hardware . . . . .                 | 165       | Tailgate Glass Setting Channel . . . . . | 47      |
| Screw, Interior . . . . .                     | 20      | Shifter Handle Slider . . . . .              | 32    | Starter Rebuild Kit . . . . .              | 165       | Tail Light Assemblies . . . . .          | 62      |
| Screw, Lenses . . . . .                       | 63      | Shifter Handle Slider Retainers . . . . .    | 32    | Starter Solenoid . . . . .                 | 165       | Tail Light Blue Dots . . . . .           | 61      |
| Screw, Sunvisor Supports . . . . .            | 26      | Shifter Knob . . . . .                       | 30,34 | Starter Solenoid Heat Shield . . . . .     | 166       | Tail Light Body Seals . . . . .          | 63      |
| Seal, Wheel Bearing . . . . .                 | 120     | Shifter Knob, Chrome Skull . . . . .         | 206   | Station Wagon Window Seals . . . . .       | 53        | Tail Light Harness . . . . .             | 85      |
| Sealer Washers . . . . .                      | 56      | Shifter Linkage . . . . .                    | 28-30 | Steering Arms . . . . .                    | 108       | Tail Light Housing . . . . .             | 62      |
| Seat Back Bumpers . . . . .                   | 10      | Shifter Stabilizer . . . . .                 | 34    | Steering Box . . . . .                     | 107       | Tail Light Housing Seal . . . . .        | 63      |
| Seat Back Cable Screw . . . . .               | 10      | Shifter to Floor Hardware . . . . .          | 37    | Steering Box Bolt Kit . . . . .            | 107       | Tail Light Lens . . . . .                | 61      |
| Seat Back Panels . . . . .                    | 8-9     | Shims, Front Suspension . . . . .            | 112   | Steering Box Inspection Decal . . . . .    | 201       | Tail Light Lens Gasket . . . . .         | 62      |
| Seat Back Release Button . . . . .            | 9       | Shocks . . . . .                             | 113   | Steering Column . . . . .                  | 102-103   | Tail Light Lens Reflector . . . . .      | 62      |
| Seat Belts . . . . .                          | 20-21   | Shock Mount Reinforcement . . . . .          | 141   | Steering Column Bearing . . . . .          | 100       | Tail Light Lens Screws . . . . .         | 63      |
| Seat Belt Anchor Plate . . . . .              | 20      | Shock Mounting Bolt . . . . .                | 113   | Steering Column Cover Panel . . . . .      | 39        | Tail Light Nut Kit . . . . .             | 62      |
| Seat Belt Bolts . . . . .                     | 20      | Shock Mounting Kit . . . . .                 | 113   | Steering Column to Dash Hardware . . . . . | 100       | Tail Light Panel . . . . .               | 139     |
| Seat Belt Buckle Cover . . . . .              | 21      | Shock Mounting Towers . . . . .              | 113   | Steering Column to Dash Plate . . . . .    | 100,102   | Tail Light Patch Panel . . . . .         | 139     |
| Seat Belt Instruction Card . . . . .          | 199     | Shock Tower Panel . . . . .                  | 138   | Steering Column Lock Rod Kit . . . . .     | 29        | Tail Light Socket . . . . .              | 86      |
| Seat Belt Emblem . . . . .                    | 21      | Shop Manual . . . . .                        | 204   | Steering Column Lower Bushing . . . . .    | 100       | TCS Solenoid & Relay . . . . .           | 86      |
| Seat Belt Retractors . . . . .                | 21      | Shoulder Harness Retainer . . . . .          | 22    | Steering Column Lower Cover . . . . .      | 39        | TCS Wire Clip . . . . .                  | 86      |
| Seat Emblems . . . . .                        | 10      | Side Air Outlet Vents . . . . .              | 44    | Steering Column Rubber Boot . . . . .      | 100       | Temperature Control Knobs . . . . .      | 43      |
| Seat Foam . . . . .                           | 8       | Side Marker Bezel . . . . .                  | 59    | Steering Column Sponge Seal . . . . .      | 100       | Temperature Sender Wire . . . . .        | 179     |
| Seat Frame Assembly . . . . .                 | 8       | Side Marker Light . . . . .                  | 59    | Steering Coupler . . . . .                 | 107       | Temperature Sending Unit . . . . .       | 179     |
| Seat Frame Support Brackets . . . . .         | 9       | Side Marker Light Gaskets . . . . .          | 59    | Steering Coupler Hardware . . . . .        | 107       | TH400 Kickdown Harness . . . . .         | 85      |
| Seat Pivot E-Clip Kit . . . . .               | 10      | Side Marker Light Pigtail . . . . .          | 59    | Steering Coupler Repair Kit . . . . .      | 107       | TH700R4 Shifter Conversion Kit . . . . . | 29      |
| Seat Side Bracket Covers . . . . .            | 10      | Sill Plates . . . . .                        | 23    | Steering Stops . . . . .                   | 111       | Thermostat . . . . .                     | 180     |
| Seat Support Springs . . . . .                | 8       | Smog Pump Bracket . . . . .                  | 168   | Steering Wheel . . . . .                   | 96-97,103 | Thermostat Housing . . . . .             | 180     |
| Seat Tracks . . . . .                         | 9       | Smog Pump Diverter Elbow . . . . .           | 168   | Steering Wheel Horn Buttons . . . . .      | 98-99     | Thermostat Housing Bolt Kit . . . . .    | 180     |
| Seat Track Adjuster Knob . . . . .            | 10      | Smog Pump Fan . . . . .                      | 168   | Steering Wheel Hub . . . . .               | 99,103    | Thermostat Housing Gasket . . . . .      | 180     |
| Seat Track Nut Kit . . . . .                  | 9       | Smog Pump Pulley . . . . .                   | 168   | Steering Wheel Shroud . . . . .            | 98        | Thread Cutting Nuts . . . . .            | 74      |
| Seat Upholstery . . . . .                     | 2-7     | Sound Deadener . . . . .                     | 22    | Steering Wheel Shroud Emblems . . . . .    | 99        | Threaded Plugs . . . . .                 | 133,182 |
| Seat Upholstery Emblems . . . . .             | 10      | Spare Tire Anchor Plate . . . . .            | 77    | Stereos . . . . .                          | 79-80     | Throttle Arm . . . . .                   | 146     |
| Seat Upholstery Installation Kit . . . . .    | 7       | Spare Tire Cover . . . . .                   | 78    | Stoplight Switch . . . . .                 | 95        | Throttle Arm Pinch Bolt Kit . . . . .    | 146     |
| Self Adjuster Repair Kits . . . . .           | 120     | Spare Tire Inflator Bottle Bracket . . . . . | 77    | Stoplight Switch Retainer . . . . .        | 95        | Throttle Cable . . . . .                 | 147     |
| Service Manual . . . . .                      | 204     | Spare Tire Lock Instruction Sheet . . . . .  | 200   | Strut Rod . . . . .                        | 110       | Throttle Cable Bracket . . . . .         | 147     |
| Service Policy Sheet . . . . .                | 202     | Spare Tire Rod . . . . .                     | 77    | Strut Rod Bushings . . . . .               | 110       | Throttle Cable Retainer . . . . .        | 147     |
| Service Record Decal . . . . .                | 199     | Spare Tire Rod Wing Nut . . . . .            | 77    | Strut Rod Nut Kit . . . . .                | 110       | Throttle Rod . . . . .                   | 145     |
| Shackle Bushing . . . . .                     | 114     | Spark Plugs . . . . .                        | 89    | Sub-Frame . . . . .                        | 112       | Throttle Return Spring . . . . .         | 147     |
| Sheet Metal . . . . .                         | 136-143 | Spark Plug Wires . . . . .                   | 88    | Sub-Frame A-Arm Kit . . . . .              | 111       | Throttle Return Spring Bracket . . . . . | 147     |
| Sheet Metal Hole Plugs . . . . .              | 143     | Spark Plug Wire Clips . . . . .              | 88    | Sub-Frame Body Mount Bushings . . . . .    | 112       | Throwout Bearing . . . . .               | 195     |
| Shift Indicator Lamp Mounting Plate . . . . . | 33      | Spark Plug Wire Heat Shields . . . . .       | 89    | Subwoofer . . . . .                        | 81        |  |         |
| Shift Indicator Lens . . . . .                | 30,32   | Spark Plug Wire Retainers . . . . .          | 88    | Sun Visor . . . . .                        | 27        |  |         |

# P A R T S I N D E X

|  |         |   |             |  |         |   |       |
|--|---------|---|-------------|--|---------|---|-------|
| Tie Rod . . . . .                            | 108     | Trunk Lid Guide Plates . . . . .            | 158         | Vent Window Glass Frame . . . . .          | 46      | Window Molding Clip Pin Stud . . . . .      | 73    |
| Tie Rod Adjusting Sleeve . . . . .           | 108     | Trunk Lid Moldings . . . . .                | 72          | Vent Window Handles . . . . .              | 46      | Window Molding Removal Tool . . . . .       | 73    |
| Tie Rod Boot . . . . .                       | 108     | Trunk Light Kit . . . . .                   | 86          | Vent Window Pivot Rivet . . . . .          | 46      | Window Regulator . . . . .                  | 47    |
| Tilt Columns . . . . .                       | 102-103 | Trunk Lock . . . . .                        | 157         | Vent Window Weatherstrip . . . . .         | 53      | Window Regulator Roller . . . . .           | 47    |
| Tilt Column Filler Plate . . . . .           | 103     | Trunk Lock Gasket . . . . .                 | 157         | Vinyl Top . . . . .                        | 52      | Window Seal . . . . .                       | 52    |
| Tilt Column Release Lever . . . . .          | 96      | Trunk Lock Retainer . . . . .               | 157         | Vinyl Top Molding . . . . .                | 52,70   | Window Sticker . . . . .                    | 202   |
| Tilt Column Wiring Adapters . . . . .        | 86      | Trunk Lock Shaft . . . . .                  | 158         | Volt Gauge . . . . .                       | 36      | Window, Rear . . . . .                      | 58    |
| Timing Chain Covers . . . . .                | 190     | Trunk Lock Spring . . . . .                 | 158         | Voltage Regulator . . . . .                | 95      | Windshield . . . . .                        | 58    |
| Timing Chain Cover Bolt Kit . . . . .        | 191     | Trunk Lock Shaft . . . . .                  | 158         | Voltage Regulator Bolts . . . . .          | 95      | Windshield Lower Support . . . . .          | 73    |
| Timing Chain Cover Pointer . . . . .         | 190     | Trunk Mat . . . . .                         | 78          | Voltage Regulator Ground Wire . . . . .    | 95      | Windshield Molding . . . . .                | 73    |
| Timing Chain Cover Gasket set . . . . .      | 191     | Trunk Pan Steel Plug . . . . .              | 143         | Voltage Regulator Mounting Kit . . . . .   | 95      | Window Molding Clips . . . . .              | 73    |
| Tire Inflator Decal . . . . .                | 201     | Trunk Spatter Paint . . . . .               | 78,196      |  |         | Windshield Pillars . . . . .                | 140   |
| Tire Pressure Decal . . . . .                | 199     | Trunk Spring Rods . . . . .                 | 140         |  |         | Windshield Seal . . . . .                   | 52    |
| Tissue Dispenser . . . . .                   | 41      | Trunk Weatherstrip . . . . .                | 53          | <b>W</b>                                   |         | Windshield Washer Hose Kit . . . . .        | 159   |
| Tissue Dispenser Refill . . . . .            | 42      | Tubular Control Arms . . . . .              | 111         | Warranty Sheet . . . . .                   | 202     | Windshield Washer Jar Cap . . . . .         | 158   |
| Torque Converter Bolt Kit . . . . .          | 195     | Tune-Up Labels . . . . .                    | 201-202     | Washer Fluid Pump . . . . .                | 159     | Windshield Washer Jar Bracket . . . . .     | 159   |
| Torque Converter Lock-up Kit . . . . .       | 196     | Turn Signal Cancelling Cam . . . . .        | 100         | Washer Fluid Pump Repair Kit . . . . .     | 159     | Windshield Washer Jar Filter . . . . .      | 158   |
| Traction Bars . . . . .                      | 116     | Turn Signal Flasher . . . . .               | 96          | Washer Jar . . . . .                       | 159     | Windshield Washer Jar Bracket . . . . .     | 159   |
| Transmission Bolt Kit . . . . .              | 195     | Turn Signal Lever . . . . .                 | 96          | Washer Jar Bracket Bolts . . . . .         | 159     | Windshield Washer Jar Filter . . . . .      | 158   |
| Transmission Books . . . . .                 | 203     | Turn Signal Lever Screw . . . . .           | 96          | Washer Nozzle Bolts . . . . .              | 159     | Windshield Washer Jar Kit . . . . .         | 159   |
| Transmission Cable Bracket . . . . .         | 29      | Turn Signal Ring Pivot Bolt . . . . .       | 101         | Water Neck . . . . .                       | 180     | Windshield Washer Nozzles . . . . .         | 159   |
| Transmission Crossmember . . . . .           | 194     | Turn Signal Switch . . . . .                | 101         | Water Pump . . . . .                       | 180-181 | Windshield Wiper Arms . . . . .             | 160   |
| Transmission Crossmember Brace . . . . .     | 142     | Turn Signal Switch Repair Cam . . . . .     | 101         | Water Pump Backing Plate Bolt . . . . .    | 181     | Windshield Wiper Blades . . . . .           | 160   |
| Transmission Mount . . . . .                 | 151,194 |   |             | Water Pump Bolt Kit . . . . .              | 181     | Windshield Wiper Motor . . . . .            | 160   |
| Transmission Mount Bolt Kit . . . . .        | 194     | <b>U</b>                                    |             | Water Pump Bypass Hose . . . . .           | 182     | Windshield Wiper Motor Arm . . . . .        | 160   |
| Transmission Oil Cooler Lines . . . . .      | 193     | U-Bolts . . . . .                           | 115         | Water Pump Heater Hose Fittings . . . . .  | 182     | Windshield Wiper Motor Grommets . . . . .   | 160   |
| Transmission Oil Cooler Line Clips . . . . . | 193     | U-Joint U-Bolts . . . . .                   | 117         | Water Pump Pulley . . . . .                | 181     | Windshield Wiper Motor Pump . . . . .       | 159   |
| Transmission Oil Filter Kit . . . . .        | 193     | U-Seals, Door Jamb . . . . .                | 53          | Water Pump Pulley Reinforcement . . . . .  | 181     | Windshield Wiper Motor Seal . . . . .       | 159   |
| Transmission Oil Pan . . . . .               | 192-193 | Under Dash Lights . . . . .                 | 28          | Water Pump Rebuild Kit . . . . .           | 181     | Windshield Wiper Optikleen Bottle . . . . . | 159   |
| Transmission Oil Pan Bolt Kit . . . . .      | 192     | Under Hood Fastener Kits . . . . .          | 133         | Weatherstrip . . . . .                     | 52-56   | Windshield Wiper Switch . . . . .           | 158   |
| Transmission Oil Pan Gasket . . . . .        | 193     | Unleaded Gasoline Only Decal . . . . .      | 200         | Weatherstrip Adhesive . . . . .            | 53      | Windshield Wiper Switch Knob . . . . .      | 158   |
| Transmission Oil Dipstick . . . . .          | 193     | Universal Joint . . . . .                   | 117         | Weatherstrip Kit . . . . .                 | 55      | Windshield Wiper Switch Nut . . . . .       | 158   |
| Transmission Oil Dipstick & Tube . . . . .   | 194     | Upholstery . . . . .                        | 2-7         | Well Nut, Voltage Regulator . . . . .      | 95      | Windshield Wiper Switch Nut Tool . . . . .  | 158   |
| Transmission Shifter Arm . . . . .           | 28      | Upholstery Installation Kit . . . . .       | 7           | Wheels . . . . .                           | 117     | Wing Nut, Air Cleaner . . . . .             | 172   |
| Transmission Vacuum Line . . . . .           | 193     | Upper Door Window Stops . . . . .           | 53          | Wheel Bearings and Seals . . . . .         | 120     | Wiper Motor . . . . .                       | 160   |
| Transmission Vacuum Modulator . . . . .      | 193     |   |             | Wheel Bearing Grease Cap . . . . .         | 120     | Wiper Motor Arm with Ball Stud . . . . .    | 160   |
| Trim Rings, Wheel . . . . .                  | 117     | <b>V</b>                                    |             | Wheel Cylinder . . . . .                   | 122     | Wiper Motor Harness . . . . .               | 86    |
| Trunk Divider . . . . .                      | 24      | Vacuum Advance . . . . .                    | 93          | Wheel Cylinder Bolts . . . . .             | 122     | Wiper Motor Seal . . . . .                  | 159   |
| Trunk Divider Panel . . . . .                | 142     | Vacuum Advance Hose & Tube Kit . . . . .    | 93          | Wheel Cylinder Push Rod . . . . .          | 122     | Wiper Shaft Chrome Bullets . . . . .        | 160   |
| Trunk Floor . . . . .                        | 141     | Vacuum Advance Line . . . . .               | 93          | Wheel Cylinder Repair Kit . . . . .        | 122     | Wiper Transmission Assembly . . . . .       | 160   |
| Trunk Floor Brace . . . . .                  | 141     | Vacuum Advance Line Retainer Clip . . . . . | 93          | Wheelhouse Panel, Rear . . . . .           | 140     | Wiper Transmission Bolt Kit . . . . .       | 160   |
| Trunk Floor Drop Off Panel . . . . .         | 141     | Vacuum Booster Pipe . . . . .               | 126         | Wheel Opening Molding . . . . .            | 70      | Wire Looms, Spark Plug . . . . .            | 88    |
| Trunk Floor Extension . . . . .              | 141     | Valve Covers . . . . .                      | 182-184     | Wheel Opening Screw Kit . . . . .          | 71      | Wiring Diagram . . . . .                    | 204   |
| Trunk Floor Shock Tower Panel . . . . .      | 141     | Valve Cover-to-Air Cleaner Hose . . . . .   | 187         | Wheel Trim Rings . . . . .                 | 117     | Wiring Harness . . . . .                    | 83-86 |
| Trunk Gutter Side Brace . . . . .            | 141     | Valve Cover Bolts . . . . .                 | 185         | Wheel Trim Ring Instruction Card . . . . . | 200     | Wiring Harness Clips . . . . .              | 87    |
| Trunk Hinges . . . . .                       | 140     | Valve Cover Decal . . . . .                 | 183,197,198 | Windlace End Caps . . . . .                | 18      | Wiring Harness Straps . . . . .             | 87    |
| Trunk Latch Bolt Kit . . . . .               | 158     | Valve Cover Elbow . . . . .                 | 187         | Window Guide Roller . . . . .              | 47      | Wiring Harness Seal . . . . .               | 86    |
| Trunk Latch Bracket . . . . .                | 140     | Valve Cover Gaskets . . . . .               | 184         | Window Channel Liner . . . . .             | 52      | Wiring Harness Tape . . . . .               | 88    |
| Trunk Latch Catch . . . . .                  | 158     | Valve Cover Grommets . . . . .              | 187         | Window Crank Handle . . . . .              | 46      | Wiring Harness Seal . . . . .               | 86    |
| Trunk Latch Mechanism . . . . .              | 158     | Valve Cover Hold-Down Tabs . . . . .        | 185         | Window Crank Knobs . . . . .               | 46      | Wiring Gutter . . . . .                     | 86    |
| Trunk Lid . . . . .                          | 140     | Valve Cover Retainers With Bolts . . . . .  | 185         | Window Crank Handle Washer . . . . .       | 46      | Wiring Junction Block . . . . .             | 87    |
| Trunk Lid Bolt Kit . . . . .                 | 140     | Valve Cover Retainers With Bolts . . . . .  | 185         | Window Crank Handle Washer . . . . .       | 46      |   |       |
| Trunk Lid Bumpers . . . . .                  | 55      | Valve Stem Caps . . . . .                   | 120         | Window Felt Clips . . . . .                | 54      |   |       |
| Trunk Lid Emblems . . . . .                  | 65      | Vanity Mirror . . . . .                     | 49          | Window Felt Kit . . . . .                  | 54      |   |       |
|  |         | Vent Cables . . . . .                       | 11          | Window Lower Support Clip, Front . . . . . | 73      | <b>Y</b>                                    |       |
|  |         | Vent Window . . . . .                       | 57          | Window Molding Clip Kit . . . . .          | 73      | Yenco Sales Sheet . . . . .                 | 205   |

# CHEVROLET NOVA PARTS



Car Shop Inc. 739 North Batavia Orange, California 92868

TRUCK SHOP / CAR SHOP



CAR SHOP



ORANGE CA.

**Car Shop Inc.**

is proud to be a full line

**FARGO  
AUTOMOTIVE  
DEALER**

Look for the Fargo logo featured throughout the catalog!



**Best Quality! – Best Price!**



**Car Shop California**  
739 North Batavia Orange CA 92868



**Car Shop North Carolina.**  
2701 Derita Road Concord NC 28027  
704-979-6490 Fax: 704-979-5157



**ORDER YOUR FREE CATALOG TODAY!**



|                               |                               |                       |           |                  |                           |                           |                           |               |                |                 |
|-------------------------------|-------------------------------|-----------------------|-----------|------------------|---------------------------|---------------------------|---------------------------|---------------|----------------|-----------------|
| 1941-194                      | 1958-1972                     | 1964-1972             | 1967-1972 | 1962-1974        | 1947-1959                 | 1960-1972                 | 1973-1979                 | 1948-1966     | 1966-1966      | 1964-1973       |
| CHEVROLET<br>PASSENGER<br>CAR | CHEVROLET<br>PASSENGER<br>CAR | CHEVELLE<br>EL CAMINO | CAMARO    | CHEVY II<br>NOVA | CHEVROLET<br>GMC<br>TRUCK | CHEVROLET<br>GMC<br>TRUCK | CHEVROLET<br>GMC<br>TRUCK | FORD<br>TRUCK | FORD<br>BRONCO | FORD<br>MUSTANG |



# CHEVROLET NOVA PARTS

Car Shop Inc. 739 North Batavia Orange, California 92868

## 1962-1964 CHEVY II/NOVA SS SEAT UPHOLSTERY



### Front Buckets

Made from Seville grain vinyl.

|          |       |            |       |           |     |
|----------|-------|------------|-------|-----------|-----|
| 63-51001 | 62-64 | Black      | ..... | \$ 299.00 | pr. |
| 63-51002 | 63-64 | Red        | ..... | \$ 299.00 | pr. |
| 63-51003 | 62-64 | Light Blue | ..... | \$ 299.00 | pr. |
| 63-51004 | 62-64 | Aqua       | ..... | \$ 299.00 | pr. |
| 63-51005 | 62-64 | White      | ..... | \$ 299.00 | pr. |
| 63-51006 | 62-64 | Saddle     | ..... | \$ 299.00 | pr. |
| 63-51007 | 62    | Bright Red | ..... | \$ 299.00 | pr. |
| 63-51008 | 62-63 | Fawn       | ..... | \$ 299.00 | pr. |
| 63-51009 | 64    | Light Fawn | ..... | \$ 299.00 | pr. |



### Front Split Bench

Made from Seville grain vinyl.

|          |       |            |       |           |     |
|----------|-------|------------|-------|-----------|-----|
| 62-51041 | 62-64 | Black      | ..... | \$ 299.00 | ea. |
| 62-51042 | 63-64 | Red        | ..... | \$ 299.00 | ea. |
| 62-51043 | 62-64 | Light Blue | ..... | \$ 299.00 | ea. |
| 62-51044 | 62-64 | Aqua       | ..... | \$ 299.00 | ea. |
| 62-51045 | 62-64 | White      | ..... | \$ 299.00 | ea. |
| 62-51046 | 62-64 | Saddle     | ..... | \$ 299.00 | ea. |
| 62-51047 | 62    | Bright Red | ..... | \$ 299.00 | ea. |
| 62-51048 | 62-63 | Fawn       | ..... | \$ 299.00 | ea. |
| 62-51049 | 64    | Light Fawn | ..... | \$ 299.00 | ea. |



Does your interior look like this?

## 1962-1964 CHEVY II/NOVA SS SEAT UPHOLSTERY



### Rear Bench, Convertible

Made from Seville grain vinyl.

|          |       |            |       |           |     |
|----------|-------|------------|-------|-----------|-----|
| 63-51021 | 62-63 | Black      | ..... | \$ 175.00 | ea. |
| 63-51022 | 63    | Red        | ..... | \$ 175.00 | ea. |
| 63-51023 | 62-63 | Light Blue | ..... | \$ 175.00 | ea. |
| 63-51024 | 62-63 | Aqua       | ..... | \$ 175.00 | ea. |
| 63-51025 | 62-63 | White      | ..... | \$ 175.00 | ea. |
| 63-51026 | 62-63 | Saddle     | ..... | \$ 175.00 | ea. |
| 63-51027 | 62    | Bright Red | ..... | \$ 175.00 | ea. |
| 63-51028 | 62-63 | Fawn       | ..... | \$ 175.00 | ea. |



### Rear Bench, 2-Door Hardtop

Made from Seville grain vinyl.

|          |       |            |       |           |     |
|----------|-------|------------|-------|-----------|-----|
| 63-51011 | 63-64 | Black      | ..... | \$ 175.00 | ea. |
| 63-51012 | 63-64 | Red        | ..... | \$ 175.00 | ea. |
| 63-51013 | 63-64 | Light Blue | ..... | \$ 175.00 | ea. |
| 63-51014 | 63-64 | Aqua       | ..... | \$ 175.00 | ea. |
| 63-51015 | 63-64 | White      | ..... | \$ 175.00 | ea. |
| 63-51016 | 63-64 | Saddle     | ..... | \$ 175.00 | ea. |
| 62-51017 | 62    | Bright Red | ..... | \$ 175.00 | ea. |
| 63-51018 | 63    | Fawn       | ..... | \$ 175.00 | ea. |
| 63-51019 | 64    | Light Fawn | ..... | \$ 175.00 | ea. |

### Rear Bench, 2-Door Sedan

Made from Seville grain vinyl.

|          |       |            |       |           |     |
|----------|-------|------------|-------|-----------|-----|
| 62-51051 | 62-64 | Black      | ..... | \$ 259.00 | ea. |
| 62-51052 | 63-64 | Red        | ..... | \$ 259.00 | ea. |
| 62-51053 | 62-64 | Light Blue | ..... | \$ 259.00 | ea. |
| 62-51054 | 62-64 | Aqua       | ..... | \$ 259.00 | ea. |
| 62-51055 | 62-64 | White      | ..... | \$ 259.00 | ea. |
| 62-51056 | 62-64 | Saddle     | ..... | \$ 259.00 | ea. |
| 62-51057 | 62    | Bright Red | ..... | \$ 259.00 | ea. |
| 62-51058 | 62-63 | Fawn       | ..... | \$ 259.00 | ea. |
| 62-51059 | 64    | Light Fawn | ..... | \$ 259.00 | ea. |

## 1963 2-DOOR SEAT UPHOLSTERY WITH CLOTH INSERTS

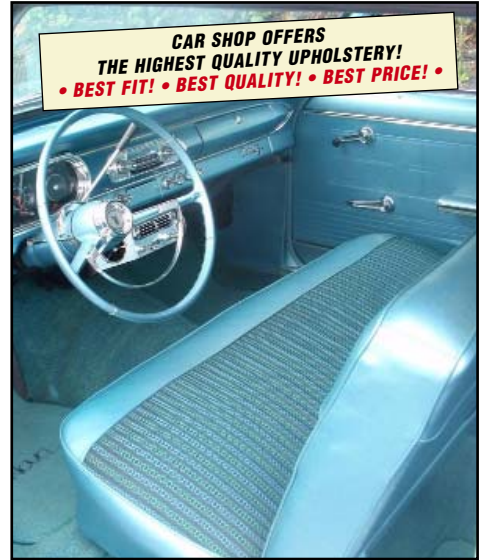

### Front & Rear set, with cloth inserts.

Complete sets are for 2-door hardtop models only. Set includes front split bench and rear bench seat covers. will fit 1962-1964 seats.

|          |    |        |       |           |     |
|----------|----|--------|-------|-----------|-----|
| 63-51031 | 63 | Red    | ..... | \$ 729.00 | ea. |
| 63-51032 | 63 | Blue   | ..... | \$ 729.00 | ea. |
| 63-51033 | 63 | Aqua   | ..... | \$ 729.00 | ea. |
| 63-51034 | 63 | Saddle | ..... | \$ 729.00 | ea. |
| 63-51035 | 63 | Fawn   | ..... | \$ 729.00 | ea. |



Just down the hall from Car Shop is Truck Shop.  
1947-91 Chevy & GMC truck parts.

# CHEVROLET NOVA PARTS



Car Shop Inc. 739 North Batavia Orange, California 92868

## 1962-1964 4-DOOR SEDAN OR WAGON SEAT UPHOLSTERY



### Front Straight Bench

Made from Seville grain vinyl.

|          |       |            |       |           |     |
|----------|-------|------------|-------|-----------|-----|
| 62-51061 | 62-64 | Black      | ..... | \$ 299.00 | ea. |
| 62-51062 | 62-64 | Red        | ..... | \$ 299.00 | ea. |
| 62-51063 | 62-64 | Light Blue | ..... | \$ 299.00 | ea. |
| 62-51064 | 62-64 | Aqua       | ..... | \$ 299.00 | ea. |
| 62-51065 | 62-64 | White      | ..... | \$ 299.00 | ea. |
| 62-51066 | 62-64 | Saddle     | ..... | \$ 299.00 | ea. |
| 63-51067 | 62    | Bright Red | ..... | \$ 299.00 | ea. |
| 62-51068 | 62-63 | Fawn       | ..... | \$ 299.00 | ea. |
| 62-51069 | 64    | Light Fawn | ..... | \$ 299.00 | ea. |

### Rear Bench, 4-Door Sedan

Made from Seville grain vinyl.

|          |       |            |       |           |     |
|----------|-------|------------|-------|-----------|-----|
| 62-51071 | 62-64 | Black      | ..... | \$ 259.00 | ea. |
| 62-51072 | 62-64 | Red        | ..... | \$ 259.00 | ea. |
| 62-51073 | 62-64 | Light Blue | ..... | \$ 259.00 | ea. |
| 62-51074 | 62-64 | Aqua       | ..... | \$ 259.00 | ea. |
| 62-51075 | 62-64 | White      | ..... | \$ 259.00 | ea. |
| 62-51076 | 62-64 | Saddle     | ..... | \$ 259.00 | ea. |
| 62-51077 | 62    | Bright Red | ..... | \$ 259.00 | ea. |
| 62-51078 | 62-63 | Fawn       | ..... | \$ 259.00 | ea. |
| 62-51079 | 64    | Light Fawn | ..... | \$ 259.00 | ea. |

### Rear Bench, 4-Door Station Wagon

Made from Seville grain vinyl.

|          |       |            |       |           |     |
|----------|-------|------------|-------|-----------|-----|
| 62-51081 | 62-64 | Black      | ..... | \$ 259.00 | ea. |
| 62-51082 | 62-64 | Red        | ..... | \$ 259.00 | ea. |
| 62-51083 | 62-64 | Light Blue | ..... | \$ 259.00 | ea. |
| 62-51084 | 62-64 | Aqua       | ..... | \$ 259.00 | ea. |
| 62-51085 | 62-64 | White      | ..... | \$ 259.00 | ea. |
| 62-51086 | 62-64 | Saddle     | ..... | \$ 259.00 | ea. |
| 62-51087 | 62    | Bright Red | ..... | \$ 259.00 | ea. |
| 62-51088 | 62-63 | Fawn       | ..... | \$ 259.00 | ea. |
| 62-51089 | 64    | Light Fawn | ..... | \$ 259.00 | ea. |



## 1965 CHEVY II/NOVA SS SEAT UPHOLSTERY



### Front Buckets

Made from Madrid grain vinyl.

|          |    |              |       |           |     |
|----------|----|--------------|-------|-----------|-----|
| 65-51101 | 65 | Black        | ..... | \$ 229.00 | pr. |
| 65-51102 | 65 | Red          | ..... | \$ 229.00 | pr. |
| 65-51103 | 65 | Light Blue   | ..... | \$ 229.00 | pr. |
| 65-51104 | 65 | Aqua         | ..... | \$ 229.00 | pr. |
| 65-51106 | 65 | Light Saddle | ..... | \$ 229.00 | pr. |
| 65-51108 | 65 | Fawn         | ..... | \$ 229.00 | pr. |



### Front Split Bench

Made from Madrid grain vinyl.

|          |    |              |       |           |     |
|----------|----|--------------|-------|-----------|-----|
| 65-51111 | 65 | Black        | ..... | \$ 299.00 | ea. |
| 65-51112 | 65 | Red          | ..... | \$ 299.00 | ea. |
| 65-51113 | 65 | Light Blue   | ..... | \$ 299.00 | ea. |
| 65-51114 | 65 | Aqua         | ..... | \$ 299.00 | ea. |
| 65-51116 | 65 | Light Saddle | ..... | \$ 299.00 | ea. |
| 65-51118 | 65 | Fawn         | ..... | \$ 299.00 | ea. |

### Rear Bench, 2-Door Hardtop

Made from Madrid grain vinyl.

|          |    |              |       |           |     |
|----------|----|--------------|-------|-----------|-----|
| 65-51121 | 65 | Black        | ..... | \$ 175.00 | ea. |
| 65-51122 | 65 | Red          | ..... | \$ 175.00 | ea. |
| 65-51123 | 65 | Light Blue   | ..... | \$ 175.00 | ea. |
| 65-51124 | 65 | Aqua         | ..... | \$ 175.00 | ea. |
| 65-51125 | 65 | Light Saddle | ..... | \$ 175.00 | ea. |
| 65-51126 | 65 | Fawn         | ..... | \$ 175.00 | ea. |

### Rear Bench, 2-Door Sedan

Made from Madrid grain vinyl.

|          |    |              |       |           |     |
|----------|----|--------------|-------|-----------|-----|
| 65-51131 | 65 | Black        | ..... | \$ 209.00 | ea. |
| 65-51132 | 65 | Red          | ..... | \$ 209.00 | ea. |
| 65-51133 | 65 | Light Blue   | ..... | \$ 209.00 | ea. |
| 65-51134 | 65 | Aqua         | ..... | \$ 209.00 | ea. |
| 65-51135 | 65 | Light Saddle | ..... | \$ 209.00 | ea. |
| 65-51136 | 65 | Fawn         | ..... | \$ 209.00 | ea. |

## 1965 4-DOOR SEDAN OR WAGON SEAT UPHOLSTERY



### Front Straight Bench

Made from Madrid grain vinyl. Features SS style insert.

|          |    |            |       |           |     |
|----------|----|------------|-------|-----------|-----|
| 65-51141 | 65 | Black      | ..... | \$ 299.00 | ea. |
| 65-51142 | 65 | Red        | ..... | \$ 299.00 | ea. |
| 65-51143 | 65 | Light Blue | ..... | \$ 299.00 | ea. |
| 65-51144 | 65 | Aqua       | ..... | \$ 299.00 | ea. |
| 65-51146 | 65 | Saddle     | ..... | \$ 299.00 | ea. |
| 65-51149 | 65 | Fawn       | ..... | \$ 299.00 | ea. |



### Rear Bench, 4-Door Sedan

Made from Madrid grain vinyl. Features SS style insert.

|          |    |            |       |           |     |
|----------|----|------------|-------|-----------|-----|
| 65-51161 | 65 | Black      | ..... | \$ 269.00 | ea. |
| 65-51162 | 65 | Red        | ..... | \$ 269.00 | ea. |
| 65-51163 | 65 | Light Blue | ..... | \$ 269.00 | ea. |
| 65-51164 | 65 | Aqua       | ..... | \$ 269.00 | ea. |
| 65-51166 | 65 | Saddle     | ..... | \$ 269.00 | ea. |
| 65-51168 | 65 | Fawn       | ..... | \$ 269.00 | ea. |

### Rear Bench, 4-Door Station Wagon

Made from Madrid grain vinyl. Features SS style insert.

|          |    |            |       |           |     |
|----------|----|------------|-------|-----------|-----|
| 65-51171 | 65 | Black      | ..... | \$ 269.00 | ea. |
| 65-51172 | 65 | Red        | ..... | \$ 269.00 | ea. |
| 65-51173 | 65 | Light Blue | ..... | \$ 269.00 | ea. |
| 65-51174 | 65 | Aqua       | ..... | \$ 269.00 | ea. |
| 65-51176 | 65 | Saddle     | ..... | \$ 269.00 | ea. |
| 65-51178 | 65 | Fawn       | ..... | \$ 269.00 | ea. |



✦ The following items require additional shipping and handling.

Fax Order 1-714-771-0407 • Toll Free 1-800-235-2470 • [www.TruckandCarShop.com](http://www.TruckandCarShop.com) • 2014 Catalog



# CHEVROLET NOVA PARTS

Car Shop Inc. 739 North Batavia Orange, California 92868

## 1966 CHEVY II/NOVA SS SEAT UPHOLSTERY



**CAR SHOP OFFERS  
THE HIGHEST QUALITY UPHOLSTERY!**  
• BEST FIT! • BEST QUALITY! • BEST PRICE! •



### Front Buckets

Made from Madrid grain vinyl. Features SS style insert.

|          |    |             |       |           |     |
|----------|----|-------------|-------|-----------|-----|
| 66-51181 | 66 | Black       | ..... | \$ 229.00 | pr. |
| 66-51182 | 66 | Red         | ..... | \$ 229.00 | pr. |
| 66-51183 | 66 | Light Blue  | ..... | \$ 229.00 | pr. |
| 66-51184 | 66 | Bright Blue | ..... | \$ 229.00 | pr. |
| 66-51185 | 66 | Turquoise   | ..... | \$ 229.00 | pr. |
| 66-51186 | 66 | Fawn        | ..... | \$ 229.00 | pr. |



### Front Split Bench

Made from Madrid grain vinyl. Features SS style insert.

|          |    |             |       |           |     |
|----------|----|-------------|-------|-----------|-----|
| 66-51191 | 66 | Black       | ..... | \$ 299.00 | ea. |
| 66-51192 | 66 | Red         | ..... | \$ 299.00 | ea. |
| 66-51193 | 66 | Light Blue  | ..... | \$ 299.00 | ea. |
| 66-51194 | 66 | Bright Blue | ..... | \$ 299.00 | ea. |
| 66-51195 | 66 | Turquoise   | ..... | \$ 299.00 | ea. |
| 66-51196 | 66 | Fawn        | ..... | \$ 299.00 | ea. |

• **CAR SHOP • BEST QUALITY! •**  
• **BEST PRICE! •**

## 1966 CHEVY II/NOVA SS SEAT UPHOLSTERY



### Rear Bench, 2-Door Hardtop

Made from Madrid grain vinyl. Features SS style insert.

|          |    |             |       |           |     |
|----------|----|-------------|-------|-----------|-----|
| 66-51201 | 66 | Black       | ..... | \$ 155.00 | ea. |
| 66-51202 | 66 | Red         | ..... | \$ 155.00 | ea. |
| 66-51203 | 66 | Light Blue  | ..... | \$ 155.00 | ea. |
| 66-51204 | 66 | Bright Blue | ..... | \$ 155.00 | ea. |
| 66-51205 | 66 | Aqua        | ..... | \$ 155.00 | ea. |
| 66-51206 | 66 | Fawn        | ..... | \$ 155.00 | ea. |

### Rear Bench, 2-Door Sedan

Made from Madrid grain vinyl. Features SS style insert.

|          |    |             |       |           |     |
|----------|----|-------------|-------|-----------|-----|
| 66-51211 | 66 | Black       | ..... | \$ 209.00 | ea. |
| 66-51212 | 66 | Red         | ..... | \$ 209.00 | ea. |
| 66-51213 | 66 | Light Blue  | ..... | \$ 209.00 | ea. |
| 66-51214 | 66 | Bright Blue | ..... | \$ 209.00 | ea. |
| 66-51215 | 66 | Aqua        | ..... | \$ 209.00 | ea. |
| 66-51216 | 66 | Fawn        | ..... | \$ 209.00 | ea. |

## 1966 2-DOOR SEAT UPHOLSTERY



### Front Split Bench

Madrid grain vinyl. Features "Fish-scale" textured vinyl inserts.

|          |    |            |       |           |     |
|----------|----|------------|-------|-----------|-----|
| 66-51221 | 66 | Black      | ..... | \$ 269.00 | ea. |
| 66-51222 | 66 | Red        | ..... | \$ 269.00 | ea. |
| 66-51223 | 66 | Light Blue | ..... | \$ 269.00 | ea. |
| 66-51224 | 66 | Aqua       | ..... | \$ 269.00 | ea. |
| 66-51225 | 66 | Fawn       | ..... | \$ 269.00 | ea. |

## 1966 2-DOOR SEAT UPHOLSTERY

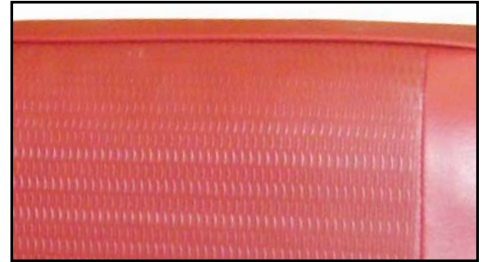

### Rear Bench, 2-Door Hardtop

Madrid grain vinyl. Features "Fish-scale" textured vinyl inserts.

|          |    |            |       |           |     |
|----------|----|------------|-------|-----------|-----|
| 66-51231 | 66 | Black      | ..... | \$ 209.00 | ea. |
| 66-51232 | 66 | Red        | ..... | \$ 209.00 | ea. |
| 66-51233 | 66 | Light Blue | ..... | \$ 209.00 | ea. |
| 66-51234 | 66 | Aqua       | ..... | \$ 209.00 | ea. |
| 66-51235 | 66 | Fawn       | ..... | \$ 209.00 | ea. |

### Rear Bench, 2-Door Sedan

Madrid grain vinyl. Features "Fish-scale" textured vinyl inserts.

|          |    |            |       |           |     |
|----------|----|------------|-------|-----------|-----|
| 66-51241 | 66 | Black      | ..... | \$ 209.00 | ea. |
| 66-51242 | 66 | Red        | ..... | \$ 209.00 | ea. |
| 66-51243 | 66 | Light Blue | ..... | \$ 209.00 | ea. |
| 66-51244 | 66 | Aqua       | ..... | \$ 209.00 | ea. |
| 66-51245 | 66 | Fawn       | ..... | \$ 209.00 | ea. |

## 1966 4-DOOR SEDAN OR WAGON SEAT UPHOLSTERY



### Front Straight Bench

Made from Madrid grain vinyl. Features SS style insert.

|          |    |            |       |           |     |
|----------|----|------------|-------|-----------|-----|
| 66-51251 | 66 | Black      | ..... | \$ 299.00 | ea. |
| 66-51252 | 66 | Red        | ..... | \$ 299.00 | ea. |
| 66-51253 | 66 | Light Blue | ..... | \$ 299.00 | ea. |
| 66-51254 | 66 | Aqua       | ..... | \$ 299.00 | ea. |
| 66-51258 | 66 | Fawn       | ..... | \$ 299.00 | ea. |

### Rear Bench, 4-Door Sedan

Made from Madrid grain vinyl. Features SS style insert.

|          |    |            |       |           |     |
|----------|----|------------|-------|-----------|-----|
| 66-51261 | 66 | Black      | ..... | \$ 269.00 | ea. |
| 66-51262 | 66 | Red        | ..... | \$ 269.00 | ea. |
| 66-51263 | 66 | Light Blue | ..... | \$ 269.00 | ea. |
| 66-51264 | 66 | Aqua       | ..... | \$ 269.00 | ea. |
| 66-51268 | 66 | Fawn       | ..... | \$ 269.00 | ea. |

### Rear Bench, 4-Door Station Wagon

Made from Madrid grain vinyl. Features SS style insert.

|          |    |            |       |           |     |
|----------|----|------------|-------|-----------|-----|
| 66-51271 | 66 | Black      | ..... | \$ 269.00 | ea. |
| 66-51272 | 66 | Red        | ..... | \$ 269.00 | ea. |
| 66-51273 | 66 | Light Blue | ..... | \$ 269.00 | ea. |
| 66-51274 | 66 | Aqua       | ..... | \$ 269.00 | ea. |
| 66-51278 | 66 | Fawn       | ..... | \$ 269.00 | ea. |

✦ The following items require additional shipping and handling.

# CHEVROLET NOVA PARTS



Car Shop Inc. 739 North Batavia Orange, California 92868

## 1967 CHEVY II/NOVA SS SEAT UPHOLSTERY



### Front Buckets

Made from Madrid grain vinyl. Features SS style white vertical stripe.

|          |    |             |       |           |     |
|----------|----|-------------|-------|-----------|-----|
| 67-51281 | 67 | Black       | ..... | \$ 229.00 | pr. |
| 67-51282 | 67 | Red         | ..... | \$ 229.00 | pr. |
| 67-51284 | 67 | Bright Blue | ..... | \$ 229.00 | pr. |
| 67-51285 | 67 | Gold        | ..... | \$ 229.00 | pr. |



### Rear Bench, 2-Door Hardtop

Made from Madrid grain vinyl. Features SS style white vertical stripe.

|          |    |             |       |           |     |
|----------|----|-------------|-------|-----------|-----|
| 67-51291 | 67 | Black       | ..... | \$ 155.00 | ea. |
| 67-51292 | 67 | Red         | ..... | \$ 155.00 | ea. |
| 67-51294 | 67 | Bright Blue | ..... | \$ 155.00 | ea. |
| 67-51295 | 67 | Gold        | ..... | \$ 155.00 | ea. |

## 1967 CHEVY II/NOVA SEAT UPHOLSTERY



### Front Split Bench

Made from Madrid grain vinyl.

Features SS style pattern with matching color vertical stripe.

|          |    |             |       |           |     |
|----------|----|-------------|-------|-----------|-----|
| 67-51301 | 67 | Black       | ..... | \$ 299.00 | ea. |
| 67-51302 | 67 | Red         | ..... | \$ 299.00 | ea. |
| 67-51303 | 67 | Light Blue  | ..... | \$ 299.00 | ea. |
| 67-51304 | 67 | Bright Blue | ..... | \$ 299.00 | ea. |
| 67-51305 | 67 | Gold        | ..... | \$ 299.00 | ea. |
| 67-51306 | 67 | Ivy Gold    | ..... | \$ 299.00 | ea. |



### Rear Bench, 2-Door Hardtop

Features SS style pattern with matching color vertical stripe.

|          |    |             |       |           |     |
|----------|----|-------------|-------|-----------|-----|
| 67-51311 | 67 | Black       | ..... | \$ 155.00 | ea. |
| 67-51312 | 67 | Red         | ..... | \$ 155.00 | ea. |
| 67-51313 | 67 | Light Blue  | ..... | \$ 155.00 | ea. |
| 67-51314 | 67 | Bright Blue | ..... | \$ 155.00 | ea. |
| 67-51315 | 67 | Gold        | ..... | \$ 155.00 | ea. |
| 67-51316 | 67 | Ivy Gold    | ..... | \$ 155.00 | ea. |

### Rear Bench, 2-Door Sedan

Features SS style pattern with matching color vertical stripe.

|          |    |             |       |           |     |
|----------|----|-------------|-------|-----------|-----|
| 67-51321 | 67 | Black       | ..... | \$ 209.00 | ea. |
| 67-51322 | 67 | Red         | ..... | \$ 209.00 | ea. |
| 67-51323 | 67 | Light Blue  | ..... | \$ 209.00 | ea. |
| 67-51324 | 67 | Bright Blue | ..... | \$ 209.00 | ea. |
| 67-51325 | 67 | Gold        | ..... | \$ 209.00 | ea. |
| 67-51326 | 67 | Ivy Gold    | ..... | \$ 209.00 | ea. |

## 1967 2-DOOR SEAT UPHOLSTERY



### Front Split Bench

Madrid grain vinyl. Features "Fish-scale" textured vinyl inserts.

|          |    |            |       |           |     |
|----------|----|------------|-------|-----------|-----|
| 67-51331 | 67 | Black      | ..... | \$ 299.00 | ea. |
| 67-51332 | 67 | Red        | ..... | \$ 299.00 | ea. |
| 67-51333 | 67 | Light Blue | ..... | \$ 299.00 | ea. |
| 67-51334 | 67 | Ivy Gold   | ..... | \$ 299.00 | ea. |

### Rear Bench, 2-Door Hardtop

Madrid grain vinyl. Features "Fish-scale" textured vinyl inserts.

|          |    |            |       |           |     |
|----------|----|------------|-------|-----------|-----|
| 67-51341 | 67 | Black      | ..... | \$ 209.00 | ea. |
| 67-51342 | 67 | Red        | ..... | \$ 209.00 | ea. |
| 67-51343 | 67 | Light Blue | ..... | \$ 209.00 | ea. |
| 67-51344 | 67 | Ivy Gold   | ..... | \$ 209.00 | ea. |

### Rear Bench, 2-Door Sedan

Madrid grain vinyl. Features "Fish-scale" textured vinyl inserts.

|          |    |            |       |           |     |
|----------|----|------------|-------|-----------|-----|
| 67-51351 | 67 | Black      | ..... | \$ 209.00 | ea. |
| 67-51352 | 67 | Red        | ..... | \$ 209.00 | ea. |
| 67-51353 | 67 | Light Blue | ..... | \$ 209.00 | ea. |
| 67-51354 | 67 | Ivy Gold   | ..... | \$ 209.00 | ea. |

## 1967 4-DOOR SEDAN OR WAGON SEAT UPHOLSTERY



### Front Straight Bench

Made from Madrid grain vinyl.

Features SS style pattern with matching color vertical stripe.

|          |    |            |       |           |     |
|----------|----|------------|-------|-----------|-----|
| 67-51361 | 67 | Black      | ..... | \$ 299.00 | ea. |
| 67-51363 | 67 | Light Blue | ..... | \$ 299.00 | ea. |
| 67-51364 | 67 | Ivy Gold   | ..... | \$ 299.00 | ea. |

### Rear Bench, 4-Door Sedan

Features SS style pattern with matching color vertical stripe.

|          |    |            |       |           |     |
|----------|----|------------|-------|-----------|-----|
| 67-51371 | 67 | Black      | ..... | \$ 269.00 | ea. |
| 67-51373 | 67 | Light Blue | ..... | \$ 269.00 | ea. |
| 67-51374 | 67 | Ivy Gold   | ..... | \$ 269.00 | ea. |

### Rear Bench, 4-Door Station Wagon

Features SS style pattern with matching color vertical stripe.

|          |    |            |       |           |     |
|----------|----|------------|-------|-----------|-----|
| 67-51381 | 67 | Black      | ..... | \$ 269.00 | ea. |
| 67-51383 | 67 | Light Blue | ..... | \$ 269.00 | ea. |
| 67-51384 | 67 | Ivy Gold   | ..... | \$ 269.00 | ea. |



† The following items require additional shipping and handling.

Fax Order 1-714-771-0407 • Toll Free 1-800-235-2470 • [www.TruckandCarShop.com](http://www.TruckandCarShop.com) • 2014 Catalog



# CHEVROLET NOVA PARTS

Car Shop Inc. 739 North Batavia Orange, California 92868

## 1968 CHEVY II/NOVA SS 2-DOOR SEAT UPHOLSTERY



### Front Buckets

Made from Madrid grain vinyl. Sewn inserts with vertical pleats. Emblem buttons not included.

|          |    |          |           |     |
|----------|----|----------|-----------|-----|
| 68-51391 | 68 | Black    | \$ 229.00 | pr. |
| 68-51393 | 68 | Blue     | \$ 229.00 | pr. |
| 68-51394 | 68 | Ivy Gold | \$ 229.00 | pr. |



### Front Split Bench

Made from Madrid grain vinyl. Sewn inserts with vertical pleats.

|          |    |          |           |     |
|----------|----|----------|-----------|-----|
| 68-51401 | 68 | Black    | \$ 269.00 | ea. |
| 68-51403 | 68 | Blue     | \$ 269.00 | ea. |
| 68-51404 | 68 | Ivy Gold | \$ 269.00 | ea. |



### Rear Bench, 2-Door Sedan

Made from Madrid grain vinyl. Sewn inserts with vertical pleats.

|          |    |          |           |     |
|----------|----|----------|-----------|-----|
| 68-51411 | 68 | Black    | \$ 155.00 | ea. |
| 68-51413 | 68 | Blue     | \$ 155.00 | ea. |
| 68-51414 | 68 | Ivy Gold | \$ 155.00 | ea. |

## 1968 CHEVY II/NOVA STANDARD 2-DOOR SEAT UPHOLSTERY



### Front Split Bench

Made from Madrid grain vinyl. Sewn inserts with vertical pleats.

|          |    |          |           |     |
|----------|----|----------|-----------|-----|
| 68-51421 | 68 | Black    | \$ 235.00 | ea. |
| 68-51423 | 68 | Blue     | \$ 235.00 | ea. |
| 68-51424 | 68 | Ivy Gold | \$ 235.00 | ea. |

### Rear Bench, 2-Door Sedan

Made from Madrid grain vinyl. Sewn inserts with vertical pleats.

|          |    |          |           |     |
|----------|----|----------|-----------|-----|
| 68-51426 | 68 | Black    | \$ 155.00 | ea. |
| 68-51427 | 68 | Blue     | \$ 155.00 | ea. |
| 68-51428 | 68 | Ivy Gold | \$ 155.00 | ea. |



## 1969-71 CHEVY II/NOVA SS/CUSTOM 2-DOOR SEAT UPHOLSTERY



### Front Buckets

Made from Madrid grain vinyl, with basketweave design center strip.

|          |       |                     |           |     |
|----------|-------|---------------------|-----------|-----|
| 69-51431 | 69-71 | Black               | \$ 229.00 | pr. |
| 69-51432 | 69    | Red                 | \$ 229.00 | pr. |
| 69-51433 | 69    | Bright Blue         | \$ 229.00 | pr. |
| 69-51434 | 69    | Light Green         | \$ 229.00 | pr. |
| 69-51435 | 69-70 | Light Blue          | \$ 229.00 | pr. |
| 69-51436 | 69-70 | Dark Metallic Green | \$ 229.00 | pr. |
| 70-51437 | 70    | Gold                | \$ 229.00 | pr. |
| 70-51438 | 70    | Light Saddle        | \$ 229.00 | pr. |
| 70-51439 | 70-71 | Sandalwood          | \$ 229.00 | pr. |
| 71-51440 | 71    | Dark Blue           | \$ 229.00 | pr. |
| 71-51441 | 71    | Jade Green          | \$ 229.00 | pr. |
| 71-51442 | 71    | Dark Saddle         | \$ 229.00 | pr. |

## 1969-71 CHEVY II/NOVA SS/CUSTOM 2-DOOR SEAT UPHOLSTERY



### Front Split Bench

Made from Madrid grain vinyl, with basketweave design center strip.

|          |       |                     |           |     |
|----------|-------|---------------------|-----------|-----|
| 69-51451 | 69-71 | Black               | \$ 229.00 | ea. |
| 69-51452 | 69    | Red                 | \$ 229.00 | ea. |
| 69-51453 | 69    | Bright Blue         | \$ 229.00 | ea. |
| 69-51454 | 69    | Light Green         | \$ 229.00 | ea. |
| 69-51455 | 69-70 | Light Blue          | \$ 229.00 | ea. |
| 69-51456 | 69-70 | Dark Metallic Green | \$ 229.00 | ea. |
| 70-51457 | 70    | Gold                | \$ 229.00 | ea. |
| 70-51458 | 70    | Light Saddle        | \$ 229.00 | ea. |
| 70-51459 | 70-71 | Sandalwood          | \$ 229.00 | ea. |
| 71-51460 | 71    | Dark Blue           | \$ 229.00 | ea. |
| 71-51461 | 71    | Jade Green          | \$ 229.00 | ea. |
| 71-51462 | 71    | Dark Saddle         | \$ 229.00 | ea. |



### Rear Bench, 2-Door Sedan

Made from Madrid grain vinyl, with basketweave design center strip.

|          |       |                     |           |     |
|----------|-------|---------------------|-----------|-----|
| 69-51471 | 69-71 | Black               | \$ 155.00 | ea. |
| 69-51472 | 69    | Red                 | \$ 155.00 | ea. |
| 69-51473 | 69    | Bright Blue         | \$ 155.00 | ea. |
| 69-51474 | 69    | Light Green         | \$ 155.00 | ea. |
| 69-51475 | 69-70 | Light Blue          | \$ 155.00 | ea. |
| 69-51476 | 69-70 | Dark Metallic Green | \$ 155.00 | ea. |
| 70-51477 | 70    | Gold                | \$ 155.00 | ea. |
| 70-51478 | 70    | Light Saddle        | \$ 155.00 | ea. |
| 70-51479 | 70-71 | Sandalwood          | \$ 155.00 | ea. |
| 71-51480 | 71    | Dark Blue           | \$ 155.00 | ea. |
| 71-51481 | 71    | Jade Green          | \$ 155.00 | ea. |
| 71-51482 | 71    | Dark Saddle         | \$ 155.00 | ea. |

\* The following items require additional shipping and handling.



# CHEVROLET NOVA PARTS



Car Shop Inc. 739 North Batavia Orange, California 92868

## 1972 NOVA 2-DOOR SEAT UPHOLSTERY



### Front High-back Buckets

Made from Madrid grain vinyl with Pigskin grain vinyl inserts, with basketweave design center strip.

|          |    |            |       |           |     |
|----------|----|------------|-------|-----------|-----|
| 72-51501 | 72 | Black      | ..... | \$ 299.00 | pr. |
| 72-51502 | 72 | Tan        | ..... | \$ 299.00 | pr. |
| 72-51503 | 72 | Covert     | ..... | \$ 299.00 | pr. |
| 72-51504 | 72 | Dark Green | ..... | \$ 299.00 | pr. |

### Front Split Bench

Made from Madrid grain vinyl with Pigskin grain vinyl inserts, with basketweave design center strip.

|          |    |            |       |           |     |
|----------|----|------------|-------|-----------|-----|
| 72-51511 | 72 | Black      | ..... | \$ 299.00 | ea. |
| 72-51512 | 72 | Tan        | ..... | \$ 299.00 | ea. |
| 72-51513 | 72 | Covert     | ..... | \$ 299.00 | ea. |
| 72-51514 | 72 | Dark Green | ..... | \$ 299.00 | ea. |

### Rear Bench, 2-Door Sedan

Made from Madrid grain vinyl with Pigskin grain vinyl inserts, with basketweave design center strip.

|          |    |            |       |           |     |
|----------|----|------------|-------|-----------|-----|
| 72-51521 | 72 | Black      | ..... | \$ 155.00 | ea. |
| 72-51522 | 72 | Tan        | ..... | \$ 155.00 | ea. |
| 72-51523 | 72 | Covert     | ..... | \$ 155.00 | ea. |
| 72-51524 | 72 | Dark Green | ..... | \$ 155.00 | ea. |

## 1969-72 4-DOOR SEDAN SEAT UPHOLSTERY



### Front Straight Bench

Made from Madrid grain vinyl.

Features SS style pattern with basketweave design center strip.

|          |       |                     |       |           |     |
|----------|-------|---------------------|-------|-----------|-----|
| 69-51531 | 69-72 | Black               | ..... | \$ 299.00 | ea. |
| 69-51532 | 69-70 | Light Blue          | ..... | \$ 299.00 | ea. |
| 69-51533 | 69-70 | Gold                | ..... | \$ 299.00 | ea. |
| 69-51534 | 69-70 | Dark Metallic Green | ..... | \$ 299.00 | ea. |
| 71-51535 | 71    | Jade Green          | ..... | \$ 299.00 | ea. |
| 71-51536 | 71-72 | Dark Blue           | ..... | \$ 299.00 | ea. |
| 71-51537 | 71-72 | Sandalwood          | ..... | \$ 299.00 | ea. |
| 72-51538 | 72    | Dark Green          | ..... | \$ 299.00 | ea. |

### Rear Bench, 4-Door Sedan

Features SS style pattern with basketweave design center strip.

|          |       |                     |       |           |     |
|----------|-------|---------------------|-------|-----------|-----|
| 69-51541 | 69-72 | Black               | ..... | \$ 269.00 | ea. |
| 69-51542 | 69-70 | Light Blue          | ..... | \$ 269.00 | ea. |
| 69-51543 | 69-70 | Gold                | ..... | \$ 269.00 | ea. |
| 69-51544 | 69-70 | Dark Metallic Green | ..... | \$ 269.00 | ea. |
| 71-51545 | 71    | Jade Green          | ..... | \$ 269.00 | ea. |
| 71-51546 | 71-72 | Dark Blue           | ..... | \$ 269.00 | ea. |
| 71-51547 | 71-72 | Sandalwood          | ..... | \$ 269.00 | ea. |
| 72-51548 | 72    | Dark Green          | ..... | \$ 269.00 | ea. |

## 1973-74 NOVA CUSTOM 2-DOOR SEAT UPHOLSTERY



### Front High-back Buckets

Made from Madrid grain vinyl with Tetra grain vinyl inserts, with matching vinyl covered buttons.

|          |       |            |       |           |     |
|----------|-------|------------|-------|-----------|-----|
| 73-51551 | 73-74 | Black      | ..... | \$ 299.00 | pr. |
| 73-51552 | 73-74 | White      | ..... | \$ 299.00 | pr. |
| 73-51553 | 73-74 | Sandalwood | ..... | \$ 299.00 | pr. |



### Front Bench

Made from Madrid grain vinyl with Tetra grain vinyl inserts, with matching vinyl covered buttons.

|          |       |            |       |           |     |
|----------|-------|------------|-------|-----------|-----|
| 73-51555 | 73-74 | Black      | ..... | \$ 355.00 | ea. |
| 73-51556 | 73-74 | White      | ..... | \$ 355.00 | ea. |
| 73-51557 | 73-74 | Sandalwood | ..... | \$ 355.00 | ea. |

### Rear Bench, 2-Door Sedan

Made from Madrid grain vinyl with Tetra grain vinyl inserts, with matching vinyl covered buttons.

|          |       |            |       |           |     |
|----------|-------|------------|-------|-----------|-----|
| 73-51561 | 73-74 | Black      | ..... | \$ 175.00 | ea. |
| 73-51562 | 73-74 | White      | ..... | \$ 175.00 | ea. |
| 73-51563 | 73-74 | Sandalwood | ..... | \$ 175.00 | ea. |

### Rear Bench, 2-Door Hatchback

Made from Madrid grain vinyl with Tetra grain vinyl inserts, with matching vinyl covered buttons.

|          |       |            |       |           |     |
|----------|-------|------------|-------|-----------|-----|
| 73-51565 | 73-74 | Black      | ..... | \$ 175.00 | ea. |
| 73-51566 | 73-74 | White      | ..... | \$ 175.00 | ea. |
| 73-51567 | 73-74 | Sandalwood | ..... | \$ 175.00 | ea. |



## SEAT UPHOLSTERY INSTALLATION KIT



Comes complete with a set of hog ring pliers and enough hog rings to install 1 complete set of seat upholstery.

|          |       |                  |       |         |     |
|----------|-------|------------------|-------|---------|-----|
| 67-01307 | 62-79 | Installation Kit | ..... | \$ 9.00 | kit |
|----------|-------|------------------|-------|---------|-----|

† The following items require additional shipping and handling.

Fax Order 1-714-771-0407 • Toll Free 1-800-235-2470 • [www.TruckandCarShop.com](http://www.TruckandCarShop.com) • 2014 Catalog



# CHEVROLET NOVA PARTS

Car Shop Inc. 739 North Batavia Orange, California 92868

## BUCKET SEAT FRAME ASSEMBLY

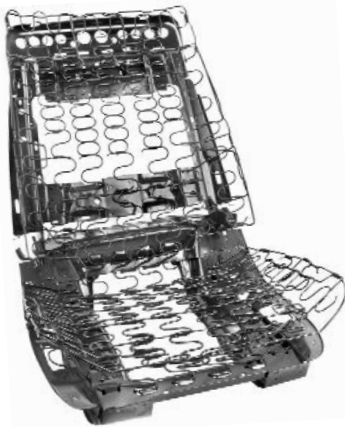

Includes: seat frame, seat springs, seat tracks and chrome knobs.  
**69-00930+** 69-71 LH or RH .....\$ 389.00 ea.

## REAR SEAT BOLTS



1/4-14 x 7/8, with 1" O.D. toothed washer.  
**67-013078** 2 pieces .....\$ 3.50 pr.

## REAR SEAT FRAME TO FLOOR RETAINER



Universal, original for 1967-1969 Camaro.  
**67-013079** retainer .....\$ 6.00 ea.

## BUCKET SEAT SUPPORT SPRINGS



"Seat back" spring assembly  
**66-01000+** 64-65 .....\$ 105.00 ea.  
**66-01001+** 66-67 .....\$ 105.00 ea.  
**68-01002+** 68-71 .....\$ 105.00 ea.

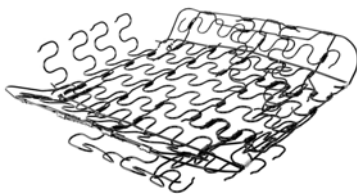

"Seat bottom" with side support springs  
**64-01003+** 64-65 .....\$ 105.00 ea.  
**66-01004+** 66-67 .....\$ 105.00 ea.  
**68-01005+** 68-71 .....\$ 105.00 ea.

## SEAT FOAM



**BUCKET SEAT FOAM**  
**64-01017+** 62-65 .....\$ 89.00 ea.  
**66-01018+** 66 all .....\$ 89.00 ea.  
 67 exc SS  
 68-71 all .....\$ 89.00 ea.



**71-01407+** 72-79 .....\$ 130.00 ea.

## FRONT SPLIT BENCH SEAT FOAM



**71-01021+** 71-72 Front, 2-door .....\$ 229.00 ea.

**Showroom hours:**  
**TUESDAY - FRIDAY: 8:30AM to 4:30PM**  
**SATURDAY: 8:30AM to 3:30PM**  
**Phone order desk hours:**  
**MONDAY - FRIDAY: 8:30AM to 4:30PM**  
[www.TruckandCarShop.com](http://www.TruckandCarShop.com)

## PLASTIC BUCKET SEAT BACKS (WITH CHROME TRIM)



Chrome trim & Bullets installed  
**66-00932** 66 Black, plastic .....\$ 65.00 pr.  
**66-00933** 66 Red .....\$ 85.00 pr.  
**66-00934** 66 White .....\$ 85.00 pr.  
**66-00935** 66 Aqua .....\$ 85.00 pr.  
**66-00936** 66 Lt. Blue .....\$ 85.00 pr.  
**66-00937** 66 Dk. Blue .....\$ 85.00 pr.



Chrome trim & Bullets installed  
**67-00932** 67-68 Black .....\$ 65.00 pr.  
**67-00933** 67-68 Red .....\$ 85.00 pr.  
**68-00934** 68 Pearl .....\$ 85.00 pr.  
**67-00935** 67-68 Lt. Blue .....\$ 85.00 pr.  
**68-00936** 68 Med. Blue .....\$ 85.00 pr.

Chrome trim installed



**69-00937** 69-71 Black .....\$ 65.00 pr.  
**69-00938** 69-71 Red .....\$ 85.00 pr.  
**69-00939** 69-71 Dk. Blue .....\$ 85.00 pr.  
**69-00940** 69-71 Brt. Blue .....\$ 85.00 pr.  
**69-00941** 69-71 Parchment .....\$ 85.00 pr.  
**69-00942** 69-71 Dk. Green .....\$ 85.00 pr.  
**69-00943** 69-71 Lt. Saddle .....\$ 85.00 pr.  
**69-00944** 69-71 Dk. Saddle .....\$ 85.00 pr.  
**69-00945** 69-71 Sandalwood .....\$ 85.00 pr.  
**69-00946** 69-71 White .....\$ 85.00 pr.  
**69-00947** 69-71 Pearl .....\$ 85.00 pr.

+ The following items require additional shipping and handling.

# CHEVROLET NOVA PARTS



Car Shop Inc. 739 North Batavia Orange, California 92868

## BUCKET SEAT LOWER SIDE PANELS (WITH CHROME TRIM)

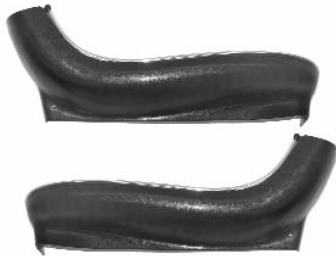

|          |       |            |       |          |     |
|----------|-------|------------|-------|----------|-----|
| 66-00948 | 66-67 | Black      | ..... | \$ 55.00 | pr. |
| 66-00949 | 66-67 | Red        | ..... | \$ 69.00 | pr. |
| 66-00950 | 66-67 | White      | ..... | \$ 69.00 | pr. |
| 66-00951 | 66-67 | Aqua       | ..... | \$ 69.00 | pr. |
| 66-00952 | 66-67 | Lt. Blue   | ..... | \$ 69.00 | pr. |
| 66-00953 | 66-67 | Dk. Blue   | ..... | \$ 69.00 | pr. |
| 68-00948 | 68    | Black      | ..... | \$ 55.00 | pr. |
| 68-00949 | 68    | Red        | ..... | \$ 69.00 | pr. |
| 68-00950 | 68    | Pearl      | ..... | \$ 69.00 | pr. |
| 68-00951 | 68    | Lt. Blue   | ..... | \$ 69.00 | pr. |
| 68-00952 | 68    | Med. Blue  | ..... | \$ 69.00 | pr. |
| 69-00953 | 69-71 | Black      | ..... | \$ 55.00 | pr. |
| 69-00954 | 69-71 | Red        | ..... | \$ 69.00 | pr. |
| 69-00955 | 69-71 | Dk. Blue   | ..... | \$ 69.00 | pr. |
| 69-00956 | 69-71 | Brt. Blue  | ..... | \$ 69.00 | pr. |
| 69-00957 | 69-71 | Parchment  | ..... | \$ 69.00 | pr. |
| 69-00958 | 69-71 | Dk. Green  | ..... | \$ 69.00 | pr. |
| 69-00959 | 69-71 | Lt. Saddle | ..... | \$ 69.00 | pr. |
| 69-00960 | 69-71 | Dk. Saddle | ..... | \$ 69.00 | pr. |
| 69-00961 | 69-71 | Sandalwood | ..... | \$ 69.00 | pr. |
| 69-00962 | 69-71 | White      | ..... | \$ 69.00 | pr. |
| 69-00963 | 69-71 | Pearl      | ..... | \$ 69.00 | pr. |

## BUCKET SEAT BACK & SIDE PANEL KIT

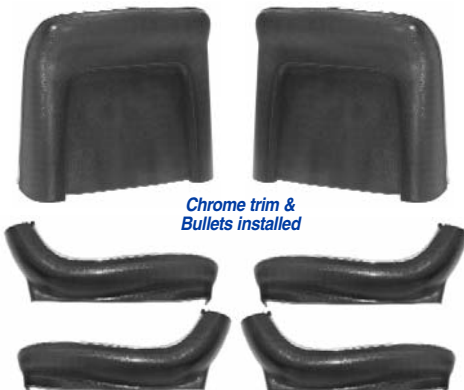

|           |    |          |       |           |     |
|-----------|----|----------|-------|-----------|-----|
| 66-009482 | 66 | Black    | ..... | \$ 159.00 | kit |
| 66-009492 | 66 | Red      | ..... | \$ 189.00 | kit |
| 66-009502 | 66 | White    | ..... | \$ 189.00 | kit |
| 66-009512 | 66 | Aqua     | ..... | \$ 189.00 | kit |
| 66-009522 | 66 | Lt. Blue | ..... | \$ 189.00 | kit |
| 66-009532 | 66 | Dk. Blue | ..... | \$ 189.00 | kit |
| 67-009482 | 67 | Black    | ..... | \$ 159.00 | kit |
| 67-009492 | 67 | Red      | ..... | \$ 189.00 | kit |
| 67-009502 | 67 | White    | ..... | \$ 189.00 | kit |
| 67-009512 | 67 | Aqua     | ..... | \$ 189.00 | kit |
| 67-009522 | 67 | Lt. Blue | ..... | \$ 189.00 | kit |
| 67-009532 | 67 | Dk. Blue | ..... | \$ 189.00 | kit |

## BUCKET SEAT BACK & SIDE PANEL KIT



1968 correct with bullet ends  
1969-72 correct w/o bullet ends

|           |       |            |       |           |     |
|-----------|-------|------------|-------|-----------|-----|
| 68-009482 | 68    | Black      | ..... | \$ 159.00 | kit |
| 68-009492 | 68    | Red        | ..... | \$ 189.00 | kit |
| 68-009502 | 68    | Pearl      | ..... | \$ 189.00 | kit |
| 68-009512 | 68    | Lt. Blue   | ..... | \$ 189.00 | kit |
| 68-009522 | 68    | Med. Blue  | ..... | \$ 189.00 | kit |
| 69-009532 | 69-71 | Black      | ..... | \$ 159.00 | kit |
| 69-009542 | 69-71 | Red        | ..... | \$ 189.00 | kit |
| 69-009552 | 69-71 | Dk. Blue   | ..... | \$ 189.00 | kit |
| 69-009562 | 69-71 | Brt. Blue  | ..... | \$ 189.00 | kit |
| 69-009572 | 69-71 | Parchment  | ..... | \$ 189.00 | kit |
| 69-009582 | 69-71 | Dk. Green  | ..... | \$ 189.00 | kit |
| 69-009592 | 69-71 | Lt. Saddle | ..... | \$ 189.00 | kit |
| 69-009602 | 69-71 | Dk. Saddle | ..... | \$ 189.00 | kit |
| 69-009612 | 69-71 | Sandalwood | ..... | \$ 189.00 | kit |
| 69-009622 | 69-71 | White      | ..... | \$ 189.00 | kit |
| 69-009632 | 69-71 | Pearl      | ..... | \$ 189.00 | kit |

## SEAT BACK RELEASE BUTTON AND BEZEL



|          |       |       |          |     |
|----------|-------|-------|----------|-----|
| 67-01112 | 67-68 | ..... | \$ 29.00 | ea. |
|----------|-------|-------|----------|-----|

## SEAT BACK RELEASE BUTTON AND BEZEL



|          |       |       |          |     |
|----------|-------|-------|----------|-----|
| 69-01113 | 69-71 | ..... | \$ 20.00 | ea. |
|----------|-------|-------|----------|-----|

## SEAT BACK RELEASE BUTTON ASSEMBLY



|           |       |       |           |     |
|-----------|-------|-------|-----------|-----|
| 69-011132 | 69-71 | ..... | \$ 107.00 | ea. |
|-----------|-------|-------|-----------|-----|

## SEAT TRACKS



Fits bench seats.

|          |       |         |       |           |     |
|----------|-------|---------|-------|-----------|-----|
| 66-01012 | 66-67 | LH & RH | ..... | \$ 122.00 | pr. |
|----------|-------|---------|-------|-----------|-----|



Fits bucket seats, includes LH & RH tracks for one seat.

|          |       |                |       |          |     |
|----------|-------|----------------|-------|----------|-----|
| 68-01012 | 68-71 | drivers seat   | ..... | \$ 97.00 | pr. |
| 68-01013 | 68-71 | passenger seat | ..... | \$ 97.00 | pr. |

## SEAT TRACK NUT



5/16-18, 1/2 hex, with .87 O.D. toothed washer.

|           |       |          |       |         |     |
|-----------|-------|----------|-------|---------|-----|
| 64-010131 | 68-71 | 6 pieces | ..... | \$ 4.50 | set |
|-----------|-------|----------|-------|---------|-----|

## BUCKET SEAT MOUNTING BRACKETS



|          |       |       |          |     |
|----------|-------|-------|----------|-----|
| 65-06399 | 62-65 | ..... | \$ 79.00 | set |
|----------|-------|-------|----------|-----|

## SEAT FRAME SUPPORT BRACKETS



Original style brackets, a must when replacing old rusty floor pans.  
Welds to floor pan.

|          |       |          |       |           |     |
|----------|-------|----------|-------|-----------|-----|
| 66-00926 | 66-67 | 4 pieces | ..... | \$ 119.00 | set |
|----------|-------|----------|-------|-----------|-----|



|          |       |          |       |           |     |
|----------|-------|----------|-------|-----------|-----|
| 68-00926 | 68-71 | 8 pieces | ..... | \$ 108.00 | set |
|----------|-------|----------|-------|-----------|-----|

+ The following items require additional shipping and handling.



# CHEVROLET NOVA PARTS

Car Shop Inc. 739 North Batavia Orange, California 92868

## SEAT BACK CABLE SCREW



1/4-20 x 11/16, .62 O.D., with .2" shoulder.  
66-063991 .....\$ 4.00 pr.

## BUCKET SEAT CHROME TRIM



This is the chrome tubing that runs along the sides of the bucket seats. Includes enough to do two complete seats.  
66-01014 66-71 Bucket seat chrome ...\$ 19.00 set

## BUCKET SEAT CHROME CAPS



This is the small chrome cap that fits on the end of the chrome tubing. Most years use 12 caps.  
66-01015 66-71 .....\$ 1.50 ea.



66-01016 66-71 Set of 12 caps .....\$ 14.00 ea.

## SEAT UPHOLSTERY EMBLEMS



Fits Super Sport seat upholstery, set of 4, with retainers.  
63-01416 63-65 .....\$ 54.00 set



Fits Super Sport seat upholstery, set of 4, with retainers.  
66-01416 66-67 made in USA .....\$ 101.00 set  
66-01417 66-67 import .....\$ 59.00 set

## BUCKET SEAT CHROME CAPS



These caps fit on the bucket seat back pivot located on the seat base.  
62-06341 62-65 .....\$ 8.00 pr.

## SEAT BRACKET HINGE ARM SIDE COVERS



66-01009 66-72 with bench seat  
Black .....\$ 40.00 pr.

## SEAT BRACKET HINGE ARM SIDE COVER RETAINERS



67-01418 66-72 with bench seat .....\$ 3.75 pr.

## SEAT PIVOT E-CLIP KIT



67-01419 66-72 4 pieces .....\$ 3.50 kit

## SEAT TRACK ADJUSTER KNOB



66-06232 65-66 Chrome, made in USA ..\$ 22.00 ea.  
66-062321 65-66 Chrome, import .....\$ 15.00 ea.



67-01422 68-71 Chrome .....\$ 7.50 ea.  
67-01421 68-71 Black .....\$ 3.00 ea.

## RUBBER SEAT BACK BUMPERS



62-06211 62-64 "SS", 4 pcs. with screws \$ 16.00 set



67-01424 62-74 round, with screws ...\$ 5.00 pr.



Oval seat back bumper kit, replacement for some years.  
67-014251 66-74 16 pieces .....\$ 12.00 kit

## 1966-67 HEADREST ASSEMBLY KIT



66-01201 66-67 With bucket seats ....\$ 219.00 kit

## HEADREST ASSEMBLY



66-01202 66-67 With bucket seats ....\$ 164.00 pr.  
69-01203 69 With bucket seats ....\$ 164.00 pr.  
70-01204 70-71 With bucket seats ....\$ 164.00 pr.

## HEADREST COVERS



Top off your upholstery with these pre-sewn vinyl covers.  
Note: Please specify color when ordering.  
68-01205 68-72 Bench seats .....\$ 38.00 pr.  
68-01206 68-71 Bucket seats .....\$ 38.00 pr.

## HEADREST MOUNTING KIT



Kit mounts two headrests.  
66-01207 66-68 .....\$ 62.00 kit

# CHEVROLET NOVA PARTS



Car Shop Inc. 739 North Batavia Orange, California 92868

## HEADREST LOCK ASSEMBLY



- 69-01208 69 with correct round knob .....\$ 35.00 pr.  
 70-01209 70-72 .....\$ 13.00 ea.

## HEADREST ESCUTCHEON & FABRIC RETAINER SCREWS



- 69-012085 69-72 18 pieces .....\$ 5.00 kit

## HEADREST GUIDE SET



- 66-012095 66-68 does one headrest ...\$ 52.00 set

## KICK PANELS



### 1962-64 Hardtop, 2 or 4-Door Sedan or Station Wagon

Colored Panel board, sold in pairs. All models except Convertible.

- 62-01525 62-64 Black .....\$ 20.00 pr.  
 62-01526 62-64 Red .....\$ 20.00 pr.  
 62-01527 62-64 Light Blue .....\$ 20.00 pr.  
 62-01528 62-64 Aqua .....\$ 20.00 pr.  
 62-01529 62-64 Saddle .....\$ 20.00 pr.  
 62-01530 62-64 Fawn .....\$ 20.00 pr.  
 62-01531 62-64 Dark Blue .....\$ 20.00 pr.

### 1962-63 Convertible

Colored Panel board, sold in pairs. Convertible.

- 63-01525 62-63 Black .....\$ 20.00 pr.  
 63-01526 62-63 Red .....\$ 20.00 pr.  
 63-01527 62-63 Light Blue .....\$ 20.00 pr.  
 63-01528 62-63 Aqua .....\$ 20.00 pr.  
 63-01529 62-63 Saddle .....\$ 20.00 pr.  
 63-01530 62-63 Fawn .....\$ 20.00 pr.  
 63-01531 62-63 Dark Blue .....\$ 20.00 pr.

## KICK PANELS



Black only, paint to match.

- 65-01525 65-67 LH .....\$ 100.00 ea.  
 65-01526 65-67 RH .....\$ 100.00 ea.



- 69-01525 69 LH, all  
 70-79 LH, w/o AC .....\$ 108.00 ea.

- 69-01526 69 RH, all  
 70-79 RH, w/o AC .....\$ 108.00 ea.



- 70-01527 70-79 LH, with A/C .....\$ 108.00 ea.  
 70-01528 70-79 RH, with A/C .....\$ 108.00 ea.

## KICK PANELS WITH SPEAKERS



All models are black ABS plastic that can be left as is or painted to match your interior. They come fitted with Custom Auto Sound 60 watt two way speakers or the upgrade Pioneer 120 watt speakers.

- 62-01536 62-63 convertible .....\$ 129.00 pr.  
 62-01537 62-65 coupe .....\$ 129.00 pr.

- Features Pioneer speakers, 120 watts,  
 62-015371 62-63 convertible .....\$ 185.00 pr.  
 62-015372 62-65 coupe .....\$ 185.00 pr.

## KICK PANELS WITH SPEAKERS



- 66-01537 66-67 without A/C, 80 watt ...\$ 129.00 pr.

Features Pioneer speakers, 160 watts,

- 66-015372 66-67 without A/C .....\$ 185.00 pr.



- 68-01537 68-72 without A/C, 80 watt ...\$ 129.00 pr.

Features Pioneer speakers, 160 watts,

- 68-015372 68-72 without A/C .....\$ 185.00 pr.

## KICK PANEL SCREW KIT



- 67-015371 65-79 10 pieces .....\$ 4.00 kit

## KICK PANEL CABLES



- 65-01538 65-67 without AC .....\$ 59.00 pr.  
 68-01538 68-74 without AC .....\$ 59.00 pr.

## KICK PANEL CABLE RETAINING CLIP



- 68-015381 65-79 .....\$ 4.00 pr.

## KICK PANEL A/C ACTUATOR COVERS



- Black only  
 70-01541 70-79 .....\$ 25.00 ea.

\* The following items require additional shipping and handling.



# CHEVROLET NOVA PARTS

Car Shop Inc. 739 North Batavia Orange, California 92868

## DOOR PANEL MOLDINGS

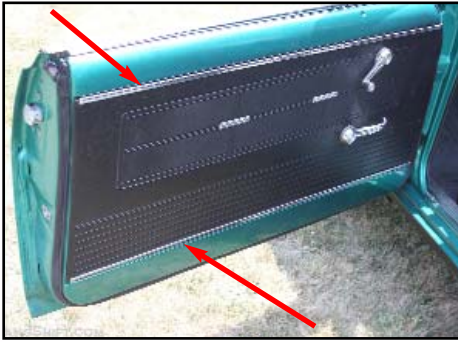

Interior door panel retainers, 2-door hardtop or sedan.

|          |       |                        |              |     |
|----------|-------|------------------------|--------------|-----|
| 62-01601 | 62-67 | upper, front, LH or RH | \$. \$ 30.00 | ea. |
| 62-01602 | 62-67 | lower, front, LH or RH | \$. \$ 30.00 | ea. |

Interior quarter trim panel retainers, 2-door hardtop or sedan.

|          |       |                 |              |     |
|----------|-------|-----------------|--------------|-----|
| 62-01603 | 62-65 | upper, rear, LH | \$. \$ 26.00 | ea. |
| 62-01604 | 62-65 | upper, rear, RH | \$. \$ 26.00 | ea. |
| 66-01603 | 66-67 | upper, rear, LH | \$. \$ 26.00 | ea. |
| 66-01604 | 66-67 | upper, rear, RH | \$. \$ 26.00 | ea. |
| 62-01605 | 62-67 | lower, rear, LH | \$. \$ 25.00 | ea. |
| 62-01606 | 62-67 | lower, rear, RH | \$. \$ 25.00 | ea. |

Interior door & quarter trim panel retainer set, 2-door hardtop or sedan.

|          |       |          |               |     |
|----------|-------|----------|---------------|-----|
| 62-01607 | 62-65 | set of 8 | \$. \$ 199.00 | set |
| 66-01608 | 66-67 | set of 8 | \$. \$ 199.00 | set |

## DOOR PANEL RETAINER MOLDING SCREW KIT



|           |       |           |             |     |
|-----------|-------|-----------|-------------|-----|
| 67-019245 | 62-67 | 18 pieces | \$. \$ 4.00 | kit |
|-----------|-------|-----------|-------------|-----|

## 1963 DOOR TRIM PANELS



### DOOR PANELS

1963 Nova & SS. 2-door coupe, convertible or sedan.

|           |    |            |               |     |
|-----------|----|------------|---------------|-----|
| 63-01620+ | 63 | Black      | \$. \$ 124.00 | pr. |
| 63-01621+ | 63 | Red        | \$. \$ 124.00 | pr. |
| 63-01622+ | 63 | Light Blue | \$. \$ 124.00 | pr. |
| 63-01623+ | 63 | Aqua       | \$. \$ 124.00 | pr. |
| 63-01624+ | 63 | White      | \$. \$ 124.00 | pr. |
| 63-01625+ | 63 | Saddle     | \$. \$ 124.00 | pr. |
| 63-01626+ | 63 | Fawn       | \$. \$ 124.00 | pr. |

## 1963 1/4 TRIM PANELS



### REAR 1/4 TRIM PANELS • COUPE • SEDAN •

1963 Nova & SS. 2-door coupe or sedan.

|           |    |            |              |     |
|-----------|----|------------|--------------|-----|
| 63-01630+ | 63 | Black      | \$. \$ 64.00 | pr. |
| 63-01631+ | 63 | Red        | \$. \$ 64.00 | pr. |
| 63-01632+ | 63 | Light Blue | \$. \$ 64.00 | pr. |
| 63-01633+ | 63 | Aqua       | \$. \$ 64.00 | pr. |
| 63-01634+ | 63 | White      | \$. \$ 64.00 | pr. |
| 63-01635+ | 63 | Saddle     | \$. \$ 64.00 | pr. |
| 63-01636+ | 63 | Fawn       | \$. \$ 64.00 | pr. |

### REAR 1/4 TRIM PANELS • CONVERTIBLE •

1963 Nova & SS.

|           |    |            |              |     |
|-----------|----|------------|--------------|-----|
| 63-01640+ | 63 | Black      | \$. \$ 64.00 | pr. |
| 63-01641+ | 63 | Red        | \$. \$ 64.00 | pr. |
| 63-01642+ | 63 | Light Blue | \$. \$ 64.00 | pr. |
| 63-01643+ | 63 | Aqua       | \$. \$ 64.00 | pr. |
| 63-01644+ | 63 | White      | \$. \$ 64.00 | pr. |
| 63-01645+ | 63 | Saddle     | \$. \$ 64.00 | pr. |
| 63-01646+ | 63 | Fawn       | \$. \$ 64.00 | pr. |

## 1963 4-DOOR & WAGON DOOR PANELS



### 4-DOOR • FRONT DOOR PANELS

1963 4-door wagon or 4-door sedan door panels.

|            |    |            |               |     |
|------------|----|------------|---------------|-----|
| 63-016204+ | 63 | Black      | \$. \$ 124.00 | pr. |
| 63-016214+ | 63 | Red        | \$. \$ 124.00 | pr. |
| 63-016224+ | 63 | Light Blue | \$. \$ 124.00 | pr. |
| 63-016234+ | 63 | Aqua       | \$. \$ 124.00 | pr. |
| 63-016244+ | 63 | White      | \$. \$ 124.00 | pr. |
| 63-016254+ | 63 | Saddle     | \$. \$ 124.00 | pr. |
| 63-016264+ | 63 | Fawn       | \$. \$ 124.00 | pr. |

### 4-DOOR • REAR DOOR PANELS

1963 4-door wagon or 4-door sedan door panels.

|            |    |            |               |     |
|------------|----|------------|---------------|-----|
| 63-016304+ | 63 | Black      | \$. \$ 124.00 | pr. |
| 63-016314+ | 63 | Red        | \$. \$ 124.00 | pr. |
| 63-016324+ | 63 | Light Blue | \$. \$ 124.00 | pr. |
| 63-016334+ | 63 | Aqua       | \$. \$ 124.00 | pr. |
| 63-016344+ | 63 | White      | \$. \$ 124.00 | pr. |
| 63-016354+ | 63 | Saddle     | \$. \$ 124.00 | pr. |
| 63-016364+ | 63 | Fawn       | \$. \$ 124.00 | pr. |

## 1964 DOOR & 1/4 TRIM PANELS

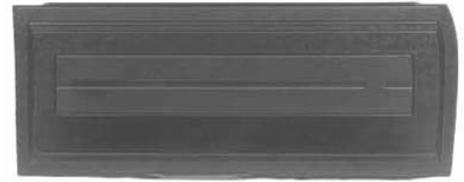

### DOOR PANELS

1964 Nova & SS. 2-door coupe or sedan.

|           |    |            |               |     |
|-----------|----|------------|---------------|-----|
| 64-01620+ | 64 | Black      | \$. \$ 124.00 | pr. |
| 64-01621+ | 64 | Red        | \$. \$ 124.00 | pr. |
| 64-01622+ | 64 | Light Blue | \$. \$ 124.00 | pr. |
| 64-01623+ | 64 | Aqua       | \$. \$ 124.00 | pr. |
| 64-01625+ | 64 | Saddle     | \$. \$ 124.00 | pr. |
| 64-01626+ | 64 | Light Fawn | \$. \$ 124.00 | pr. |



### REAR 1/4 TRIM PANELS • COUPE • SEDAN •

1964 Nova & SS. 2-door coupe or sedan.

|           |    |            |              |     |
|-----------|----|------------|--------------|-----|
| 64-01630+ | 64 | Black      | \$. \$ 64.00 | pr. |
| 64-01631+ | 64 | Red        | \$. \$ 64.00 | pr. |
| 64-01632+ | 64 | Light Blue | \$. \$ 64.00 | pr. |
| 64-01633+ | 64 | Aqua       | \$. \$ 64.00 | pr. |
| 64-01635+ | 64 | Saddle     | \$. \$ 64.00 | pr. |
| 64-01636+ | 64 | Light Fawn | \$. \$ 64.00 | pr. |

## 1964 4-DOOR & WAGON DOOR PANELS



### 4-DOOR • FRONT DOOR PANELS

1964 4-door wagon or 4-door sedan door panels.

|            |    |            |               |     |
|------------|----|------------|---------------|-----|
| 64-016204+ | 64 | Black      | \$. \$ 134.00 | pr. |
| 64-016214+ | 64 | Red        | \$. \$ 134.00 | pr. |
| 64-016224+ | 64 | Light Blue | \$. \$ 134.00 | pr. |
| 64-016234+ | 64 | Aqua       | \$. \$ 134.00 | pr. |
| 64-016254+ | 64 | Saddle     | \$. \$ 134.00 | pr. |
| 64-016264+ | 64 | Light Fawn | \$. \$ 134.00 | pr. |

### 4-DOOR • REAR DOOR PANELS

1964 4-door wagon or 4-door sedan door panels.

|            |    |            |               |     |
|------------|----|------------|---------------|-----|
| 64-016304+ | 64 | Black      | \$. \$ 134.00 | pr. |
| 64-016314+ | 64 | Red        | \$. \$ 134.00 | pr. |
| 64-016324+ | 64 | Light Blue | \$. \$ 134.00 | pr. |
| 64-016334+ | 64 | Aqua       | \$. \$ 134.00 | pr. |
| 64-016354+ | 64 | Saddle     | \$. \$ 134.00 | pr. |
| 64-016364+ | 64 | Light Fawn | \$. \$ 134.00 | pr. |

+ The following items require additional shipping and handling.

# CHEVROLET NOVA PARTS



Car Shop Inc. 739 North Batavia Orange, California 92868

## 1965 DOOR & 1/4 TRIM PANELS



### DOOR PANELS

1965 Nova & SS. 2-door coupe or sedan.

|           |                 |       |           |     |
|-----------|-----------------|-------|-----------|-----|
| 65-01620+ | 65 Black        | ..... | \$ 124.00 | pr. |
| 65-01621+ | 65 Red          | ..... | \$ 124.00 | pr. |
| 65-01622+ | 65 Light Blue   | ..... | \$ 124.00 | pr. |
| 65-01623+ | 65 Aqua         | ..... | \$ 124.00 | pr. |
| 65-01625+ | 65 Light Saddle | ..... | \$ 124.00 | pr. |
| 65-01626+ | 65 Light Fawn   | ..... | \$ 124.00 | pr. |



### REAR 1/4 TRIM PANELS • COUPE • SEDAN •

1964 Nova & SS. 2-door coupe or sedan.

|           |                 |       |          |     |
|-----------|-----------------|-------|----------|-----|
| 65-01630+ | 65 Black        | ..... | \$ 64.00 | pr. |
| 65-01631+ | 65 Red          | ..... | \$ 64.00 | pr. |
| 65-01632+ | 65 Light Blue   | ..... | \$ 64.00 | pr. |
| 65-01633+ | 65 Aqua         | ..... | \$ 64.00 | pr. |
| 65-01635+ | 65 Light Saddle | ..... | \$ 64.00 | pr. |
| 65-01636+ | 65 Light Fawn   | ..... | \$ 64.00 | pr. |

## 1965 4-DOOR & WAGON DOOR PANELS



### 4-DOOR • FRONT DOOR PANELS

1965 4-door wagon or 4-door sedan door panels.

|            |                 |       |           |     |
|------------|-----------------|-------|-----------|-----|
| 65-016204+ | 65 Black        | ..... | \$ 134.00 | pr. |
| 65-016214+ | 65 Red          | ..... | \$ 134.00 | pr. |
| 65-016224+ | 65 Light Blue   | ..... | \$ 134.00 | pr. |
| 65-016234+ | 65 Aqua         | ..... | \$ 134.00 | pr. |
| 65-016254+ | 65 Light Saddle | ..... | \$ 134.00 | pr. |
| 65-016264+ | 65 Light Fawn   | ..... | \$ 134.00 | pr. |

### 4-DOOR • REAR DOOR PANELS

1965 4-door wagon or 4-door sedan door panels.

|            |                 |       |           |     |
|------------|-----------------|-------|-----------|-----|
| 65-016304+ | 65 Black        | ..... | \$ 134.00 | pr. |
| 65-016314+ | 65 Red          | ..... | \$ 134.00 | pr. |
| 65-016324+ | 65 Light Blue   | ..... | \$ 134.00 | pr. |
| 65-016334+ | 65 Aqua         | ..... | \$ 134.00 | pr. |
| 65-016354+ | 65 Light Saddle | ..... | \$ 134.00 | pr. |
| 65-016364+ | 65 Light Fawn   | ..... | \$ 134.00 | pr. |

## 1966 DOOR & 1/4 TRIM PANELS



### DOOR PANELS

1966 Nova & SS. 2-door coupe or sedan.

|           |                |       |           |     |
|-----------|----------------|-------|-----------|-----|
| 66-01620+ | 66 Black       | ..... | \$ 134.00 | pr. |
| 66-01621+ | 66 Red         | ..... | \$ 134.00 | pr. |
| 66-01622+ | 66 Light Blue  | ..... | \$ 134.00 | pr. |
| 66-01623+ | 66 Aqua        | ..... | \$ 134.00 | pr. |
| 66-01626+ | 66 Light fawn  | ..... | \$ 134.00 | pr. |
| 66-01627+ | 66 Bright Blue | ..... | \$ 134.00 | pr. |



### REAR 1/4 TRIM PANELS • COUPE • SEDAN •

1966 Nova & SS. 2-door coupe or sedan.

|           |                |       |          |     |
|-----------|----------------|-------|----------|-----|
| 66-01630+ | 66 Black       | ..... | \$ 74.00 | pr. |
| 66-01631+ | 66 Red         | ..... | \$ 74.00 | pr. |
| 66-01632+ | 66 Light Blue  | ..... | \$ 74.00 | pr. |
| 66-01633+ | 66 Aqua        | ..... | \$ 74.00 | pr. |
| 66-01636+ | 66 Light Fawn  | ..... | \$ 74.00 | pr. |
| 66-01637+ | 66 Bright Blue | ..... | \$ 74.00 | pr. |

## 1966 4-DOOR & WAGON DOOR PANELS



### 4-DOOR • FRONT DOOR PANELS

1966 4-door wagon or 4-door sedan door panels.

|            |               |       |           |     |
|------------|---------------|-------|-----------|-----|
| 66-016204+ | 66 Black      | ..... | \$ 134.00 | pr. |
| 66-016214+ | 66 Red        | ..... | \$ 134.00 | pr. |
| 66-016224+ | 66 Light Blue | ..... | \$ 134.00 | pr. |
| 66-016234+ | 66 Aqua       | ..... | \$ 134.00 | pr. |
| 66-016264+ | 66 Light fawn | ..... | \$ 134.00 | pr. |

### 4-DOOR • REAR DOOR PANELS

1966 4-door wagon or 4-door sedan door panels.

|            |               |       |           |     |
|------------|---------------|-------|-----------|-----|
| 66-016304+ | 66 Black      | ..... | \$ 134.00 | pr. |
| 66-016314+ | 66 Red        | ..... | \$ 134.00 | pr. |
| 66-016324+ | 66 Light Blue | ..... | \$ 134.00 | pr. |
| 66-016334+ | 66 Aqua       | ..... | \$ 134.00 | pr. |
| 66-016364+ | 66 Light Fawn | ..... | \$ 134.00 | pr. |

## 1967 STANDARD DOOR & 1/4 TRIM PANELS

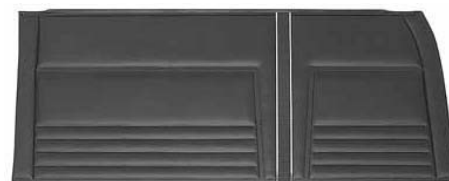

### DOOR PANELS

1967 Nova with standard interior. 2-door coupe or sedan.

|           |               |       |           |     |
|-----------|---------------|-------|-----------|-----|
| 67-01620+ | 67 Black      | ..... | \$ 134.00 | pr. |
| 67-01621+ | 67 Red        | ..... | \$ 134.00 | pr. |
| 67-01622+ | 67 Light Blue | ..... | \$ 134.00 | pr. |
| 67-01626+ | 67 Fawn       | ..... | \$ 134.00 | pr. |
| 67-01628+ | 67 Ivy Gold   | ..... | \$ 134.00 | pr. |



### REAR 1/4 TRIM PANELS • COUPE • SEDAN •

1967 Nova with standard interior. 2-door coupe or sedan.

|           |               |       |          |     |
|-----------|---------------|-------|----------|-----|
| 67-01630+ | 67 Black      | ..... | \$ 74.00 | pr. |
| 67-01631+ | 67 Red        | ..... | \$ 74.00 | pr. |
| 67-01632+ | 67 Light Blue | ..... | \$ 74.00 | pr. |
| 67-01636+ | 67 Fawn       | ..... | \$ 74.00 | pr. |
| 67-01638+ | 67 Ivy Gold   | ..... | \$ 74.00 | pr. |

## 1967 4-DOOR & WAGON DOOR PANELS



### 4-DOOR • FRONT DOOR PANELS

1967 4-door wagon or 4-door sedan door panels.

|            |               |       |           |     |
|------------|---------------|-------|-----------|-----|
| 67-016204+ | 67 Black      | ..... | \$ 134.00 | pr. |
| 67-016224+ | 67 Light Blue | ..... | \$ 134.00 | pr. |
| 67-016284+ | 67 Ivy Gold   | ..... | \$ 134.00 | pr. |



### 4-DOOR • REAR DOOR PANELS

1967 4-door wagon or 4-door sedan door panels.

|            |               |       |           |     |
|------------|---------------|-------|-----------|-----|
| 67-016304+ | 67 Black      | ..... | \$ 134.00 | pr. |
| 67-016324+ | 67 Light Blue | ..... | \$ 134.00 | pr. |
| 67-016384+ | 67 Ivy Gold   | ..... | \$ 134.00 | pr. |

+ The following items require additional shipping and handling.

Fax Order 1-714-771-0407 • Toll Free 1-800-235-2470 • [www.TruckandCarShop.com](http://www.TruckandCarShop.com) • 2014 Catalog



# CHEVROLET NOVA PARTS

Car Shop Inc. 739 North Batavia Orange, California 92868

## 1967 SS DOOR & 1/4 TRIM PANELS

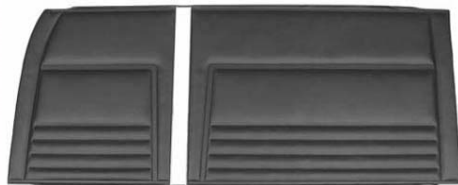
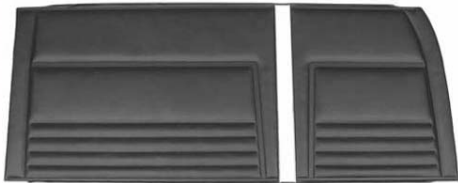

### DOOR PANELS

1967 Nova with SS interior. 2-door coupe.

|           |                |           |     |
|-----------|----------------|-----------|-----|
| 67-01640+ | 67 Black       | \$ 134.00 | pr. |
| 67-01641+ | 67 Red         | \$ 134.00 | pr. |
| 67-01642+ | 67 Bright Blue | \$ 134.00 | pr. |
| 67-01648+ | 67 Gold        | \$ 134.00 | pr. |



### REAR 1/4 TRIM PANELS • COUPE

1967 Nova with SS interior. 2-door coupe.

|           |                |          |     |
|-----------|----------------|----------|-----|
| 67-01650+ | 67 Black       | \$ 74.00 | pr. |
| 67-01651+ | 67 Red         | \$ 74.00 | pr. |
| 67-01652+ | 67 Bright Blue | \$ 74.00 | pr. |
| 67-01658+ | 67 Gold        | \$ 74.00 | pr. |

## 1968 DOOR & 1/4 TRIM PANELS "UNASSEMBLED"



### DOOR PANELS

1968 with standard interior. 2-door.

|           |             |           |     |
|-----------|-------------|-----------|-----|
| 68-01620+ | 68 Black    | \$ 197.00 | pr. |
| 68-01622+ | 68 Blue     | \$ 197.00 | pr. |
| 68-01628+ | 68 Ivy Gold | \$ 197.00 | pr. |



### REAR 1/4 TRIM PANELS

1968 with standard interior. 2-door.

|           |             |          |     |
|-----------|-------------|----------|-----|
| 68-01630+ | 68 Black    | \$ 86.00 | pr. |
| 68-01632+ | 68 Blue     | \$ 86.00 | pr. |
| 68-01638+ | 68 Ivy Gold | \$ 86.00 | pr. |



### DOOR PANELS

1968 with SS/Custom interior. 2-door.

|           |             |           |     |
|-----------|-------------|-----------|-----|
| 68-01640+ | 68 Black    | \$ 179.00 | pr. |
| 68-01642+ | 68 Blue     | \$ 179.00 | pr. |
| 68-01648+ | 68 Ivy Gold | \$ 179.00 | pr. |



### REAR 1/4 TRIM PANELS

1968 with SS/Custom interior. 2-door.

|           |             |          |     |
|-----------|-------------|----------|-----|
| 68-01650+ | 68 Black    | \$ 79.00 | pr. |
| 68-01652+ | 68 Blue     | \$ 79.00 | pr. |
| 68-01658+ | 68 Ivy Gold | \$ 79.00 | pr. |

## 1969-72 DOOR & 1/4 TRIM PANELS "UNASSEMBLED"



### DOOR PANELS

1969-70 with standard interior. 2-door.

|           |                        |           |     |
|-----------|------------------------|-----------|-----|
| 69-01620+ | 69-70 Black            | \$ 199.00 | pr. |
| 69-01621+ | 69 Light Green         | \$ 199.00 | pr. |
| 69-01622+ | 69-70 Light Blue       | \$ 199.00 | pr. |
| 69-01623+ | 69-70 Bright Blue      | \$ 199.00 | pr. |
| 69-01624+ | 70 Gold                | \$ 199.00 | pr. |
| 69-01625+ | 70 Dark Metallic Green | \$ 199.00 | pr. |



Unassembled Door Panels

### REAR 1/4 TRIM PANELS

1969-70 with standard interior. 2-door.

|           |                        |          |     |
|-----------|------------------------|----------|-----|
| 69-01630+ | 69-70 Black            | \$ 86.00 | pr. |
| 69-01631+ | 69 Light Green         | \$ 86.00 | pr. |
| 69-01632+ | 69-70 Light Blue       | \$ 86.00 | pr. |
| 69-01633+ | 69-70 Bright Blue      | \$ 86.00 | pr. |
| 69-01634+ | 70 Gold                | \$ 86.00 | pr. |
| 69-01635+ | 70 Dark Metallic Green | \$ 86.00 | pr. |



### DOOR PANELS

1971-72 with standard interior. 2-door.

|           |                  |           |     |
|-----------|------------------|-----------|-----|
| 71-01620+ | 71-72 Black      | \$ 199.00 | pr. |
| 71-01621+ | 71 Jade Green    | \$ 199.00 | pr. |
| 71-01622+ | 71-72 Dark Blue  | \$ 199.00 | pr. |
| 71-01624+ | 71-72 Sandalwood | \$ 199.00 | pr. |
| 71-01625+ | 72 Dark Green    | \$ 199.00 | pr. |

### REAR 1/4 TRIM PANELS

1971-72 with standard interior. 2-door.

|           |                  |          |     |
|-----------|------------------|----------|-----|
| 71-01630+ | 71-72 Black      | \$ 86.00 | pr. |
| 71-01631+ | 71 Jade Green    | \$ 86.00 | pr. |
| 71-01632+ | 71-72 Dark Blue  | \$ 86.00 | pr. |
| 71-01634+ | 71-72 Sandalwood | \$ 86.00 | pr. |
| 71-01635+ | 72 Dark Green    | \$ 86.00 | pr. |

+ The following items require additional shipping and handling.



# CHEVROLET NOVA PARTS



Car Shop Inc. 739 North Batavia Orange, California 92868

## 1969-72 DOOR & 1/4 TRIM PANELS "UNASSEMBLED"



### DOOR PANELS

1969 with SS interior. 2-door.

|           |    |                     |       |           |     |
|-----------|----|---------------------|-------|-----------|-----|
| 69-01640+ | 69 | Black               | ..... | \$ 199.00 | pr. |
| 69-01641+ | 69 | Red                 | ..... | \$ 199.00 | pr. |
| 69-01642+ | 69 | Light Blue          | ..... | \$ 199.00 | pr. |
| 69-01643+ | 69 | Bright Blue         | ..... | \$ 199.00 | pr. |
| 69-01644+ | 69 | Dark Green          | ..... | \$ 199.00 | pr. |
| 69-01645+ | 69 | Dark Metallic Green | ....  | \$ 199.00 | pr. |

### REAR 1/4 TRIM PANELS

1969 with SS interior. 2-door.

|           |    |                     |       |          |     |
|-----------|----|---------------------|-------|----------|-----|
| 69-01650+ | 69 | Black               | ..... | \$ 86.00 | pr. |
| 69-01651+ | 69 | Red                 | ..... | \$ 86.00 | pr. |
| 69-01652+ | 69 | Light Blue          | ..... | \$ 86.00 | pr. |
| 69-01653+ | 69 | Bright Blue         | ..... | \$ 86.00 | pr. |
| 69-01654+ | 69 | Dark Green          | ..... | \$ 86.00 | pr. |
| 69-01655+ | 69 | Dark Metallic Green | ....  | \$ 86.00 | pr. |



### DOOR PANELS

1970-72 with SS interior. 2-door.

|           |       |                     |       |           |     |
|-----------|-------|---------------------|-------|-----------|-----|
| 70-01640+ | 70-72 | Black               | ..... | \$ 199.00 | pr. |
| 70-01641+ | 70-72 | Sandalwood          | ..... | \$ 199.00 | pr. |
| 70-01642+ | 70    | Gold                | ..... | \$ 199.00 | pr. |
| 70-01643+ | 70    | Light Blue          | ..... | \$ 199.00 | pr. |
| 70-01644+ | 70    | Light Saddle        | ..... | \$ 199.00 | pr. |
| 70-01645+ | 70    | Dark Metallic Green | ....  | \$ 199.00 | pr. |
| 71-01644+ | 71    | Dark Saddle         | ..... | \$ 199.00 | pr. |
| 71-01645+ | 71    | Jade Green          | ..... | \$ 199.00 | pr. |
| 72-01646+ | 72    | Dark Green          | ..... | \$ 199.00 | pr. |
| 72-01647+ | 72    | Tan                 | ..... | \$ 199.00 | pr. |
| 71-01648+ | 71    | Dark Blue           | ..... | \$ 199.00 | pr. |

### REAR 1/4 TRIM PANELS

1970-72 with SS interior. 2-door.

|           |       |                     |       |          |     |
|-----------|-------|---------------------|-------|----------|-----|
| 70-01650+ | 70-72 | Black               | ..... | \$ 86.00 | pr. |
| 70-01651+ | 70-72 | Sandalwood          | ..... | \$ 86.00 | pr. |
| 70-01652+ | 70    | Gold                | ..... | \$ 86.00 | pr. |
| 70-01653+ | 70    | Light Blue          | ..... | \$ 86.00 | pr. |
| 70-01654+ | 70    | Light Saddle        | ..... | \$ 86.00 | pr. |
| 70-01655+ | 70    | Dark Metallic Green | ....  | \$ 86.00 | pr. |
| 71-01654+ | 71    | Dark Saddle         | ..... | \$ 86.00 | pr. |
| 71-01655+ | 71    | Jade Green          | ..... | \$ 86.00 | pr. |
| 72-01656+ | 72    | Dark Green          | ..... | \$ 86.00 | pr. |
| 72-01657+ | 72    | Tan                 | ..... | \$ 86.00 | pr. |
| 71-01658+ | 71    | Dark Blue           | ..... | \$ 86.00 | pr. |

## 1968-70 4-DOOR & WAGON DOOR PANELS



### 4-DOOR • FRONT DOOR PANELS

1968-70 4-door wagon or 4-door sedan door panels.

|            |       |                     |       |           |     |
|------------|-------|---------------------|-------|-----------|-----|
| 68-016204+ | 68-70 | Black               | ..... | \$ 199.00 | pr. |
| 69-016224+ | 69-70 | Light Blue          | ..... | \$ 199.00 | pr. |
| 68-016234+ | 68    | Medium Blue         | ..... | \$ 199.00 | pr. |
| 69-016244+ | 69-70 | Gold                | ..... | \$ 199.00 | pr. |
| 68-016254+ | 68    | Ivy Gold            | ..... | \$ 199.00 | pr. |
| 69-016264+ | 69-70 | Light Green         | ..... | \$ 199.00 | pr. |
| 68-016274+ | 69-70 | Dark Metallic Green | ....  | \$ 199.00 | pr. |



### 4-DOOR • REAR DOOR PANELS

1968-70 4-door wagon or 4-door sedan door panels.

|            |       |                     |       |           |     |
|------------|-------|---------------------|-------|-----------|-----|
| 68-016304+ | 68-70 | Black               | ..... | \$ 199.00 | pr. |
| 69-016324+ | 69-70 | Light Blue          | ..... | \$ 199.00 | pr. |
| 68-016334+ | 68    | Medium Blue         | ..... | \$ 199.00 | pr. |
| 69-016344+ | 69-70 | Gold                | ..... | \$ 199.00 | pr. |
| 68-016354+ | 68    | Ivy Gold            | ..... | \$ 199.00 | pr. |
| 69-016364+ | 69-70 | Light Green         | ..... | \$ 199.00 | pr. |
| 69-016374+ | 69-70 | Dark Metallic Green | ....  | \$ 199.00 | pr. |

## 1971-72 4-DOOR & WAGON DOOR PANELS



### 4-DOOR • FRONT DOOR PANELS

1971-72 4-door wagon or 4-door sedan door panels.

|            |       |            |       |           |     |
|------------|-------|------------|-------|-----------|-----|
| 71-016204+ | 71-72 | Black      | ..... | \$ 199.00 | pr. |
| 71-016214+ | 71    | Jade Green | ..... | \$ 199.00 | pr. |
| 71-016224+ | 71-72 | Dark Blue  | ..... | \$ 199.00 | pr. |
| 72-016234+ | 72    | Dark Green | ..... | \$ 199.00 | pr. |
| 71-016244+ | 71-72 | Sandalwood | ..... | \$ 199.00 | pr. |

### 4-DOOR • REAR DOOR PANELS

1971-72 4-door wagon or 4-door sedan door panels.

|            |       |            |       |           |     |
|------------|-------|------------|-------|-----------|-----|
| 71-016304+ | 71-72 | Black      | ..... | \$ 199.00 | pr. |
| 71-016314+ | 71    | Jade Green | ..... | \$ 199.00 | pr. |
| 71-016324+ | 71-72 | Dark Blue  | ..... | \$ 199.00 | pr. |
| 72-016334+ | 72    | Dark Green | ..... | \$ 199.00 | pr. |
| 71-016344+ | 71-72 | Sandalwood | ..... | \$ 199.00 | pr. |

## 1968-1972 DOOR & QUARTER TRIM PANELS UNASSEMBLED OR FULLY ASSEMBLED

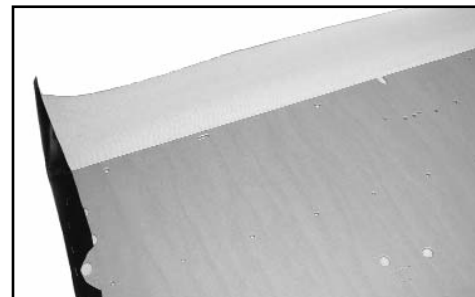

### UNASSEMBLED

Unassembled Door Panels come pre-attached to a rigid, water resistant backing board. You will need to attach the new panel to the original metal top backing rail that mounts to the door. It is also necessary to install the inner window felts, molding and door lock knob ferrules.

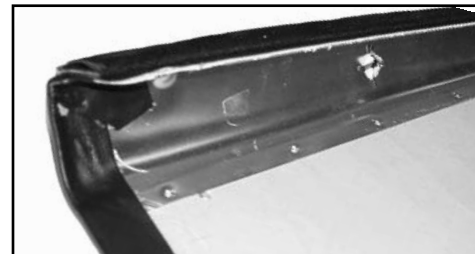
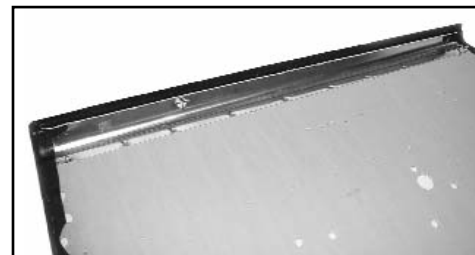

### FULLY ASSEMBLED

Fully Assembled Door Panels make installation a breeze and feature the same high quality as our unassembled panels. Everything is pre-attached (chrome molding, metal top backing rails, door lock knob ferrules and inside window felts), so all you need to do is hang it on your door. They do not include door panel attachment clips or nameplates. Available in all of the factory original colors.

+ The following items require additional shipping and handling.

Fax Order 1-714-771-0407 • Toll Free 1-800-235-2470 • [www.TruckandCarShop.com](http://www.TruckandCarShop.com) • 2014 Catalog



# CHEVROLET NOVA PARTS

Car Shop Inc. 739 North Batavia Orange, California 92868

## 1968 DOOR & 1/4 TRIM PANELS "ASSEMBLED"

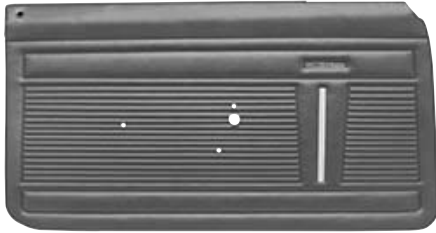

### ASSEMBLED DOOR PANELS

1968 with standard interior. 2-door.

- 68-01660+ 68 Black .....\$ 319.00 pr.
- 68-01662+ 68 Medium Blue .....\$ 319.00 pr.
- 68-01668+ 68 Ivy Gold .....\$ 319.00 pr.



### ASSEMBLED REAR 1/4 TRIM PANELS

1968 with standard interior. 2-door.

- 68-01670+ 68 Black .....\$ 215.00 pr.
- 68-01672+ 68 Medium Blue .....\$ 215.00 pr.
- 68-01678+ 68 Ivy Gold .....\$ 215.00 pr.

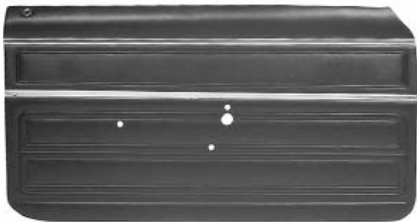

### ASSEMBLED DOOR PANELS

1968 with SS/Custom interior. 2-door.

- 68-01680+ 68 Black .....\$ 319.00 pr.
- 68-01682+ 68 Blue .....\$ 319.00 pr.
- 68-01688+ 68 Ivy Gold .....\$ 319.00 pr.



### ASSEMBLED REAR 1/4 TRIM PANELS

1968 with SS/Custom interior. 2-door.

- 68-01690+ 68 Black .....\$ 215.00 pr.
- 68-01692+ 68 Blue .....\$ 215.00 pr.
- 68-01698+ 68 Ivy Gold .....\$ 215.00 pr.

## 1969-72 DOOR & 1/4 TRIM PANELS "ASSEMBLED"



### ASSEMBLED DOOR PANELS

1969-70 with standard interior. 2-door.

- 69-01660+ 69-70 Black .....\$ 319.00 pr.
- 69-01661+ 69 Light Green .....\$ 319.00 pr.
- 69-01662+ 69-70 Light Blue .....\$ 319.00 pr.
- 69-01663+ 69-70 Bright Blue .....\$ 319.00 pr.
- 69-01664+ 70 Gold .....\$ 319.00 pr.
- 69-01665+ 70 Dark Metallic Green ...\$ 319.00 pr.



### ASSEMBLED REAR 1/4 TRIM PANELS

1969-70 with standard interior. 2-door.

- 69-01670+ 69-70 Black .....\$ 215.00 pr.
- 69-01671+ 69 Light Green .....\$ 215.00 pr.
- 69-01672+ 69-70 Light Blue .....\$ 215.00 pr.
- 69-01673+ 69-70 Bright Blue .....\$ 215.00 pr.
- 69-01674+ 70 Gold .....\$ 215.00 pr.
- 69-01675+ 70 Dark Metallic Green ...\$ 215.00 pr.



### ASSEMBLED DOOR PANELS

1971-72 with standard interior. 2-door.

- 71-01660+ 71-72 Black .....\$ 319.00 pr.
- 71-01661+ 71 Jade Green .....\$ 319.00 pr.
- 71-01662+ 71-72 Dark Blue .....\$ 319.00 pr.
- 71-01664+ 71-72 Sandalwood .....\$ 319.00 pr.
- 71-01665+ 72 Dark Green .....\$ 319.00 pr.

### ASSEMBLED REAR 1/4 TRIM PANELS

1971-72 with standard interior. 2-door.

- 71-01670+ 71-72 Black .....\$ 215.00 pr.
- 71-01671+ 71 Jade Green .....\$ 215.00 pr.
- 71-01672+ 71-72 Dark Blue .....\$ 215.00 pr.
- 71-01674+ 71-72 Sandalwood .....\$ 215.00 pr.
- 71-01675+ 72 Dark Green .....\$ 215.00 pr.

## 1969-72 DOOR & 1/4 TRIM PANELS "ASSEMBLED"

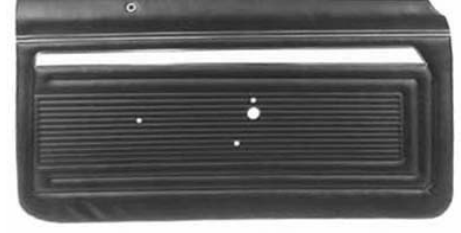

### ASSEMBLED DOOR PANELS

1969 with SS interior. 2-door.

- 69-01680+ 69 Black .....\$ 319.00 pr.
- 69-01681+ 69 Red .....\$ 319.00 pr.
- 69-01682+ 69 Light Blue .....\$ 319.00 pr.
- 69-01683+ 69 Bright Blue .....\$ 319.00 pr.
- 69-01684+ 69 Dark Metallic Green ...\$ 319.00 pr.
- 69-01685+ 69 Light Green .....\$ 319.00 pr.



### ASSEMBLED REAR 1/4 TRIM PANELS

1969 with SS interior. 2-door.

- 69-01690+ 69 Black .....\$ 215.00 pr.
- 69-01691+ 69 Red .....\$ 215.00 pr.
- 69-01692+ 69 Light Blue .....\$ 215.00 pr.
- 69-01693+ 69 Bright Blue .....\$ 215.00 pr.
- 69-01694+ 69 Dark Metallic Green ...\$ 215.00 pr.
- 69-01695+ 69 Light Green .....\$ 215.00 pr.



**Showroom hours:**  
**TUESDAY - FRIDAY: 8:30AM to 4:30PM**  
**SATURDAY: 8:30AM to 3:30PM**  
**Phone order desk hours:**  
**MONDAY - FRIDAY: 8:30AM to 4:30PM**

\* The following items require additional shipping and handling.

# CHEVROLET NOVA PARTS



Car Shop Inc. 739 North Batavia Orange, California 92868

## 1969-72 DOOR & 1/4 TRIM PANELS "ASSEMBLED"



### ASSEMBLED DOOR PANELS

1970-72 with SS interior. 2-door.

|           |       |                     |           |     |
|-----------|-------|---------------------|-----------|-----|
| 70-01680+ | 70-72 | Black               | \$ 319.00 | pr. |
| 70-01681+ | 70-72 | Sandalwood          | \$ 319.00 | pr. |
| 70-01682+ | 70    | Gold                | \$ 319.00 | pr. |
| 70-01683+ | 70    | Light Blue          | \$ 319.00 | pr. |
| 70-01684+ | 70    | Light Saddle        | \$ 319.00 | pr. |
| 70-01685+ | 70    | Dark Metallic Green | \$ 319.00 | pr. |
| 71-01684+ | 71    | Dark Saddle         | \$ 319.00 | pr. |
| 71-01685+ | 71    | Jade Green          | \$ 319.00 | pr. |
| 72-01686+ | 72    | Dark Green          | \$ 319.00 | pr. |
| 72-01687+ | 72    | Tan                 | \$ 319.00 | pr. |
| 71-01688+ | 71    | Dark Blue           | \$ 319.00 | pr. |



### ASSEMBLED REAR 1/4 TRIM PANELS

1970-72 with SS interior. 2-door.

|           |       |                     |           |     |
|-----------|-------|---------------------|-----------|-----|
| 70-01690+ | 70-72 | Black               | \$ 215.00 | pr. |
| 70-01691+ | 70-72 | Sandalwood          | \$ 215.00 | pr. |
| 70-01692+ | 70    | Gold                | \$ 215.00 | pr. |
| 70-01693+ | 70    | Light Blue          | \$ 215.00 | pr. |
| 70-01694+ | 70    | Light Saddle        | \$ 215.00 | pr. |
| 70-01695+ | 70    | Dark Metallic Green | \$ 215.00 | pr. |
| 71-01694+ | 71    | Dark Saddle         | \$ 215.00 | pr. |
| 71-01695+ | 71    | Jade Green          | \$ 215.00 | pr. |
| 72-01696+ | 72    | Dark Green          | \$ 215.00 | pr. |
| 72-01697+ | 72    | Tan                 | \$ 215.00 | pr. |
| 71-01698+ | 71    | Dark Blue           | \$ 215.00 | pr. |

## DOOR PANEL WATER SHIELDS

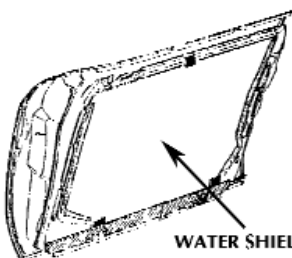

|          |       |                        |          |     |
|----------|-------|------------------------|----------|-----|
| 68-02114 | 68-72 | 2-door, door & quarter | \$ 26.00 | set |
|----------|-------|------------------------|----------|-----|

## DOOR PANEL EMBLEMS



|           |       |                  |          |     |
|-----------|-------|------------------|----------|-----|
| 66-01746  | 66-67 | Chevy II, USA    | \$ 44.00 | pr. |
| 66-017461 | 66-67 | Chevy II, import | \$ 33.00 | pr. |



|          |       |      |          |     |
|----------|-------|------|----------|-----|
| 69-01746 | 69-72 | Nova | \$ 36.00 | pr. |
|----------|-------|------|----------|-----|

## DOOR PANEL MOUNTING SCREW KIT



Includes package of 8 countersunk screws with washers. Can be used on standard or deluxe door panels, also used on rear arm rest covers.

|          |       |           |         |     |
|----------|-------|-----------|---------|-----|
| 67-02117 | 68-74 | Screw kit | \$ 2.00 | set |
|----------|-------|-----------|---------|-----|

## DOOR PANEL INSTALLATION CLIP KIT



Complete set of 12 clips used to install the front panels.

|          |       |  |         |     |
|----------|-------|--|---------|-----|
| 67-02118 | 62-74 |  | \$ 5.00 | set |
|----------|-------|--|---------|-----|

## DOOR PANEL MOUNTING PLUGS



Plastic plugs in the door frame secures panel clips. 12 pcs.

|          |       |  |         |     |
|----------|-------|--|---------|-----|
| 67-02119 | 62-74 |  | \$ 8.00 | set |
|----------|-------|--|---------|-----|

## DOOR PANEL MOUNTING KIT



Includes package of 8 countersunk screws with correct small washers, 12 door panel mounting clips & 12 mounting plugs.

|           |       |           |          |     |
|-----------|-------|-----------|----------|-----|
| 67-021195 | 68-74 | 32 pieces | \$ 14.00 | kit |
|-----------|-------|-----------|----------|-----|

## CONVERTIBLE REAR ARM REST COVERS

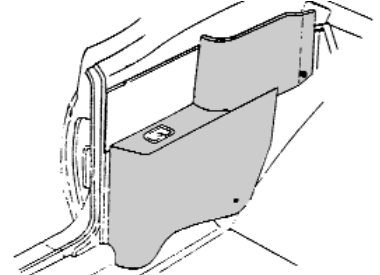

Pre-sewn vinyl covers to finish up your interior. Set includes left and right side covers.

|          |       |            |          |     |
|----------|-------|------------|----------|-----|
| 62-02120 | 62-63 | Black      | \$ 75.00 | set |
| 62-02121 | 62    | Bright Red | \$ 75.00 | set |
| 63-02122 | 63    | Red        | \$ 75.00 | set |
| 62-02123 | 62-63 | Aqua       | \$ 75.00 | set |
| 62-02124 | 62-63 | Light Blue | \$ 75.00 | set |
| 62-02125 | 62-63 | Fawn       | \$ 75.00 | set |
| 62-02126 | 62-63 | Saddle     | \$ 75.00 | set |
| 62-02127 | 62-63 | White      | \$ 75.00 | set |

## REAR ARM REST ASH TRAYS



|          |       |             |          |     |
|----------|-------|-------------|----------|-----|
| 59-06201 | 62-63 | convertible | \$ 17.00 | ea. |
|----------|-------|-------------|----------|-----|



|          |       |                |          |     |
|----------|-------|----------------|----------|-----|
| 64-01809 | 62-64 | 2-door hardtop | \$ 40.00 | pr. |
|          | 62-67 | 4-door & wagon |          |     |



|          |       |        |          |     |
|----------|-------|--------|----------|-----|
| 62-02211 | 65-67 | 2-door | \$ 50.00 | pr. |
|----------|-------|--------|----------|-----|



|           |       |             |          |     |
|-----------|-------|-------------|----------|-----|
| 68-022131 | 70-79 | with insert | \$ 30.00 | ea. |
|-----------|-------|-------------|----------|-----|



|          |       |             |          |     |
|----------|-------|-------------|----------|-----|
| 68-02214 | 70-79 | insert only | \$ 13.00 | ea. |
|----------|-------|-------------|----------|-----|

+ The following items require additional shipping and handling.

Fax Order 1-714-771-0407 • Toll Free 1-800-235-2470 • [www.TruckandCarShop.com](http://www.TruckandCarShop.com) • 2014 Catalog



# CHEVROLET NOVA PARTS

Car Shop Inc. 739 North Batavia Orange, California 92868

## DOOR LOCK FERRULES



67-02218 62-66 plastic .....\$ 5.00 pr.



Replacement.  
68-02219 68-79 chrome .....\$ 6.00 pr.  
Reproduction of factory originals with correct narrow trim ring.  
68-022191 68-79 chrome .....\$ 11.00 pr.

## DOOR LOCK KNOBS



61-06437 62-66 Chrome .....\$ 5.00 pr.  
61-06436 62-66 Black .....\$ 4.00 pr.  
61-064361 62-66 Turquoise .....\$ 8.00 pr.  
61-064362 62-66 Aqua .....\$ 8.00 pr.  
61-064363 62-66 Light Blue .....\$ 8.00 pr.  
61-064364 62-66 Marina Blue .....\$ 8.00 pr.  
61-064365 62-66 Bright Red .....\$ 8.00 pr.  
61-064366 62-66 Dark Red .....\$ 8.00 pr.  
61-064367 62-66 Light Green .....\$ 8.00 pr.  
61-064368 62-66 White .....\$ 8.00 pr.  
61-064369 62-66 Saddle .....\$ 8.00 pr.  
61-064371 62-66 Lt Fawn/Oyster .....\$ 8.00 pr.  
61-064372 62-66 Lt Fawn/Beige .....\$ 8.00 pr.  
61-064373 62-66 Dark Metallic Fawn ...\$ 8.00 pr.



67-02222 67 chrome .....\$ 68.00 pr.



Round head.  
68-02222 68-69 chrome, ribbed .....\$ 5.00 pr.  
68-02223 68-69 black, ribbed .....\$ 5.00 pr.



70-02224 70-79 chrome, smooth .....\$ 5.00 pr.  
68-02225 68-79 black, smooth .....\$ 5.00 pr.  
68-02226 68-79 red, smooth .....\$ 5.00 pr.  
68-02228 68-79 white, smooth .....\$ 5.00 pr.  
68-02229 68-79 brown, smooth .....\$ 5.00 pr.

## POWER DOOR LOCK SWITCH



73-022302 75-77 chrome .....\$ 52.00 ea.

## INNER DOOR LOCK ROD



Inner door lock rod & bellcrank.  
69-02232 69-79 LH or RH .....\$ 9.50 ea.

## INNER DOOR LOCK BELLCRANK CLIP



2 clips required to mount 1 bellcrank to door frame.  
69-02233 69-79 .....\$ 4.00 ea.

## WINDLACE END CAPS



This is the cap that sits along the top of the door jamb.  
62-02301 62-67 made in USA .....\$ 22.00 pr.

## DOOR JAMB EDGE WINDLACE



68-023031 68-72 Black, replacement ...\$ 27.00 pr.

## INTERIOR 1/4 PILLAR POST COVERS



68-02351 68-72 2-door, black .....\$ 99.00 pr.

## FRONT ARM REST BASES



64-01644 62-64 2 door, Front  
62-67 4 door, Front .....\$ 28.00 pr.

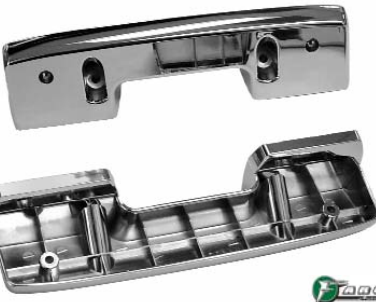

67-02313 65-67 Front .....\$ 24.00 pr.



Replacement, thick style base, originals were thin on the bottom.  
68-02314 68-72 Black, LH .....\$ 17.00 ea.  
68-02315 68-72 Black, RH .....\$ 17.00 ea.  
68-023161 68 Medium Blue, LH ....\$ 20.00 ea.  
68-023162 68 Medium Blue, RH ....\$ 20.00 ea.  
68-023171 68 Ivy Gold, LH .....\$ 20.00 ea.  
68-023172 68 Ivy Gold, RH .....\$ 20.00 ea.  
68-023181 69 Red, LH .....\$ 20.00 ea.  
68-023182 69 Red, RH .....\$ 20.00 ea.  
69-023191 69-72 Dark Green, LH ....\$ 20.00 ea.  
69-023192 69-72 Dark Green, RH ....\$ 20.00 ea.  
69-023201 71 Dark Blue, LH .....\$ 20.00 ea.  
69-023202 71 Dark Blue, RH .....\$ 20.00 ea.

# CHEVROLET NOVA PARTS



Car Shop Inc. 739 North Batavia Orange, California 92868

## REAR ARM REST BASES



Fits 1962-1964 2-door rear, & 1962-1967 4-door rear.

Plastic-Chrome plated rear arm rest bases.

|          |       |        |              |
|----------|-------|--------|--------------|
| 64-01801 | 62-64 | 2 door |              |
|          | 62-67 | 4 door | \$ 34.00 pr. |



Fits 1965-67 2-door rear.

Plastic-Chrome plated rear arm rest bases.

|          |       |         |              |
|----------|-------|---------|--------------|
| 65-01801 | 65-67 | LH & RH | \$ 72.00 pr. |
|----------|-------|---------|--------------|

## ARM REST SCREWS



Front arm rest base to door screw kits, mounts 2 arm rests.

|           |       |                  |             |
|-----------|-------|------------------|-------------|
| 67-02322  | 62-67 | 4-pieces         | \$ 2.00 kit |
| 68-02323  | 68-72 | 6-pieces, zinc   | \$ 3.00 kit |
| 68-023231 | 68-72 | 6-pieces, chrome | \$ 6.00 kit |



Rear arm rest base to door screw kit, mounts 2 arm rests.

|          |       |          |             |
|----------|-------|----------|-------------|
| 64-01655 | 62-64 | 6-pieces | \$ 2.00 kit |
|----------|-------|----------|-------------|



Arm rest pad to base screw kit, mounts 2 arm rest pads.

|          |       |          |             |
|----------|-------|----------|-------------|
| 67-02324 | 62-72 | 4-pieces | \$ 1.50 kit |
|----------|-------|----------|-------------|

## ARM REST PADS



Fits 1962-1964 2-door & 1962-1964 4-door front.

Injection molded arm rest pads, sold each.

Seville grain

|          |       |                      |              |
|----------|-------|----------------------|--------------|
| 64-01701 | 62-64 | Black, LH or RH      | \$ 19.00 ea. |
| 64-01702 | 63-64 | Red, LH or RH        | \$ 19.00 ea. |
| 64-01704 | 62-64 | Aqua, LH or RH       | \$ 19.00 ea. |
| 64-01705 | 62-64 | White, LH or RH      | \$ 19.00 ea. |
| 64-01706 | 62-64 | Light Blue, LH or RH | \$ 19.00 ea. |
| 64-01707 | 64    | Fawn, LH or RH       | \$ 19.00 ea. |
| 64-01708 | 62-64 | Saddle, LH or RH     | \$ 19.00 ea. |

Fits 1962-1964 2-door & 1962-1964 4-door front.

Original grain vinyl wrapped arm rest pads, sold in pairs.

Seville grain vinyl

|           |       |            |              |
|-----------|-------|------------|--------------|
| 64-017011 | 62-64 | Black      | \$ 52.00 pr. |
| 62-017021 | 62    | Bright Red | \$ 52.00 pr. |
| 64-017021 | 63-64 | Red        | \$ 52.00 pr. |
| 64-017041 | 62-64 | Aqua       | \$ 52.00 pr. |
| 64-017051 | 62-64 | White      | \$ 52.00 pr. |
| 64-017061 | 62-64 | Light Blue | \$ 52.00 pr. |
| 62-017071 | 62-63 | Fawn       | \$ 52.00 pr. |
| 64-017071 | 64    | Light Fawn | \$ 52.00 pr. |
| 64-017081 | 62-64 | Saddle     | \$ 52.00 pr. |

Fits 1965-1967 4-door front.

Original grain vinyl wrapped arm rest pads, sold in pairs.

Madrid grain vinyl

|           |       |                |              |
|-----------|-------|----------------|--------------|
| 65-017011 | 65-67 | Black          | \$ 52.00 pr. |
| 65-017021 | 65-66 | Red            | \$ 52.00 pr. |
| 65-017031 | 65-66 | Aqua/Turquoise | \$ 52.00 pr. |
| 65-017041 | 65-67 | Light Blue     | \$ 52.00 pr. |
| 65-017051 | 65-66 | Fawn           | \$ 52.00 pr. |
| 65-017061 | 65    | Saddle         | \$ 52.00 pr. |
| 65-017071 | 67    | Ivy Gold       | \$ 52.00 pr. |



Fits 1965-67 2-door.

Injection molded arm rest pads, sold each.

|          |       |                 |              |
|----------|-------|-----------------|--------------|
| 67-02325 | 65-67 | Black, LH or RH | \$ 19.00 ea. |
|----------|-------|-----------------|--------------|

Fits 1965-67 2-door.

Original grain vinyl wrapped arm rest pads, sold in pairs.

|           |       |             |              |
|-----------|-------|-------------|--------------|
| 67-023251 | 65-67 | Black       | \$ 52.00 pr. |
| 67-023261 | 65-67 | Red         | \$ 52.00 pr. |
| 67-023271 | 65-67 | Light Blue  | \$ 52.00 pr. |
| 67-023281 | 67    | Gold        | \$ 52.00 pr. |
| 65-023282 | 65-66 | Aqua        | \$ 52.00 pr. |
| 66-023283 | 66-67 | Bright Blue | \$ 52.00 pr. |
| 65-023284 | 65-66 | Fawn        | \$ 52.00 pr. |
| 65-023285 | 65    | Saddle      | \$ 52.00 pr. |
| 67-023286 | 67    | Ivy Gold    | \$ 52.00 pr. |

## ARM REST PADS



Injection molded arm rest pads, sold each.

|          |       |           |              |
|----------|-------|-----------|--------------|
| 68-02329 | 68-72 | Black, LH | \$ 19.00 ea. |
| 68-02330 | 68-72 | Black, RH | \$ 19.00 ea. |



Original grain vinyl wrapped arm rest pads, sold each.

|           |       |                    |              |
|-----------|-------|--------------------|--------------|
| 68-023291 | 68-72 | Black, LH          | \$ 26.00 ea. |
| 68-023301 | 68-72 | Black, RH          | \$ 26.00 ea. |
| 68-023331 | 68    | Blue, LH           | \$ 26.00 ea. |
| 68-023341 | 68    | Blue, RH           | \$ 26.00 ea. |
| 68-023351 | 68    | Ivy Gold, LH       | \$ 26.00 ea. |
| 68-023361 | 68    | Ivy Gold, RH       | \$ 26.00 ea. |
| 68-023311 | 69    | Red, LH            | \$ 26.00 ea. |
| 68-023321 | 69    | Red, RH            | \$ 26.00 ea. |
| 69-01729  | 69    | Bright Blue, LH    | \$ 26.00 ea. |
| 69-01730  | 69    | Bright Blue, RH    | \$ 26.00 ea. |
| 68-01727  | 69    | Light Green, LH    | \$ 26.00 ea. |
| 68-01728  | 69    | Light Green, RH    | \$ 26.00 ea. |
| 69-01727  | 69-70 | Light Blue, LH     | \$ 26.00 ea. |
| 69-01728  | 69-70 | Light Blue, RH     | \$ 26.00 ea. |
| 68-01725  | 69-70 | Dk. Met. Green, LH | \$ 26.00 ea. |
| 68-01726  | 69-70 | Dk. Met. Green, RH | \$ 26.00 ea. |
| 70-01733  | 70    | Gold, LH           | \$ 26.00 ea. |
| 70-01734  | 70    | Gold, RH           | \$ 26.00 ea. |
| 70-01731  | 70    | Light Saddle, LH   | \$ 26.00 ea. |
| 70-01732  | 70    | Light Saddle, RH   | \$ 26.00 ea. |
| 71-01739  | 70-71 | Sandalwood, LH     | \$ 26.00 ea. |
| 71-01740  | 70-71 | Sandalwood, RH     | \$ 26.00 ea. |
| 71-01737  | 71    | Dark Blue, LH      | \$ 26.00 ea. |
| 71-01738  | 71    | Dark Blue, RH      | \$ 26.00 ea. |
| 71-01745  | 71    | Jade Green, LH     | \$ 26.00 ea. |
| 71-01746  | 71    | Jade Green, RH     | \$ 26.00 ea. |
| 71-01741  | 71    | Dk Saddle, LH      | \$ 26.00 ea. |
| 71-01742  | 71    | Dk Saddle, RH      | \$ 26.00 ea. |
| 72-01745  | 72    | Tan, LH            | \$ 26.00 ea. |
| 72-01746  | 72    | Tan, RH            | \$ 26.00 ea. |
| 72-01747  | 72    | Covert, LH         | \$ 26.00 ea. |
| 72-01748  | 72    | Covert, RH         | \$ 26.00 ea. |
| 72-01749  | 72    | Dark Green, LH     | \$ 26.00 ea. |
| 72-01750  | 72    | Dark Green, RH     | \$ 26.00 ea. |

CHECK OUR Quality!

\* The following items require additional shipping and handling.

Fax Order 1-714-771-0407 • Toll Free 1-800-235-2470 • [www.TruckandCarShop.com](http://www.TruckandCarShop.com) • 2014 Catalog



# CHEVROLET NOVA PARTS

Car Shop Inc. 739 North Batavia Orange, California 92868

## REAR ARM REST PADS



Fits 1962-1964 2-door rear, & 1962-1964 4-door rear.

Injection molded arm rest pads, sold each.

|          |       |                      |       |
|----------|-------|----------------------|-------|
| 64-01749 | 62-64 | Black, LH or RH      | 19.00 |
| 64-01750 | 62-64 | Red, LH or RH        | 19.00 |
| 64-01751 | 62-64 | Dk Blue, LH or RH    | 19.00 |
| 64-01752 | 62-64 | Aqua, LH or RH       | 19.00 |
| 64-01753 | 62-64 | White, LH or RH      | 19.00 |
| 64-01754 | 62-64 | Light Blue, LH or RH | 19.00 |
| 64-01755 | 64    | Fawn, LH or RH       | 19.00 |
| 64-01756 | 62-64 | Saddle, LH or RH     | 19.00 |

Fits 1962-1964 2-door rear, & 1962-1964 4-door rear.

Original grain vinyl wrapped arm rest pads, sold in pairs.

|           |       |            |       |     |
|-----------|-------|------------|-------|-----|
| 64-017491 | 62-64 | Black      | 52.00 | pr. |
| 62-017501 | 62    | Bright Red | 52.00 | pr. |
| 64-017501 | 63-64 | Red        | 52.00 | pr. |
| 64-017521 | 62-64 | Aqua       | 52.00 | pr. |
| 64-017531 | 62-64 | White      | 52.00 | pr. |
| 64-017541 | 62-64 | Light Blue | 52.00 | pr. |
| 62-017551 | 62-63 | Fawn       | 52.00 | pr. |
| 64-017551 | 64    | Light Fawn | 52.00 | pr. |
| 64-017561 | 62-64 | Saddle     | 52.00 | pr. |



Fits 1965-1967 2-door rear.

Original grain vinyl wrapped arm rest pads, sold in pairs.

|          |       |             |       |     |
|----------|-------|-------------|-------|-----|
| 65-01760 | 65-67 | Black       | 52.00 | pr. |
| 65-01761 | 65-67 | Red         | 52.00 | pr. |
| 65-01762 | 65-67 | Light Blue  | 52.00 | pr. |
| 65-01763 | 67    | Gold        | 52.00 | pr. |
| 65-01764 | 65-66 | Aqua        | 52.00 | pr. |
| 65-01765 | 66-67 | Bright Blue | 52.00 | pr. |
| 65-01766 | 65-66 | Fawn        | 52.00 | pr. |
| 65-01767 | 65    | Saddle      | 52.00 | pr. |
| 65-01768 | 67    | Ivy Gold    | 52.00 | pr. |

Fits 1965-1967 4-door rear.

Original grain vinyl wrapped arm rest pads, sold in pairs.

|          |       |                |       |     |
|----------|-------|----------------|-------|-----|
| 65-01770 | 65-67 | Black          | 52.00 | pr. |
| 65-01777 | 65    | Saddle         | 52.00 | pr. |
| 65-01771 | 65-66 | Red            | 52.00 | pr. |
| 65-01772 | 65-66 | Aqua/Turquoise | 52.00 | pr. |
| 65-01773 | 65-67 | Light Blue     | 52.00 | pr. |
| 65-01775 | 65-66 | Fawn           | 52.00 | pr. |
| 65-01778 | 67    | Ivy Gold       | 52.00 | pr. |

## INTERIOR SCREW KITS



|          |       |                    |       |     |
|----------|-------|--------------------|-------|-----|
| 62-02425 | 62    | 2-door, 65 screws  | 22.00 | kit |
| 62-02426 | 62    | 4-door, 63 screws  | 22.00 | kit |
| 62-02427 | 62    | Conv, 84 screws    | 27.00 | kit |
| 63-02427 | 63    | Conv, 82 screws    | 24.00 | kit |
| 63-02425 | 63-65 | 2-door, 59 screws  | 18.00 | kit |
| 63-02426 | 63-65 | 4-door, 59 screws  | 20.00 | kit |
| 66-02425 | 66-67 | 2-door, 45 screws  | 14.00 | kit |
| 66-02426 | 66-67 | 4-door, 72 screws  | 23.00 | kit |
| 68-02425 | 68-70 | 2-door, 90 screws  | 14.00 | kit |
| 68-02426 | 68-70 | 4-door, 100 screws | 30.00 | kit |
| 71-02425 | 71-72 | 2-door, 90 screws  | 23.00 | kit |
| 71-02426 | 71-72 | 4-door, 103 screws | 32.00 | kit |
| 71-02427 | 73-74 | 2-door, 76 screws  | 27.00 | kit |
| 71-02428 | 73-74 | 4-door, 88 screws  | 32.00 | kit |

## CHROME SCREWS



|          |             |              |     |     |
|----------|-------------|--------------|-----|-----|
| 67-02450 | #8 x 3/4"   | with #6 head | .25 | ea. |
| 67-02451 | #8 x 3/4"   | with #8 head | .25 | ea. |
| 67-02452 | #8 x 1-1/4" | with #6 head | .25 | ea. |
| 67-02453 | #8 x 1-1/4" | with #8 head | .25 | ea. |
| 67-02454 | #8 x 1-1/2" | with #6 head | .25 | ea. |
| 67-02455 | #8 x 1-3/4" | with #6 head | .25 | ea. |

## WASHER HEAD CHROME SCREWS



|          |           |                   |     |     |
|----------|-----------|-------------------|-----|-----|
| 67-02458 | #8 x 5/8" | with small washer | .25 | ea. |
| 67-02459 | #8 x 3/4" | with large washer | .25 | ea. |

## BLACK TRIM SCREW



|          |           |              |     |     |
|----------|-----------|--------------|-----|-----|
| 67-02460 | #8 x 3/4" | with #6 head | .25 | ea. |
|----------|-----------|--------------|-----|-----|

## ROOF RAIL RETAINING SCREWS



|          |            |                    |     |     |
|----------|------------|--------------------|-----|-----|
| 67-02465 | #10 x 1/2" | with 1/2 flat head | .40 | ea. |
|----------|------------|--------------------|-----|-----|

## SEAT BELT BOLTS

|          |       |       |      |     |
|----------|-------|-------|------|-----|
| 64-01030 | 64-66 | Front | 6.00 | ea. |
| 64-01031 | 64-66 | Rear  | 6.00 | ea. |



|          |       |                                  |      |     |
|----------|-------|----------------------------------|------|-----|
| 67-02434 | 67-72 | Front                            | 6.00 | ea. |
| 67-02435 | 67-70 | Front inner, with shoulder belts | 6.00 | ea. |
| 67-02436 | 67-72 | Rear                             | 6.00 | ea. |



|          |       |   |       |     |
|----------|-------|---|-------|-----|
| 67-02437 | 67-72 | Front and rear set without shoulder belts | 40.00 | set |
| 67-02438 | 67-72 | Front and rear set with shoulder belts    | 40.00 | set |

## SEAT BELT ANCHOR PLATE



Universal fit, comes with 7/16"-20 threads, welds to floor.

|           |       |  |       |     |
|-----------|-------|--|-------|-----|
| 58-064198 | 62-66 |  | 21.00 | ea. |
|-----------|-------|--|-------|-----|

## UNIVERSAL PUSH BUTTON SEAT BELTS



74 inches long fully extended.

|          |       |            |       |     |
|----------|-------|------------|-------|-----|
| 67-02528 | 62-74 | Black      | 16.00 | ea. |
| 67-02529 | 62-74 | Light Gray | 16.00 | ea. |
| 67-02530 | 62-74 | Dark Gray  | 16.00 | ea. |
| 67-02531 | 62-74 | Tan        | 16.00 | ea. |
| 67-02532 | 62-74 | Med. blue  | 16.00 | ea. |
| 67-02533 | 62-74 | Maroon     | 16.00 | ea. |

\* The following items require additional shipping and handling.

# CHEVROLET NOVA PARTS



Car Shop Inc. 739 North Batavia Orange, California 92868

## UNIVERSAL FLIP BUCKLE SEAT BELTS



Replacement type, does 1 person.

74 inches long fully extended. *Includes hardware*

67-02503 62-65 black .....\$ 20.00 kit

60 inches long fully extended. *Includes hardware*

67-02504 62-65 black .....\$ 21.00 kit



74 inches long fully extended. *Hardware not included*

67-02506 62-65 Red .....\$ 27.00 ea.

67-02507 62-65 Turquoise .....\$ 27.00 ea.

67-02508 62-65 Light Blue .....\$ 27.00 ea.

67-02509 62-65 Medium Blue .....\$ 27.00 ea.

67-02510 62-65 Dark Blue .....\$ 27.00 ea.

67-02511 62-65 Drab Green .....\$ 27.00 ea.

67-02512 62-65 Dark Green .....\$ 27.00 ea.

67-02513 62-65 Gray .....\$ 27.00 ea.

67-02514 62-65 White .....\$ 27.00 ea.

67-02515 62-65 Tan .....\$ 27.00 ea.

67-02516 62-65 Silver .....\$ 27.00 ea.

60 inches long fully extended. *Hardware not included*

67-02517 62-65 Red .....\$ 27.00 ea.

67-02518 62-65 Turquoise .....\$ 27.00 ea.

67-02519 62-65 Light Blue .....\$ 27.00 ea.

67-02520 62-65 Medium Blue .....\$ 27.00 ea.

67-02521 62-65 Dark Blue .....\$ 27.00 ea.

67-02522 62-65 Drab Green .....\$ 27.00 ea.

67-02523 62-65 Dark Green .....\$ 27.00 ea.

67-02524 62-65 Gray .....\$ 27.00 ea.

67-02525 62-65 White .....\$ 27.00 ea.

67-02526 62-65 Tan .....\$ 27.00 ea.

67-02527 62-65 Silver .....\$ 27.00 ea.

## UNIVERSAL FLIP BUCKLE SEAT BELTS



Replacement type, does 1 person, *Hardware not included*

67-02505 62-65 Black with shoulder harness ..\$ 65.00 ea.

## SEAT BELT RETRACTORS



67-02538 Universal .....\$ 22.00 pr.

## SEAT BELT EMBLEMS



62-06414 62-63 .....\$ 12.00 pr.



64-06415 64 .....\$ 10.00 pr.



65-06416 65-66 Black, standard .....\$ 12.00 pr.



66-06417 65-66 Red, deluxe .....\$ 12.00 pr.



68-06417 68-72 .....\$ 10.00 pr.



Looks great on universal flip buckle seat belts.

67-02535 Round, Black with cross flags .....\$ 8.00 pr.

## ORIGINAL STYLE SEAT BELTS



Standard seat belts, black only.

66-06411 65-66 Front or rear .....\$ 138.00 ea.



Deluxe seat belts, black only, original for fullsize passenger cars.

66-064111 65-66 Front .....\$ 132.00 ea.

66-064112 65-66 rear .....\$ 108.00 ea.



Black only, replacement for some years.

68-06412 68-72 LH, front .....\$ 135.00 ea.

68-06413 68-72 RH, front .....\$ 135.00 ea.

## SEAT BELT BUCKLE COVER



For standard seat belts.

Includes buckle cover, push button, button spring & button emblem.

67-02501 67 Black, Fisher .....\$ 22.00 ea.

68-02502 68-72 Black, "GM" .....\$ 22.00 ea.



Includes buckle cover only.

67-025012 67-72 Black .....\$ 14.00 ea.

67-025013 67-72 Blue .....\$ 14.00 ea.

67-025014 67-72 Red .....\$ 14.00 ea.

69-025015 69-72 Green .....\$ 14.00 ea.

\* The following items require additional shipping and handling.

Fax Order 1-714-771-0407 • Toll Free 1-800-235-2470 • [www.TruckandCarShop.com](http://www.TruckandCarShop.com) • 2014 Catalog



# CHEVROLET NOVA PARTS

Car Shop Inc. 739 North Batavia Orange, California 92868

## SHOULDER BELT HARNESS PLASTIC COVER



New shoulder harness plastic cover that mounts at the end of the seat belt at the headliner, and covers the bolts at the headliner.

67-02540 68-72 black, coupe .....\$ 11.00 ea.

## SHOULDER HARNESS RETAINER



67-02539 68-72 .....\$ 8.00 pr.

## SPRAY ADHESIVE



Permatex all purpose spray adhesive.

67-026401 10.5 fl. oz. ....\$ 9.00 can

Permatex heavy duty headliner & carpet spray adhesive.

67-02640 16.75 fl. oz. ....\$ 15.00 can

3M Super trim adhesive, bonds heavyweight automotive materials.

67-026402 19 fl. oz. ....\$ 24.00 can

## CARPET KITS



## CARPET KITS



Our carpets come ready to install.

Features pre-installed jute backing, hole for dimmer switch and correct heel pads.

2-piece original design, Includes front and rear sections.

**MOLDED 80/20 LOOP CARPET**

|           |       |                   |                |     |
|-----------|-------|-------------------|----------------|-----|
| 62-02601+ | 62-67 | Black             | .....\$ 159.00 | kit |
| 62-02602+ | 62-67 | Red               | .....\$ 159.00 | kit |
| 62-02603+ | 62-67 | Light/Medium Blue | ...\$ 159.00   | kit |
| 62-02604+ | 62-64 | Dark Saddle       | .....\$ 159.00 | kit |
| 62-02605+ | 62-66 | Aqua/Turquoise    | ....\$ 159.00  | kit |
| 65-02606+ | 62-65 | Medium Saddle     | ....\$ 159.00  | kit |
| 62-02607+ | 62-64 | Fawn              | .....\$ 159.00 | kit |
| 65-02608+ | 65-66 | Fawn/Parchment    | ....\$ 159.00  | kit |
| 66-02609+ | 66-67 | Bright Blue       | .....\$ 159.00 | kit |
| 67-02610+ | 67    | Gold              | .....\$ 159.00 | kit |
| 67-02611+ | 67    | Ivy Gold          | .....\$ 159.00 | kit |
| 67-02612+ | 62-67 | Gun Metal Gray    | ....\$ 159.00  | kit |

|           |       |                      |                |     |
|-----------|-------|----------------------|----------------|-----|
| 68-02615+ | 68-74 | Black                | .....\$ 159.00 | kit |
| 68-02616+ | 68    | Ivy Gold             | .....\$ 159.00 | kit |
| 68-02617+ | 68-70 | Medium Blue          | .....\$ 159.00 | kit |
| 69-02618+ | 69    | Red                  | .....\$ 159.00 | kit |
| 69-02619+ | 69    | Bright Blue          | .....\$ 159.00 | kit |
| 69-02620+ | 69    | Light Moss Green     | ....\$ 159.00  | kit |
| 69-02621+ | 69-72 | Dark Green           | .....\$ 159.00 | kit |
| 70-02622+ | 70    | Gold                 | .....\$ 159.00 | kit |
| 70-02623+ | 70    | Medium Saddle        | ....\$ 159.00  | kit |
| 70-02624+ | 70    | Dark Blue            | .....\$ 159.00 | kit |
| 70-02625+ | 70-74 | Sandalwood/Parchment | ..\$ 159.00    | kit |
| 71-02626+ | 71    | Dark Brown/Saddle    | ...\$ 159.00   | kit |
| 68-02612+ | 68-74 | Gun Metal Gray       | ....\$ 159.00  | kit |

## FLOOR INSULATION (SOUND DEADENER)

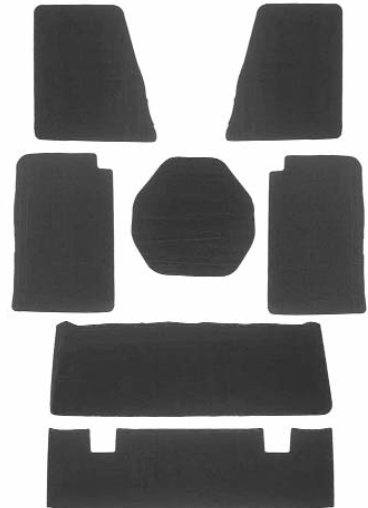

When replacing carpet, it's always a good idea to replace the floor insulation. Also helps deaden road noise.

|          |       |               |               |     |
|----------|-------|---------------|---------------|-----|
| 62-02634 | 62-67 | replacement   | .....\$ 44.00 | set |
| 68-02634 | 68-74 | replacement   | .....\$ 44.00 | set |
| 62-02636 | 62-67 | Original type | .....\$ 78.00 | set |
| 68-02636 | 68-74 | Original type | .....\$ 78.00 | set |

## HEAT SHIELD JUTE PADDING



Insulates against heat, cold and noise. 48" x 72" sheet.

67-02637 62-74 One sided .....\$ 22.00 ea.



Insulates against heat, cold and noise. 48" x 72" sheet.

67-02638 62-74 Two sided .....\$ 26.00 ea.

## JUTE PADDING

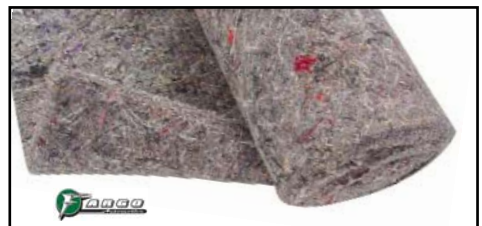

Padding only, no foil, as original.

67-02639 62-74 Cut to fit .....\$ 17.00 ea.



# CHEVROLET NOVA PARTS



Car Shop Inc. 739 North Batavia Orange, California 92868

## DOOR SILL PLATES



Fits 2-door hardtop or sedan.

- 62-02701 62-67 LH, 2-door ..... \$ 37.00 ea.
- 62-02702 62-67 RH, 2-door ..... \$ 37.00 ea.



- 62-02703 62-63 LH & RH, convertible ... \$ 130.00 pr.



Fits 4-door sedan or station wagon.

- 62-02704 62-67 LH & RH, 4 pieces ... \$ 174.00 set



Fits 2-door sedan.

- 68-02705 68-79 LH, 2-door ..... \$ 37.00 ea.
- 68-02706 68-79 RH, 2-door ..... \$ 37.00 ea.



Sill plate extensions, these pieces are installed on the rear end of the door sill plate, below the inner rear side panels.

- 68-02704 68-72 LH & RH ..... \$ 37.00 pr.



Stick on Body by Fisher tags.

- 67-02707 62-79 Fisher emblem only ... \$ 3.00 ea.



- 62-02708 62-79 Screw kit, 12 pcs. .... \$ 3.00 kit

## ORIGINAL STYLE FLOOR MATS



Includes 1-piece full front floor mat & 1-piece full rear floor mat.  
Features same color molded-in Chevrolet Bowtie logo.  
Fits cars without center consoles.

- 62-02718 62-64 Black ..... \$ 194.00 set
- 62-02719 62-64 Red ..... \$ 194.00 set
- 62-02720 62-64 Light Blue ..... \$ 194.00 set
- 62-02721 62-64 Medium Blue ..... \$ 194.00 set
- 62-02722 62-64 Dark Blue ..... \$ 194.00 set
- 62-02723 62-64 Dark Green ..... \$ 194.00 set
- 62-02724 62-64 Fawn ..... \$ 194.00 set

## BOW-TIE RUBBER FLOOR MATS



Original style accessory mats. set of 4.

Features white molded-in Chevrolet Bowtie logo.

- 61-04210 62-64 Black ..... \$ 179.00 set
- 61-04211 62-64 Blue ..... \$ 179.00 set
- 61-04212 62-64 Red ..... \$ 179.00 set
- 59-04213 62-64 Bright Red ..... \$ 179.00 set
- 59-04214 62-64 Gray ..... \$ 179.00 set
- 59-04215 62-64 Tan ..... \$ 179.00 set

## BOW-TIE RUBBER FLOOR MATS

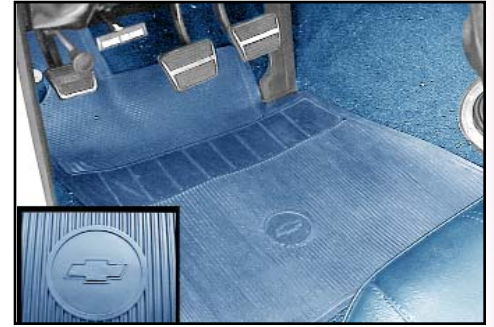

Original style accessory mats. set of 4.

Features same color molded-in Chevrolet Bowtie logo.

- 65-04213 65-66 Black ..... \$ 159.00 set
- 65-04214 65-66 Blue ..... \$ 159.00 set
- 65-04215 65-66 Red ..... \$ 159.00 set



Original style accessory mats. set of 4.

Features same color molded-in Chevrolet Bowtie logo.

- 67-02718 67-74 Black ..... \$ 132.00 set
- 67-02719 67-74 Red ..... \$ 132.00 set
- 67-02720 67-74 Gold ..... \$ 132.00 set
- 67-02721 67-74 Light Blue ..... \$ 132.00 set
- 68-02721 67-74 Medium Blue ..... \$ 132.00 set
- 68-02722 67-74 Ivy Gold ..... \$ 132.00 set
- 69-02723 67-74 Dark Blue ..... \$ 132.00 set
- 69-02724 67-74 Dark Green ..... \$ 132.00 set

+ The following items require additional shipping and handling.

Fax Order 1-714-771-0407 • Toll Free 1-800-235-2470 • [www.TruckandCarShop.com](http://www.TruckandCarShop.com) • 2014 Catalog



# CHEVROLET NOVA PARTS

Car Shop Inc. 739 North Batavia Orange, California 92868

## PACKAGE TRAY

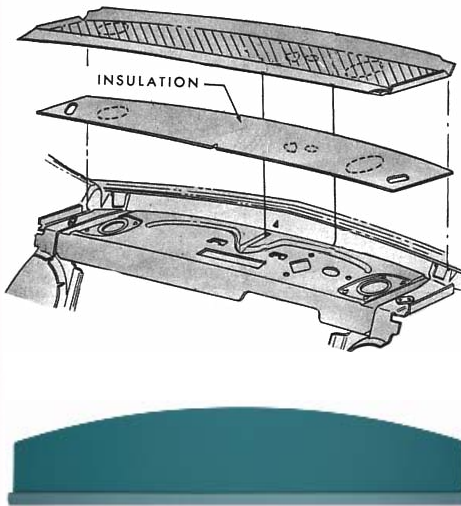

Die cut reproduction for a perfect fit. Includes color matched vinyl strip and foam underside

### 1962-65 Hardtop or Sedan

|           |       |            |              |
|-----------|-------|------------|--------------|
| 62-02818+ | 62-65 | Black      | \$ 20.00 ea. |
| 62-02819+ | 62    | Bright Red | \$ 20.00 ea. |
| 63-02820+ | 63-65 | Red        | \$ 20.00 ea. |
| 62-02821+ | 62-65 | Light Blue | \$ 20.00 ea. |
| 62-02822+ | 62-65 | Aqua       | \$ 20.00 ea. |
| 62-02823+ | 62-64 | Saddle     | \$ 20.00 ea. |
| 62-02824+ | 62-63 | Fawn       | \$ 20.00 ea. |
| 64-02825+ | 64    | Fawn       | \$ 20.00 ea. |
| 65-02826+ | 65    | Fawn       | \$ 20.00 ea. |
| 65-02827+ | 65    | Saddle     | \$ 20.00 ea. |

### 1966-67 Hardtop or Sedan

|           |       |                |              |
|-----------|-------|----------------|--------------|
| 66-02818+ | 66-67 | Black          | \$ 20.00 ea. |
| 66-02819+ | 66    | Aqua/Turquoise | \$ 20.00 ea. |
| 66-02820+ | 66    | Fawn           | \$ 20.00 ea. |
| 66-02821+ | 66-67 | Red            | \$ 20.00 ea. |
| 66-02822+ | 66-67 | Light Blue     | \$ 20.00 ea. |
| 66-02823+ | 66-67 | Bright Blue    | \$ 20.00 ea. |
| 66-02824+ | 67    | Gold           | \$ 20.00 ea. |
| 67-02825+ | 67    | Ivy Gold       | \$ 20.00 ea. |

### 1968-72 2-door Sedan

|           |       |             |              |
|-----------|-------|-------------|--------------|
| 68-02818+ | 68-72 | Black       | \$ 20.00 ea. |
| 68-02819+ | 68    | Blue        | \$ 20.00 ea. |
| 68-02820+ | 68    | Ivy Gold    | \$ 20.00 ea. |
| 69-02821+ | 69    | Red         | \$ 20.00 ea. |
| 69-02822+ | 69    | Light Green | \$ 20.00 ea. |
| 69-02823+ | 69-70 | Dark Green  | \$ 20.00 ea. |
| 69-02824+ | 69-70 | Light Blue  | \$ 20.00 ea. |
| 70-02825+ | 70    | Gold        | \$ 20.00 ea. |
| 70-02826+ | 70-71 | Sandalwood  | \$ 20.00 ea. |
| 71-02827+ | 71    | Dark Blue   | \$ 20.00 ea. |
| 71-02828+ | 71    | Dark Green  | \$ 20.00 ea. |
| 71-02829+ | 71    | Dark Saddle | \$ 20.00 ea. |
| 72-02830+ | 72    | Tan         | \$ 20.00 ea. |
| 72-02831+ | 72    | Dark Green  | \$ 20.00 ea. |
| 72-02832+ | 72    | Covert      | \$ 20.00 ea. |

## PACKAGE TRAY JUTE PADDING



Attaches to the underside of the package tray.

|          |       |              |
|----------|-------|--------------|
| 62-02837 | 62-65 | \$ 12.00 ea. |
| 66-02837 | 66-67 | \$ 12.00 ea. |
| 68-02837 | 68-72 | \$ 12.00 ea. |

## FIREWALL INSULATION PAD

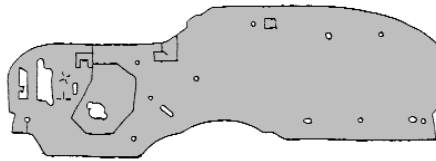

Pad fits under dash along the firewall. Includes all necessary grommets for easy installation.

|          |                   |              |
|----------|-------------------|--------------|
| 62-02839 | 62-67             | \$ 42.00 ea. |
| 67-02839 | 68-72 Without A/C | \$ 39.00 ea. |
| 67-02840 | 68-72 With A/C    | \$ 39.00 ea. |

## FIREWALL INSULATION PAD FASTENERS



|          |                            |             |
|----------|----------------------------|-------------|
| 67-02843 | 62-79 rubber type          | \$ 3.00 ea. |
| 67-02844 | 62-79 plastic replacements | \$ .65 ea.  |

## FIREWALL INSULATION PAD FASTENER TOOL



|           |                         |             |
|-----------|-------------------------|-------------|
| 67-028445 | 62-79 installation tool | \$ 8.00 ea. |
|-----------|-------------------------|-------------|

## CARPET FIREWALL GUARD



|          |       |              |
|----------|-------|--------------|
| 67-02845 | 68-72 | \$ 23.00 ea. |
|----------|-------|--------------|



|          |                 |             |
|----------|-----------------|-------------|
| 67-02846 | 67-68 Fasteners | \$ 3.50 pr. |
| 69-02846 | 69-72 Fasteners | \$ 3.50 pr. |

## TRUNK DIVIDER



This is the cardboard that separates the trunk area from the rear seat. Die-cut to fit perfectly.

|           |       |              |
|-----------|-------|--------------|
| 62-02730+ | 62-67 | \$ 18.00 ea. |
| 68-02730+ | 68-72 | \$ 18.00 ea. |

## TRUNK DIVIDER JUTE PADDING



|          |       |              |
|----------|-------|--------------|
| 62-02732 | 62-67 | \$ 13.00 ea. |
| 68-02732 | 68-72 | \$ 13.00 ea. |

## HEADLINER BOWS

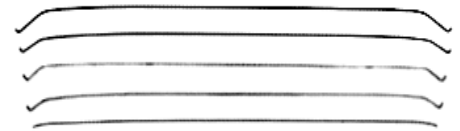

|          |                      |              |
|----------|----------------------|--------------|
| 62-02847 | 62-65 2-door hardtop | \$ 58.00 set |
| 66-02847 | 66-67 2-door hardtop | \$ 58.00 set |
| 62-02848 | 62-64 2-door sedan   | \$ 58.00 set |
| 65-02848 | 65 2-door sedan      | \$ 68.00 set |
| 66-02848 | 66-67 2-door sedan   | \$ 68.00 set |
| 68-02848 | 68-72 2-door sedan   | \$ 58.00 set |

## HEADLINER BOW & RETAINER KIT

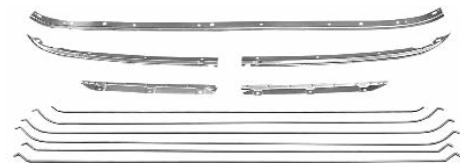

Includes outer retaining rails & bows.

|           |                      |               |
|-----------|----------------------|---------------|
| 66-028471 | 66-67 2-door hardtop | \$ 135.00 kit |
|-----------|----------------------|---------------|

## HEADLINER BOW CLIPS



|          |              |              |
|----------|--------------|--------------|
| 67-02849 | 67-71 4 pcs. | \$ 15.00 set |
|----------|--------------|--------------|

## HEADLINER INSTALLATION TOOL



|          |       |             |
|----------|-------|-------------|
| 67-02901 | 62-74 | \$ 8.00 ea. |
|----------|-------|-------------|

# CHEVROLET NOVA PARTS



Car Shop Inc. 739 North Batavia Orange, California 92868

## HEADLINERS

**CAR SHOP OFFERS  
THE HIGHEST QUALITY HEADLINERS!**  
• CORRECT MATERIAL •  
• BEST FIT! • BEST QUALITY! •



Our headliners are reproduced from the original factory patterns and are available in the correct factory colors and grains.

All 1962-72 headliners include sun visor & sail panel material.

### 1962-65 2-Door Hardtop Headliner

#### Basket weave vinyl

|          |       |            |       |          |     |
|----------|-------|------------|-------|----------|-----|
| 62-02861 | 62-65 | Black      | ..... | \$ 85.00 | ea. |
| 62-02862 | 62-65 | White      | ..... | \$ 95.00 | ea. |
| 62-02863 | 62-65 | Fawn       | ..... | \$ 99.00 | ea. |
| 62-02864 | 62-65 | Aqua       | ..... | \$ 99.00 | ea. |
| 62-02865 | 62-65 | Red        | ..... | \$ 99.00 | ea. |
| 62-02866 | 62-65 | Light Blue | ..... | \$ 99.00 | ea. |

### 1966 2-Door Hardtop Headliner

#### Basket weave vinyl

|          |    |            |       |          |     |
|----------|----|------------|-------|----------|-----|
| 66-02861 | 66 | Black      | ..... | \$ 85.00 | ea. |
| 66-02862 | 66 | Fawn       | ..... | \$ 99.00 | ea. |
| 66-02863 | 66 | Aqua       | ..... | \$ 99.00 | ea. |
| 66-02864 | 66 | Red        | ..... | \$ 99.00 | ea. |
| 66-02865 | 66 | Light Blue | ..... | \$ 99.00 | ea. |



### 1967 2-Door Hardtop Headliner

#### Impala leatherette vinyl, (line-dot)

|          |    |                      |       |          |     |
|----------|----|----------------------|-------|----------|-----|
| 67-02871 | 67 | Black                | ..... | \$ 85.00 | ea. |
| 67-02872 | 67 | Red                  | ..... | \$ 99.00 | ea. |
| 67-02873 | 67 | Bright Metallic Blue | ...   | \$ 99.00 | ea. |
| 67-02874 | 67 | Gold                 | ..... | \$ 99.00 | ea. |

## HEADLINERS



**CHECK OUR  
Quality!**



Our headliners are reproduced from the original factory patterns and are available in the correct factory colors and grains.

All 1962-72 headliners include sun visor & sail panel material.

### 1962-64 2 or 4-Door Sedan Headliner

#### Basket weave vinyl

|          |       |            |       |           |     |
|----------|-------|------------|-------|-----------|-----|
| 62-02871 | 62-64 | Black      | ..... | \$ 105.00 | ea. |
| 62-02872 | 62-64 | White      | ..... | \$ 115.00 | ea. |
| 62-02873 | 62-64 | Fawn       | ..... | \$ 119.00 | ea. |
| 62-02874 | 62-64 | Aqua       | ..... | \$ 119.00 | ea. |
| 62-02875 | 62-64 | Red        | ..... | \$ 119.00 | ea. |
| 62-02876 | 62-64 | Light Blue | ..... | \$ 119.00 | ea. |

### 1965 2 or 4-Door Sedan Headliner

#### Basket weave vinyl

|          |    |            |       |           |     |
|----------|----|------------|-------|-----------|-----|
| 65-02871 | 65 | Black      | ..... | \$ 105.00 | ea. |
| 65-02872 | 65 | Fawn       | ..... | \$ 119.00 | ea. |
| 65-02873 | 65 | Aqua       | ..... | \$ 119.00 | ea. |
| 65-02874 | 65 | Red        | ..... | \$ 119.00 | ea. |
| 65-02875 | 65 | Light Blue | ..... | \$ 119.00 | ea. |

### 1966 2 or 4-Door Sedan Headliner

#### Basket weave vinyl

|          |    |                |       |           |     |
|----------|----|----------------|-------|-----------|-----|
| 66-02871 | 66 | Black          | ..... | \$ 105.00 | ea. |
| 66-02872 | 66 | Fawn           | ..... | \$ 119.00 | ea. |
| 66-02873 | 66 | Aqua/Turquoise | ..... | \$ 119.00 | ea. |
| 66-02874 | 66 | Red            | ..... | \$ 119.00 | ea. |
| 66-02875 | 66 | Light Blue     | ..... | \$ 119.00 | ea. |



### 1967 2 or 4-Door Sedan Headliner

#### Impala leatherette vinyl, (line-dot)

|          |    |                      |       |           |     |
|----------|----|----------------------|-------|-----------|-----|
| 67-02881 | 67 | Black                | ..... | \$ 105.00 | ea. |
| 67-02882 | 67 | Red                  | ..... | \$ 119.00 | ea. |
| 67-02883 | 67 | Bright Metallic Blue | ...   | \$ 119.00 | ea. |
| 67-02884 | 67 | Gold                 | ..... | \$ 119.00 | ea. |
| 67-02885 | 67 | Blue                 | ..... | \$ 119.00 | ea. |

## HEADLINERS

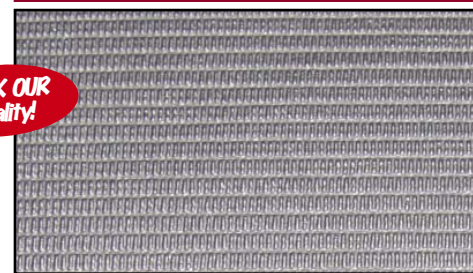

Our headliners are reproduced from the original factory patterns and are available in all of the correct factory colors and grains.

All 1962-72 headliners include sun visor & sail panel material.

### 1968-69 2-Door Sedan Headliner

#### Bedford rib vinyl

|          |       |             |       |          |     |
|----------|-------|-------------|-------|----------|-----|
| 68-02888 | 68-69 | Black       | ..... | \$ 95.00 | ea. |
| 68-02889 | 68    | Ivy Gold    | ..... | \$ 95.00 | ea. |
| 69-02890 | 69    | Light Green | ..... | \$ 99.00 | ea. |
| 69-02891 | 69    | Dark Green  | ..... | \$ 95.00 | ea. |



### 1968-72 2-Door Sedan Headliner

#### Premier non-perforated vinyl

|          |       |             |       |          |     |
|----------|-------|-------------|-------|----------|-----|
| 68-02893 | 68-72 | Black       | ..... | \$ 85.00 | ea. |
| 68-02894 | 68-72 | Medium Blue | ..... | \$ 99.00 | ea. |
| 68-02895 | 68-72 | Dark Blue   | ..... | \$ 99.00 | ea. |
| 68-02896 | 68-72 | Dark Green  | ..... | \$ 99.00 | ea. |
| 68-02897 | 68-72 | Sandalwood  | ..... | \$ 99.00 | ea. |



### 1968-72 2-Door Sedan Headliner

#### Premier Perforated vinyl

|          |       |              |       |          |     |
|----------|-------|--------------|-------|----------|-----|
| 68-02901 | 68-72 | Black        | ..... | \$ 95.00 | ea. |
| 68-02902 | 68-72 | Red          | ..... | \$ 95.00 | ea. |
| 68-02903 | 68-72 | Medium Blue  | ..... | \$ 95.00 | ea. |
| 68-02904 | 68-72 | Dark Green   | ..... | \$ 95.00 | ea. |
| 68-02905 | 68-72 | Light Saddle | ..... | \$ 95.00 | ea. |
| 68-02906 | 68-72 | Dark Saddle  | ..... | \$ 95.00 | ea. |
| 68-02907 | 68-72 | Sandalwood   | ..... | \$ 95.00 | ea. |

\* The following items require additional shipping and handling.

Fax Order 1-714-771-0407 • Toll Free 1-800-235-2470 • [www.TruckandCarShop.com](http://www.TruckandCarShop.com) • 2014 Catalog



# CHEVROLET NOVA PARTS

Car Shop Inc. 739 North Batavia Orange, California 92868

## HEADLINERS

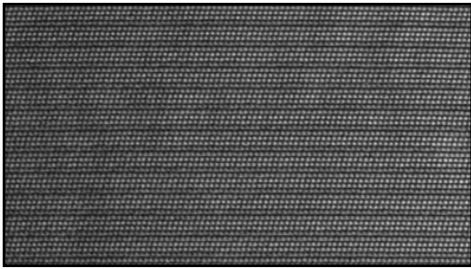

### 1968-72 4-Door Sedan Headliner

Premier non-perforated vinyl

|          |       |             |       |           |     |
|----------|-------|-------------|-------|-----------|-----|
| 68-02911 | 68-72 | Black       | ..... | \$ 105.00 | ea. |
| 68-02912 | 68-72 | Medium Blue | ..... | \$ 119.00 | ea. |
| 68-02913 | 68-72 | Dark Blue   | ..... | \$ 119.00 | ea. |
| 68-02914 | 68-72 | Dark Green  | ..... | \$ 119.00 | ea. |
| 68-02915 | 68-72 | Sandalwood  | ..... | \$ 119.00 | ea. |

### 1962-67 4-Door Station Wagon Headliner

Basket weave vinyl

|          |       |            |       |           |     |
|----------|-------|------------|-------|-----------|-----|
| 62-02921 | 62-67 | Black      | ..... | \$ 185.00 | ea. |
| 62-02922 | 62-67 | White      | ..... | \$ 195.00 | ea. |
| 62-02923 | 62-67 | Fawn       | ..... | \$ 199.00 | ea. |
| 62-02924 | 62-67 | Aqua       | ..... | \$ 199.00 | ea. |
| 62-02925 | 62-67 | Red        | ..... | \$ 199.00 | ea. |
| 62-02926 | 62-67 | Light Blue | ..... | \$ 199.00 | ea. |

## HEADLINER WINDLACE TRIM, FRONT



### FRONT

Seals headliner into place above the inside mirror, black only.

|           |       |             |       |          |     |
|-----------|-------|-------------|-------|----------|-----|
| 62-02927  | 62-67 | made in USA | ..... | \$ 47.00 | pr. |
| 62-029271 | 62-67 | import      | ..... | \$ 32.00 | pr. |



|          |       |       |       |          |     |
|----------|-------|-------|-------|----------|-----|
| 68-02927 | 68-72 | ..... | ..... | \$ 42.00 | ea. |
|----------|-------|-------|-------|----------|-----|



### REAR

This plastic strip seals the headliner from the rear glass, black only.

|          |       |                |       |          |     |
|----------|-------|----------------|-------|----------|-----|
| 62-02929 | 62-65 | Hardtop, 5-pcs | ..... | \$ 69.00 | set |
|----------|-------|----------------|-------|----------|-----|



|          |       |              |       |          |     |
|----------|-------|--------------|-------|----------|-----|
| 62-02930 | 62-64 | Sedan, 5-pcs | ..... | \$ 99.00 | set |
| 65-02931 | 65    | Sedan, 5-pcs | ..... | \$ 99.00 | set |
| 66-02932 | 66-67 | Sedan, 3-pcs | ..... | \$ 98.00 | set |



|          |       |                     |    |          |     |
|----------|-------|---------------------|----|----------|-----|
| 66-02933 | 66-67 | Hardtop, 7-pcs, USA | .. | \$ 84.00 | set |
|----------|-------|---------------------|----|----------|-----|

## REAR HEADLINER WINDLACE CORNERS



|          |       |                |       |          |     |
|----------|-------|----------------|-------|----------|-----|
| 62-02934 | 62-65 | Hardtop, upper | ..... | \$ 30.00 | pr. |
|----------|-------|----------------|-------|----------|-----|



|          |       |                |       |          |     |
|----------|-------|----------------|-------|----------|-----|
| 66-02934 | 66-67 | Hardtop, upper | ..... | \$ 21.00 | pr. |
|----------|-------|----------------|-------|----------|-----|



|          |       |                |       |          |     |
|----------|-------|----------------|-------|----------|-----|
| 66-02935 | 66-67 | Hardtop, lower | ..... | \$ 31.00 | pr. |
|----------|-------|----------------|-------|----------|-----|



|          |       |       |       |          |     |
|----------|-------|-------|-------|----------|-----|
| 68-02936 | 68-72 | lower | ..... | \$ 28.00 | pr. |
|----------|-------|-------|-------|----------|-----|

## INTERIOR REVEAL MOLDING CLIPS



|          |       |                      |       |          |     |
|----------|-------|----------------------|-------|----------|-----|
| 62-02950 | 62-65 | upper side, 8 pieces | ..    | \$ 19.00 | kit |
| 62-02951 | 62-65 | upper side, each     | ..... | \$ 2.50  | ea. |



|          |       |                       |       |          |     |
|----------|-------|-----------------------|-------|----------|-----|
| 66-02952 | 66-67 | upper side, 10 pieces | ..    | \$ 24.00 | kit |
| 66-02953 | 66-67 | upper side, each      | ..... | \$ 2.50  | ea. |

## SAIL PANEL BOARDS



|          |       |       |       |          |     |
|----------|-------|-------|-------|----------|-----|
| 66-02937 | 66-67 | ..... | ..... | \$ 25.00 | pr. |
| 68-02937 | 68-72 | ..... | ..... | \$ 25.00 | pr. |

## SAIL PANEL C-PILLAR FILLER BOARD



C-pillar filler boards install behind the sail panels.

|          |       |       |       |          |     |
|----------|-------|-------|-------|----------|-----|
| 68-02938 | 68-72 | ..... | ..... | \$ 24.00 | pr. |
|----------|-------|-------|-------|----------|-----|

## SUN VISOR SUPPORT HARDWARE



|          |       |                     |    |        |     |
|----------|-------|---------------------|----|--------|-----|
| 67-03027 | 62-73 | support clamp screw | .. | \$ .50 | ea. |
|----------|-------|---------------------|----|--------|-----|



|           |       |   |       |         |     |
|-----------|-------|---|-------|---------|-----|
| 67-030281 | 65-73 | support to roof & clamp screw, coupe, 4 pc. set | ..... | \$ 3.00 | set |
|-----------|-------|---|-------|---------|-----|

## SUN VISOR SUPPORT



|          |       |                  |       |          |     |
|----------|-------|------------------|-------|----------|-----|
| 62-03022 | 62-64 | exc. convertible | ..... | \$ 53.00 | pr. |
|----------|-------|------------------|-------|----------|-----|



|          |       |       |       |          |     |
|----------|-------|-------|-------|----------|-----|
| 67-03022 | 65-73 | coupe | ..... | \$ 15.00 | ea. |
|----------|-------|-------|-------|----------|-----|



|          |       |       |       |          |     |
|----------|-------|-------|-------|----------|-----|
| 70-03022 | 74-78 | ..... | ..... | \$ 49.00 | pr. |
|----------|-------|-------|-------|----------|-----|

## SUN VISOR BUSHING TIP KIT



Replacement kit Includes 2 tips and 2 nylon insert sleeves.

|           |       |                       |       |         |     |
|-----------|-------|-----------------------|-------|---------|-----|
| 67-03029  | 62-73 | .....                 | ..... | \$ 4.00 | kit |
| 67-030291 | 62-63 | rubber tip only, gray | ..    | \$ 1.50 | ea. |

+ The following items require additional shipping and handling.

# CHEVROLET NOVA PARTS



Car Shop Inc. 739 North Batavia Orange, California 92868

## SUN VISORS

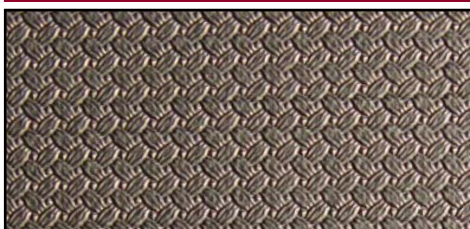

1962-64 Hardtop & 2 or 4-Door Sedan

1962-64 Station Wagon

Basket weave vinyl

|          |       |            |                   |
|----------|-------|------------|-------------------|
| 62-03001 | 62-64 | Black      | .....\$ 98.00 pr. |
| 62-03002 | 62-64 | White      | .....\$ 98.00 pr. |
| 62-03003 | 62-64 | Fawn       | .....\$ 98.00 pr. |
| 62-03004 | 62-64 | Aqua       | .....\$ 98.00 pr. |
| 62-03005 | 62-64 | Red        | .....\$ 98.00 pr. |
| 62-03006 | 62-64 | Light Blue | .....\$ 98.00 pr. |

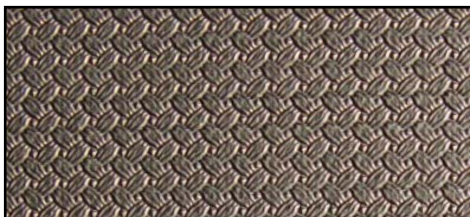

1965-66 Hardtop & 2 or 4-Door Sedan

1965-67 Station Wagon

Basket weave vinyl

|          |       |                |                   |
|----------|-------|----------------|-------------------|
| 65-03001 | 65-67 | Black          | .....\$ 98.00 pr. |
| 65-03002 | 65-67 | White          | .....\$ 98.00 pr. |
| 65-03003 | 65-67 | Fawn           | .....\$ 98.00 pr. |
| 65-03004 | 65-67 | Aqua/Turquoise | .....\$ 98.00 pr. |
| 65-03005 | 65-67 | Red            | .....\$ 98.00 pr. |
| 65-03006 | 65-67 | Light Blue     | .....\$ 98.00 pr. |



1967 Hardtop & 2 or 4-Door Sedan

Impala leatherette vinyl, (line-dot)

|          |    |                      |                   |
|----------|----|----------------------|-------------------|
| 67-03001 | 67 | Black                | .....\$ 98.00 pr. |
| 67-03002 | 67 | Red                  | .....\$ 98.00 pr. |
| 67-03003 | 67 | Bright Metallic Blue | .....\$ 98.00 pr. |
| 67-03004 | 67 | Gold                 | .....\$ 98.00 pr. |
| 67-03005 | 67 | Blue                 | .....\$ 98.00 pr. |

## SUN VISORS



1968-69 2-Door Sedan

Bedford rib vinyl

|          |       |             |                    |
|----------|-------|-------------|--------------------|
| 68-03001 | 68-69 | Black       | .....\$ 98.00 pr.  |
| 68-03002 | 68    | Ivy Gold    | .....\$ 98.00 pr.  |
| 69-03003 | 69    | Light Green | .....\$ 104.00 pr. |
| 69-03004 | 69    | Dark Green  | .....\$ 98.00 pr.  |



1968-72 2-Door Sedan

Premier non-perforated vinyl

|          |       |             |                   |
|----------|-------|-------------|-------------------|
| 68-03005 | 68-72 | Black       | .....\$ 98.00 pr. |
| 68-03006 | 68-72 | Medium Blue | .....\$ 98.00 pr. |
| 68-03007 | 68-72 | Dark Blue   | .....\$ 98.00 pr. |
| 68-03008 | 68-72 | Dark Green  | .....\$ 98.00 pr. |
| 68-03009 | 68-72 | Sandalwood  | .....\$ 98.00 pr. |



1968-72 2-Door Sedan

Premier Perforated vinyl

|          |       |              |                   |
|----------|-------|--------------|-------------------|
| 68-03011 | 68-72 | Black        | .....\$ 94.00 pr. |
| 68-03012 | 68-72 | Red          | .....\$ 94.00 pr. |
| 68-03013 | 68-72 | Medium Blue  | .....\$ 94.00 pr. |
| 68-03014 | 68-72 | Dark Green   | .....\$ 94.00 pr. |
| 68-03015 | 68-72 | Light Saddle | .....\$ 94.00 pr. |
| 68-03016 | 68-72 | Dark Saddle  | .....\$ 94.00 pr. |
| 68-03017 | 68-72 | Sandalwood   | .....\$ 94.00 pr. |

## SUN VISORS



CONVERTIBLE

|          |       |            |                   |
|----------|-------|------------|-------------------|
| 62-03018 | 62-63 | black      | .....\$ 94.00 pr. |
| 62-03019 | 62    | Bright Red | .....\$ 94.00 pr. |
| 63-03019 | 63    | Red        | .....\$ 94.00 pr. |
| 62-03020 | 62-63 | Light Blue | .....\$ 94.00 pr. |
| 62-03021 | 62-63 | Aqua       | .....\$ 94.00 pr. |
| 62-03025 | 62-63 | White      | .....\$ 94.00 pr. |
| 62-03023 | 62-63 | Saddle     | .....\$ 94.00 pr. |
| 62-03024 | 62-63 | Fawn       | .....\$ 94.00 pr. |

## INTERIOR COAT HOOKS



|          |       |                  |                  |
|----------|-------|------------------|------------------|
| 58-06218 | 58-66 | Coat hooks       | .....\$ 8.00 pr. |
| 58-06219 | 58-66 | Coat hook screws | .....\$ .50 pr.  |



|                                      |       |       |                  |
|--------------------------------------|-------|-------|------------------|
| Replacement coat hooks, thick style. |       |       |                  |
| 67-03030                             | 67-74 | black | .....\$ 8.00 ea. |



|                                     |       |            |                  |
|-------------------------------------|-------|------------|------------------|
| Replacement coat hooks, thin style. |       |            |                  |
| 67-030301                           | 67-74 | black      | .....\$ 6.00 ea. |
| 67-030302                           | 67-74 | dark blue  | .....\$ 6.00 ea. |
| 67-030304                           | 67-74 | red/maroon | .....\$ 6.00 ea. |
| 67-030305                           | 67-74 | tan        | .....\$ 6.00 ea. |
| 67-030306                           | 67-74 | white      | .....\$ 6.00 ea. |
| 67-030307                           | 67-74 | green      | .....\$ 6.00 ea. |

\* The following items require additional shipping and handling.

Fax Order 1-714-771-0407 • Toll Free 1-800-235-2470 • [www.TruckandCarShop.com](http://www.TruckandCarShop.com) • 2014 Catalog



# CHEVROLET NOVA PARTS

Car Shop Inc. 739 North Batavia Orange, California 92868

## INTERIOR DOME LIGHT ASSEMBLY



Includes the base, lens, bulb, clips and wire leads

67-030303 62-70 .....\$ 26.00 kit



70-030303 71-79 .....\$ 26.00 kit

## INTERIOR DOME LIGHT LENSES



67-03032 62-70 .....\$ 3.00 ea.



70-03101 71-79 .....\$ 7.00 ea.

## INTERIOR DOME LIGHT BASES



67-03103 62-70 .....\$ 8.00 ea.



70-03105 71-79 .....\$ 13.00 ea.

## DOMELIGHT BASE SCREW KIT



67-031051 62-79 2 pieces .....\$ 1.50 pr.

## DOMELIGHT BULB



67-03108 62-79 .....\$ 2.00 ea.

## DOMELIGHT HARNESS



With separate door jamb switch connection.

65-03109 65-67 .....\$ 18.00 ea.

Plugs in to rear light harness.

65-03110 65-67 .....\$ 18.00 ea.

69-03110 69 2-door .....\$ 17.00 ea.

70-03110 70-72 2-door .....\$ 29.00 ea.

## UNDER DASH COURTESY LIGHT BRACKETS



67-03112 62-72 2 per car .....\$ 6.00 ea.

## UNDER DASH COURTESY LIGHT HARNESS



62-03113 62-63 .....\$ 25.00 ea.

## DOMELIGHT DOOR JAMB SWITCH



67-03117 62-74 Single round terminal ...\$ 4.00 ea.

67-03118 62-74 Double flat terminal ...\$ 7.00 ea.

67-031181 62-74 Double flat terminal with plastic tip .....\$ 12.00 ea.

67-03119 62-74 Single flat terminal ...\$ 7.00 ea.

## AUTOMATIC SHIFTER LINKAGE



**For original shifter and transmission applications.**

Includes original style shifter arm, linkage rod & swivel.

68-03202 68-74 TH350/TH400 .....\$ 46.00 ea.

## CONVERSION SHIFTER LINKAGE



**For transmission conversions.**

Includes conversion rod & swivel.

For use with powerglide shifter and TH350 or TH400 trans.

65-03204 65-67 .....\$ 43.00 ea.

For use with powerglide shifter and TH700R4, 4L60 trans.

65-03205 65-67 .....\$ 43.00 ea.



Includes conversion rod, swivel and lever.

For use with powerglide shifter and TH350 or TH400 trans.

68-03205 68-72 .....\$ 67.00 ea.

## SHIFTER LEVER SWIVEL KIT



Includes swivel, 2 lock nuts, retainer clip and grommet.

67-03201 65-72 .....\$ 11.00 kit

## AUTOMATIC TRANSMISSION SHIFTER ARM



Shift arm on the side of the transmission.

67-03207 65-67 With P.G. ....\$ 35.00 ea.

# CHEVROLET NOVA PARTS



Car Shop Inc. 739 North Batavia Orange, California 92868

## AUTOMATIC TRANSMISSION SHIFTER ARM

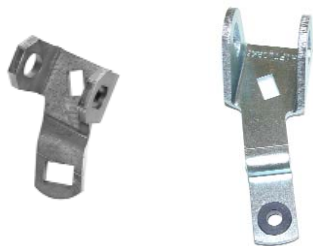

For use with shift cable & floor shifter.

69-03208 68-72 TH350/TH400 .....\$ 23.00 ea.

For use with shift linkage & floor shifter.

68-03208 68-72 TH350/TH400 .....\$ 26.00 ea.

## STEERING COLUMN LOCK ROD ASSEMBLY



This is the linkage that goes from the steering column arm on the bottom of the steering column to the shaft assembly that pivots on frame in the engine compartment. Allows the steering column to lock the transmission and the reverse lights to function. For use with floor shift (automatic or manual), or column shift automatic.

69-03230 69-72 S/B .....\$ 94.00 kit

69-03231 69-72 spring only .....\$ 4.00 ea.

69-03232 69-72 plastic washer .....\$ 4.00 ea.

## SHIFTER DETENT CONVERSION KIT

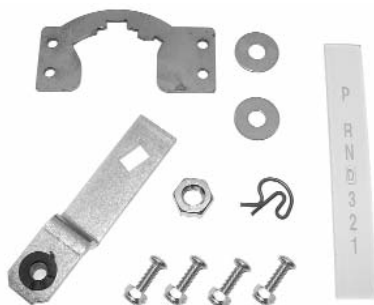

Converts Powerglide shifter to a TH350, 400 or 700R4 shifter.

65-03209 65-67 TH350, TH400 .....\$ 60.00 kit

65-03210 65-67 TH700R4, 4L60 .....\$ 60.00 kit

67-03209 68-72 TH350, TH400 .....\$ 59.00 kit

67-03210 68-72 TH700R4, 4L60 .....\$ 59.00 kit

## SHIFTER CABLE INSTALLATION KIT



Use when swapping out a Powerglide transmission for a TH350 or TH400 & installing a cable type console shifter.

68-03212 65-72 With console shifter ...\$ 40.00 kit

## SHIFTER CABLE PIN



68-03213 .....\$ 8.00 ea.

## AUTOMATIC SHIFTER CABLES



Use when swapping out a Powerglide transmission for a TH350 or TH400 & installing a cable type console shifter.

68-03214 65-72 "GM" .....\$ 93.00 ea.

68-03215 65-72 reproduction .....\$ 37.00 ea.

## UPPER KICKDOWN LINKAGE



Includes swivel and rod.

67-03219 67-72 2-BBL .....\$ 27.00 ea.

67-03220 67-72 4-BBL .....\$ 29.00 ea.

## LOWER KICKDOWN LINKAGE



Includes 2 threaded ball swivels and rod.

67-03221 64-72 Lower linkage .....\$ 22.00 ea.

## TH350 KICKDOWN CABLE



Kickdown cable

67-033011 67-74 reproduction .....\$ 25.00 ea.

67-03301 67-74 GM replacement .....\$ 47.00 ea.

## TH350 KICKDOWN CABLE BRACKET



67-03302 67-74 SB .....\$ 12.00 ea.

## TRANSMISSION KICKDOWN SOLENOID



67-033025 67-74 TH400 .....\$ 21.00 ea.

## TH400 KICKDOWN SWITCH BRACKET



68-03303 68-69 396/325 hp .....\$ 26.00 ea.

## KICKDOWN CABLE KIT



Stainless steel braided. Great for TH conversions

67-033045 TH350 .....\$ 39.00 ea.

67-033046 TH700R4 .....\$ 41.00 ea.

## TH400 ELECTRONIC KICKDOWN KIT



Cable operated electronic kickdown kit. Great for TH400 conversions.

67-03304 TH400 .....\$ 107.00 ea.



Cable mounting bracket for electronic Kickdown kit # 67-03304

67-033041 TH400 .....\$ 36.00 ea.

+ The following items require additional shipping and handling.

Fax Order 1-714-771-0407 • Toll Free 1-800-235-2470 • [www.TruckandCarShop.com](http://www.TruckandCarShop.com) • 2014 Catalog



# CHEVROLET NOVA PARTS

Car Shop Inc. 739 North Batavia Orange, California 92868

## COLUMN SHIFT ROD SWIVEL BOLT ASSEMBLY



58-045161 62-65 .....\$ 19.00 ea.

## GEAR SHIFT ROD SWIVEL BOLT



58-04516 62-67 .....\$ 7.00 ea.

## SWIVEL BOLT CUPPED WASHER RETAINER



58-045165 62-67 .....\$ 4.00 ea.

## COLUMN SHIFT CONVERSION LINKAGE KIT



For use when converting column shift 2-speed to column shift 3 or 4 speed.

67-03305 .....\$ 49.00 kit

## COLUMN TO TRANSMISSION SHIFT ROD



69-03307 68-70 With TH350/TH400 ...\$ 21.00 ea.

## COLUMN SHIFT LEVER KNOB



61-04512 62-66 .....\$ 14.00 ea.



71-03308 68-72 .....\$ 7.00 ea.

## COLUMN SHIFT INDICATOR HOUSING



64-02943 62-65 Chrome .....\$ 8.00 ea.

## COLUMN SHIFT INDICATOR LENS



64-02940 62-65 Powerglide .....\$ 6.00 ea.  
64-02941 62-65 TH350, TH400 .....\$ 22.00 ea.  
64-02942 62-65 TH700R4, 4L60 .....\$ 22.00 ea.



Automatic trans column shift indicator lens conversion. These are clear plastic lenses that will replace the powerglide indicator.

66-03340 66 TH350, TH400 .....\$ 22.00 ea.  
66-03341 66 overdrive .....\$ 22.00 ea.



67-03340 67 TH350, TH400 .....\$ 22.00 ea.  
67-03341 67 overdrive .....\$ 22.00 ea.

## COLUMN SHIFT LENS CONVERSION



Automatic trans column shift indicator lens conversion. Adhesive backed adaptors. Black with white letters.

68-03340 68-74 TH350, TH400 .....\$ 22.00 ea.  
68-03341 68-74 overdrive .....\$ 22.00 ea.

## AUTOMATIC SHIFTER HANDLE



Chrome shifter handle with black inner release button.

64-02402 65-67 .....\$ 58.00 ea.

## AUTO TRANS FLOOR SHIFT LEVER BUTTON



64-04526 62-67 .....\$ 14.00 ea.



67-03309 68-72 .....\$ 14.00 ea.



This spring must be used under the shifter release button for proper operation of shifter.

65-03310 65-72 button spring .....\$ 5.00 ea.

## AUTO TRANS FLOOR SHIFT LEVER PARTS



Shifter handle plastic (Delrin) bushings.

68-03330 68-72 .....\$ 16.00 pr.



Shifter handle neutral safety switch and back-up light actuator lever.

68-03331 68-72 .....\$ 16.00 ea.



Shifter handle bottom spring.

For handle with set screw spring retainer.

68-03332 68-72 .....\$ 5.00 ea.

For handle with cotter pin spring retainer.

68-03333 68-72 .....\$ 5.00 ea.



Shifter handle washer set.

68-03334 68-72 .....\$ 7.00 pr.



Shifter handle inner Flexi-Rod.

This is a new Flexi-Rod shift actuator that will replace the original GM stamped spring-steel actuator.

68-03335 68-72 .....\$ 59.00 ea.



# CHEVROLET NOVA PARTS



Car Shop Inc. 739 North Batavia Orange, California 92868

## REPLACEMENT AUTOMATIC SHIFTER ASSEMBLIES



Replacement shifter assembly, works with TH350, TH400, TH700R4 & 4L60 conversions, Includes neutral safety switch, cable not included.

63-03312 63-64 ..... \$ 295.00 kit



Replacement shifter assembly, works with TH350, TH400, TH700R4 & 4L60 conversions, Includes neutral safety switch & cable.

65-03312 65-67 ..... \$ 369.00 kit



Replacement shifter assembly, works with TH350, TH400, TH700R4 & 4L60 conversions, Includes neutral safety switch & linkage.

67-03312 68-72 ..... \$ 369.00 kit

## NEUTRAL SAFETY SWITCH PIVOT



70-03325 70-74 With 4-speed trans. ... \$ 13.00 ea.

## NEUTRAL SAFETY SWITCH



Replaces GM #1993696.

65-048092 65-67 PG, console shift ..... \$ 48.00 ea.

Replaces GM #1993321.

65-048091 65-67 TH400, console shift ... \$ 48.00 ea.



With console shifter, replaces GM #3900503.

67-03317 68-69 With P.G. trans. .... \$ 38.00 ea.

With console shifter, replaces GM #3909591.

67-03318 68-74 With TH350, TH400 ... \$ 38.00 ea.

With console shifter, for TH700R4 conversions.

67-033181 68-74 With TH700R4 ..... \$ 44.00 ea.



With column shift automatic, replaces GM #1993320 & 1993659.

58-048101 62-66 with column shift PG ... \$ 9.00 ea.

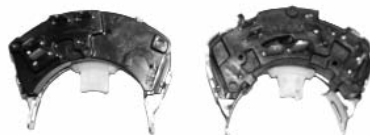

With column shift automatic.

67-03320 67-68 ..... \$ 26.00 ea.

69-03321 69-72 ..... \$ 20.00 ea.



With manual transmission, replaces GM #19933494.

69-033211 69 ..... \$ 54.00 ea.



With manual transmission, replaces GM #3983965.

70-033211 70-74 ..... \$ 42.00 ea.

## BACK-UP LAMP SWITCH



With 4 speed manual transmission, replaces GM #1998728.

59-04813 62 ..... \$ 52.00 ea.

With 4 speed manual transmission, replaces GM #1997929.

63-04814 63 ..... \$ 52.00 ea.

With 4 speed manual transmission, replaces GM #1993661.

64-04815 64 ..... \$ 52.00 ea.

With 4 speed manual transmission, replaces GM #1993307.

65-04816 65-67 ..... \$ 52.00 ea.

With manual transmission, replaces GM #1993413.

67-03401 68 Switch ..... \$ 52.00 ea.



69-03401 69-72 Switch ..... \$ 38.00 ea.

## BACK-UP LAMP SWITCH EXTENSION HARNESS



Switch to rear body connector.

62-03402 62 auto trans  
63 all trans, w/o ggs ..... \$ 16.00 ea.

62-03403 62 manual trans ..... \$ 16.00 ea.

64-03402 64-65 auto trans ..... \$ 16.00 ea.

66-03402 66 auto trans ..... \$ 16.00 ea.

Switch to rear body connector extension harness.

63-03403 63 manual trans ..... \$ 21.00 ea.

Fuse panel to rear body connector.

64-03403 64-67 manual trans ..... \$ 21.00 ea.



67-03402 68 manual trans ..... \$ 22.00 ea.

\* The following items require additional shipping and handling.

Fax Order 1-714-771-0407 • Toll Free 1-800-235-2470 • [www.TruckandCarShop.com](http://www.TruckandCarShop.com) • 2014 Catalog



# CHEVROLET NOVA PARTS

Car Shop Inc. 739 North Batavia Orange, California 92868

## BACK-UP/NEUTRAL SAFETY SWITCH ROD CLIP



3/32 size.  
67-034025 62-70 4 pieces .....\$ 2.50 set

## NEUTRAL SAFETY SWITCH LINKAGE ROD



With 3 or 4-speed manual transmission.  
69-03404 69-70 .....\$ 16.00 ea.

## BACK-UP LAMP SWITCH BRACKET



This is the bracket that mounts to the side of the transmission.  
67-03405 64-68 with 4-speed .....\$ 19.00 ea.

## BACK-UP LAMP SWITCH MOUNTING KIT

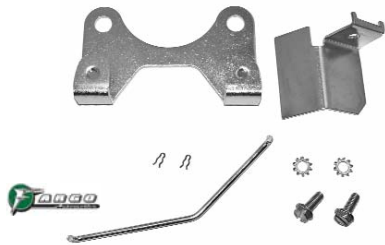
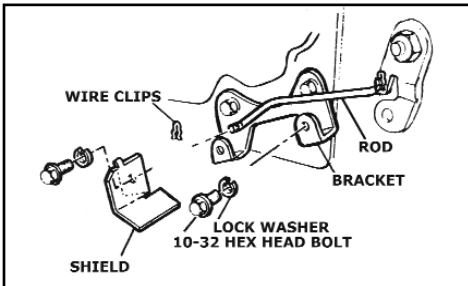

Includes: 1 bracket, 1 rod with 2 clips, 1 shield and 2 mounting bolts.  
67-034021 64-68 with 4-speed .....\$ 38.00 kit

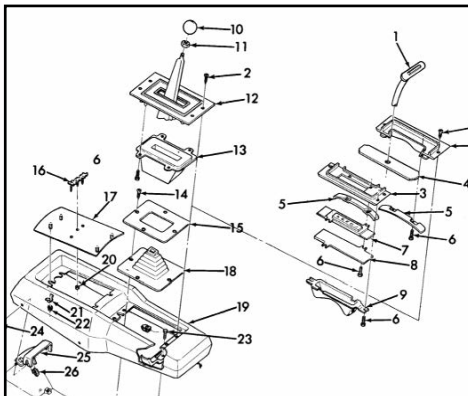

## CENTER SHIFT PLATE ASSEMBLY



Black & chrome, includes shift lens & slider.  
66-03406 66-67 with auto trans .....\$ 83.00 ea.



Chrome with black painted details, includes slider.  
66-03407 66-67 with 4-speed .....\$ 96.00 ea.

## CENTER SHIFT PLATES



Black and chrome.  
67-03406 68-74 With auto trans .....\$ 44.00 ea.



Black and chrome.  
67-03407 68-74 With manual trans .....\$ 45.00 ea.

## CONSOLE SHIFT SLIDER RETAINER



67-03517 68-74 .....\$ 8.00 pr.

## CONSOLE SHIFT HANDLE SLIDER



64-02416 65-67 with auto trans .....\$ 5.00 ea.  
67-03513 68-74 with auto trans .....\$ 5.00 ea.

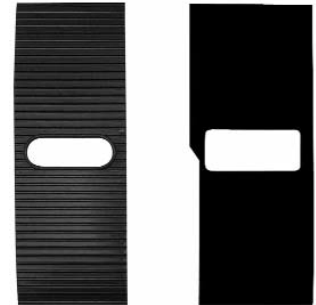

Plastic slider that fits around the shifter handle rod.  
65-03514 65-67 with manual trans .....\$ 18.00 ea.  
67-03514 68-74 with manual trans .....\$ 5.00 ea.

## SHIFT INDICATOR LENS



Plastic indicator lens with lettering that fits in your console. Perfect fit to replace your cracked or faded original.  
66-03601 66-67 Powerglide, USA .....\$ 26.00 ea.  
66-03602 66-67 Powerglide, IMPORT .....\$ 19.00 ea.  
66-03603 66-67 TH350 or TH400 .....\$ 13.00 ea.  
66-03604 66-67 700R-4, 4L60 .....\$ 13.00 ea.



Plastic indicator lens with lettering that fits in your console. Perfect fit to replace your cracked or faded original.  
Accurate reproduction lens with correct size and shade **green** print.  
67-03601 68-70 Powerglide .....\$ 6.00 ea.  
67-03602 68-70 TH350 or TH400 .....\$ 6.00 ea.  
Accurate reproduction lens with correct size and shade **blue** print.  
71-03601 71-74 Powerglide .....\$ 10.00 ea.  
71-03602 71-74 TH350 or TH400 .....\$ 10.00 ea.  
For TH700R-4 conversions.  
67-03603 68-74 700R-4 .....\$ 11.00 ea.

# CHEVROLET NOVA PARTS



Car Shop Inc. 739 North Batavia Orange, California 92868

## SHIFT INDICATOR LENS BACKING PLATE



67-03607 68-74 .....\$ 8.00 ea.

## SHIFT INDICATOR LAMP MOUNTING PLATE



67-03609 68-74 .....\$ 11.00 ea.

## AUTOMATIC SHIFTER RUBBER BOOT



Turbo-hydramatic with console.

67-036105 68-74 .....\$ 21.00 ea.

## 4-SPEED SHIFTER HANDLE SEAL



Upper shifter handle seal, with console, fits under plastic slider.

67-03611 68-74 with manual trans ....\$ 7.00 ea.

## SHIFTER BOOTS & SEALS



63-03613 63-64 Automatic floor shifter upper console seal ....\$ 26.00 ea.



63-03614 63 4-speed with bench, &  
63-64 SS, A/T, floor shift ....\$ 29.00 ea.

## 4-SPEED SHIFTER BOOTS



4-speed with or without console.

64-03614 64-67 4-speed .....\$ 20.00 ea.



68-03614 67-68 without console .....\$ 29.00 ea.



67-03614 68-72 with console .....\$ 18.00 ea.

## FLOOR SHIFT HOLE REINFORCEMENT RING



Stamped steel ring reinforces shifter hole in floor, for mounting A/T shifter or 4 speed shift boot retainer. Ring welds to bottom side of floor.

67-036182 68-72 .....\$ 20.00 ea.

## 4-SPEED SHIFT BOOT RETAINER



4-speed with or without console.

64-03618 64-67 Black .....\$ 16.00 ea.

64-03619 64-67 Chrome .....\$ 19.00 ea.

## 4-SPEED SHIFT BOOT RETAINER



68-03618 68-72 without console, 2 pcs . . \$ 38.00 pr.



67-03619 68-72 with console .....\$ 13.00 ea.

## FLOOR SHIFT HUMPH



62-03625 62-67 4-speed .....\$ 39.00 ea.



62-03626 62-67 automatic .....\$ 46.00 ea.



68-03625 68-72 4-speed with console . . \$ 70.00 ea.

+ The following items require additional shipping and handling.

Fax Order 1-714-771-0407 • Toll Free 1-800-235-2470 • [www.TruckandCarShop.com](http://www.TruckandCarShop.com) • 2014 Catalog



# CHEVROLET NOVA PARTS

Car Shop Inc. 739 North Batavia Orange, California 92868

## SHIFTER BALLS

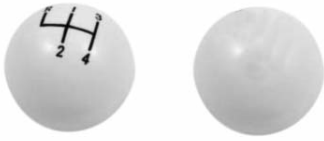

58-04522 63-64 4 speed, white . . . . . \$ 8.00 ea.  
62-04523 63-64 "SS" automatic, white . . . \$ 7.00 ea.

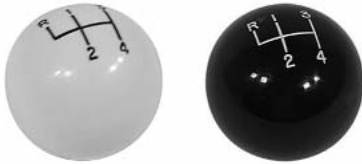

Features the same 4-speed pattern as the original.  
64-02702 65-67 White ball, 1/2" . . . . . \$ 31.00 ea.  
68-03709 68-72 White ball, 5/16" . . . . . \$ 19.00 ea.  
68-03710 White ball, 3/8" . . . . . \$ 19.00 ea.

Features the same 4-speed pattern as the original.  
68-03711 68-72 Black ball, 5/16" . . . . . \$ 19.00 ea.  
68-03712 Black ball, 3/8" . . . . . \$ 19.00 ea.



64-02701 65-67 Chrome ball, 1/2" . . . . . \$ 15.00 ea.  
68-03713 68-72 Chrome ball 5/16" . . . . . \$ 18.00 ea.  
68-03714 Chrome ball 3/8" . . . . . \$ 19.00 ea.

## 4-SPEED SHIFTER HANDLE MOUNTING STUDS



65-02630 65-67 . . . . . \$ 6.00 pr.

## 4-SPEED SHIFTER HANDLE



Features the same 4-speed pattern as the original.  
64-02710 65-67 With buckets, 1/2" . . . . . \$ 92.00 ea.  
64-02709 65-67 With bench seat, 1/2" . . . \$ 92.00 ea.

## 4-SPEED SHIFTER MECHANISM



64-02714 65-67 . . . . . \$ 155.00 pr.

## 4-SPEED SHIFTER ASSEMBLY



Includes chrome shift lever, shifter mechanism and shift linkage.  
67-03716 68-72 . . . . . \$ 279.00 set

## HURST COMPETITION PLUS 4-SPEED SHIFTER



Shifter assembly, Includes: Mechanism handle & knob  
Fits Muncie 451 transmission  
67-03717 68 with or without console . . \$ 325.00 set



Install kit  
Includes: Mounting plate, linkage, levers & hardware.  
Fits Muncie 451 transmission  
67-03719 68 . . . . . \$ 179.00 set

## 4-SPEED SHIFTER STABILIZER KIT



For use with original style shifter.  
67-03715 68-72 . . . . . \$ 42.00 kit

## 4-SPEED REVERSE LOCK OUT RODS



With stamped numerals.  
69-03806 69-70 Upper, all . . . . . \$ 22.00 ea.



With stamped numerals.  
69-03807 69-72 Lower, SB . . . . . \$ 24.00 ea.  
69-038071 69-72 Lower, BB . . . . . \$ 24.00 ea.

Without stamped numerals.  
69-03808 69-72 Upper & lower, SB . . . . \$ 39.00 pr.

## 4-SPEED REVERSE LOCK OUT LINKAGE KITS



Replacement kit: bellcrank, upper and lower rods without stamped #'s  
69-03809 69-72 SB . . . . . \$ 75.00 kit

Exact reproduction kit: Includes fully assembled bellcrank assembly, upper and lower rods (with stamped numerals) and necessary hardware. Heat treated for hardness as originals. Fits Muncie 4-spd.  
69-038091 69-72 SB . . . . . \$ 104.00 kit  
69-038092 69-72 BB . . . . . \$ 104.00 kit

## 4-SPEED REVERSE LOCK BELLCRANK



Features the correct stampings with all factory markings, gray phosphate plated. Includes bellcrank assembly, upper rod bushing, swivel, cup retainer, nut and washer.  
69-038095 69-72 SB . . . . . \$ 58.00 ea.

## 4-SPEED SHIFT RODS



For use with original shifters only.  
64-02716 65-67 . . . . . \$ 70.00 set

# CHEVROLET NOVA PARTS



Car Shop Inc. 739 North Batavia Orange, California 92868

## 4-SPEED SHIFT RODS



For use with original shifters only.

67-03811 68-72 With muncie . . . . . \$ 149.00 set

## 4-SPEED MUNCIE SHIFT LEVERS



For use with original shifters only.

67-038115 68-72 3 pieces . . . . . \$ 46.00 set

## CONSOLE ASSEMBLY



Each console assembly includes: Assembled console shell with bracing, console top plate, shift plate assembly with slider & SS front emblem.

66-03830+ 66-67 Auto, PG . . . . . \$ 469.00 kit



66-03832+ 66-67 4-speed . . . . . \$ 469.00 kit



## CONSOLE BASE



Console base only, black.

66-03815+ 66-67 4-speed . . . . . \$ 199.00 ea.



Console base only, black.

66-03816+ 66-67 Auto . . . . . \$ 199.00 ea.



Superior reproduction of original console from correct material (not thermoplastic as others) with correct OE stamped steel bracing. New tooling for 2013.

66-03817+ 68-72 black . . . . . \$ 149.00 ea.

## CONSOLE TOP PLATE



Console top plate only, die cast as original.

66-03817 66-67 4-speed . . . . . \$ 205.00 ea.



Console top plate only, die cast as original.

66-03818 66-67 Auto . . . . . \$ 205.00 ea.

## CONSOLE MOUNTING BRACKETS



Steel brackets that hold the console to the floor, with hardware.

66-03823 66-67 4-speed, 3 pieces . . . . \$ 38.00 set



Steel brackets that hold the console to the floor, with hardware.

66-03824 66-67 Auto, 2 pieces . . . . . \$ 31.00 set



Steel bracket that hold the front of the console to the floor.

68-03825 68-74 . . . . . \$ 15.00 ea.

## CONSOLE FORWARD PANEL



68-03900 68-74 black . . . . . \$ 24.00 ea.

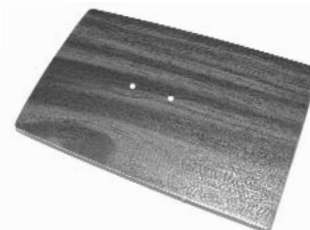

68-03901 68-74 Walnut . . . . . \$ 16.00 ea.

68-03902 69-74 Rosewood . . . . . \$ 16.00 ea.

## CONSOLE FORWARD PANEL EMBLEM



66-03905 66-67 SS . . . . . \$ 24.00 ea.



68-03905 68-74 . . . . . \$ 11.00 ea.

+ The following items require additional shipping and handling.



# CHEVROLET NOVA PARTS

Car Shop Inc. 739 North Batavia Orange, California 92868

## CONSOLE GAUGES



Nova gauges were originally black, Camaro gauges were silver.

- 68-04017 68-74 Amp gauge, black . . . \$ 57.00 ea.
- 68-04019 68-74 Temp gauge, black . . . \$ 57.00 ea.
- 68-04016 68-74 Amp gauge, silver . . . \$ 55.00 ea.
- 68-04018 68-74 Temp gauge, silver . . . \$ 55.00 ea.



- 68-04021 68-74 Fuel gauge, black . . . \$ 57.00 ea.
- 68-04023 68-74 Oil gauge, black . . . \$ 57.00 ea.
- 68-04020 68-74 Fuel gauge, silver . . . \$ 55.00 ea.
- 68-04022 68-74 Oil gauge, silver . . . \$ 55.00 ea.

## CONSOLE VOLT GAUGE



Non original volt meter. Some LS conversion wiring harnesses are made for volt meters not Amp gauge. Matches original gauges perfectly. Some drilling required to install, template included.

- 68-040171 68-74 Volt gauge . . . \$ 78.00 ea.

## CONSOLE GAUGE FACE RIVETS



- 68-040151 68-74 10 pieces . . . \$ 4.00 kit

## GAUGE RESISTORS



For use with original gauges.

- 67-04101 68-74 Fuel or amp gauge  
84 OHM pink . . . . . \$ 15.00 ea.
- 67-04102 68-74 Temp gauge  
86 OHM orange . . . . . \$ 15.00 ea.

## CUSTOM CONSOLE GAUGE COVER



Hole opening is 2-1/8" works with all 2-1/16" inch round gauges.

- 68-04030 68-74 black . . . . . \$ 38.00 ea.
- 68-04031 68-74 black carbon fiber . . . \$ 43.00 ea.

## CONSOLE GAUGE COVER



Features hot stamped chrome edging on both side edges and each surrounding lens opening as original.

Injection molded console gauge base in correct green plastic.

- 68-04106 68-70 . . . . . \$ 39.00 ea.

Injection molded console gauge base in correct blue plastic for Nova.

- 68-041061 68-74 . . . . . \$ 39.00 ea.

Driver quality, all black, no chrome trim.

- 68-04107 68-74 black . . . . . \$ 30.00 ea.

## CONSOLE GAUGE BASE



Injection molded console gauge base in correct blue plastic for Nova.

- 68-041081 68-74 Base . . . . . \$ 22.00 ea.

Injection molded console gauge base in light green plastic.

- 68-04108 68-74 Base . . . . . \$ 21.00 ea.

## CONSOLE GAUGE SET



Original for Camaro, features silver faced gauges.

- 68-04110 68-74 silver . . . . . \$ 368.00 set



Show Quality, Features correct blue components & white lettering. Superior reproduction in appearance. Correct installation hardware included, assembled in the USA.

- 68-041102 68-74 black . . . . . \$ 389.00 set

Driver Quality, Features light green components & lettering.

- 68-041103 68-74 black . . . . . \$ 348.00 set

## CONSOLE GAUGE HARDWARE KIT

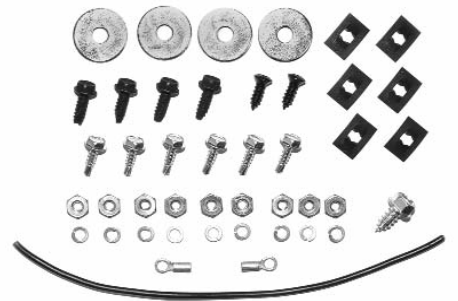

- 68-04112 68-74 . . . . . \$ 11.00 kit

## CONSOLE GAUGE CONNECTOR KIT

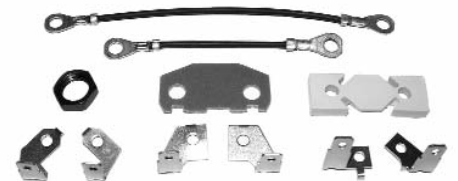

Our kit contains original style connectors and ground straps.

- 68-04113 68-74 . . . . . \$ 28.00 kit

+ The following items require additional shipping and handling.

# CHEVROLET NOVA PARTS



Car Shop Inc. 739 North Batavia Orange, California 92868

## CONSOLE SCREW KIT



65-04114 65-67 16 screws .....\$ 6.50 kit

68-04115 68-72 38 screws .....\$ 9.50 kit

## CONSOLE/SHIFTER TO FLOOR MOUNTING HARDWARE



Correct 5/16"-18 rivet nuts, bolts and washers for console installation. These nuts can also be used to mount automatic floor shifters.

68-04114 6 pieces .....\$ 10.00 kit

## CONSOLE GAUGE MOUNTING BRACKETS



68-04119 68-74 6 pieces .....\$ 10.00 kit

## CONSOLE GAUGE MOUNTING PLATES

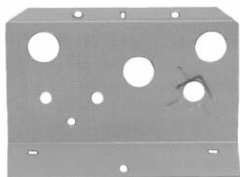

Die stamped steel with correct green coated finish.  
68-04201 68-70 Fuel / Oil, front plate ..\$ 14.00 ea.

Die stamped steel with correct blue coated finish.  
68-042011 68-74 Fuel / Oil, front plate ..\$ 15.00 ea.

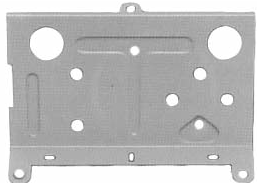

Die stamped steel with correct green coated finish.  
68-04202 68-70 Batt / Temp, rear plate ..\$ 14.00 ea.

Die stamped steel with correct blue coated finish.  
68-042021 68-74 Batt / Temp, rear plate ..\$ 15.00 ea.

## CONSOLE GAUGE BEZELS



Injection molded in light green plastic with light green text.  
68-04203 68-70 Fuel / Oil, front bezel ..\$ 15.00 ea.

Injection molded in correct blue plastic with white text.  
71-04203 68-74 Fuel / Oil, front bezel ..\$ 19.00 ea.

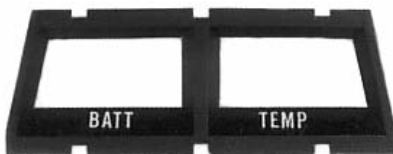

Injection molded in light green plastic with light green text.  
68-04204 68-70 Batt / Temp, rear bezel ..\$ 15.00 ea.

Injection molded in correct blue plastic with white text.  
71-04204 68-74 Batt / Temp, rear bezel ..\$ 19.00 ea.

## CONSOLE GAUGE LENSES



68-04206 68-74 2 required .....\$ 5.00 ea.

## CONSOLE GAUGE LIGHT BULBS



68-04208 68-74 .....\$ 1.50 ea.

## OIL GAUGE BLOCK FITTING



Replacement type.  
67-04210 68-76 .....\$ 3.00 ea.



Exact brass reproduction of original with correct logo stampings. Includes tall engine block coupling fitting, oil line compression bushing and nut., the tall fitting raises the attaching point above intake manifold for easier installation.

68-04210 68-76 SB .....\$ 16.00 ea.

• CAR SHOP • BEST QUALITY! •  
• BEST PRICE! •

## OIL GAUGE OIL LINE



Includes black plastic line and 2 female fittings.  
67-04209 68-74 .....\$ 7.00 ea.

## GLOVE BOXES

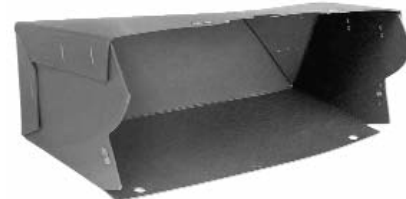

62-04211 62-65 .....\$ 15.00 ea.  
66-04211 66-67 .....\$ 15.00 ea.  
68-04211 68 Without A/C .....\$ 15.00 ea.  
68-04212 68 With A/C .....\$ 15.00 ea.

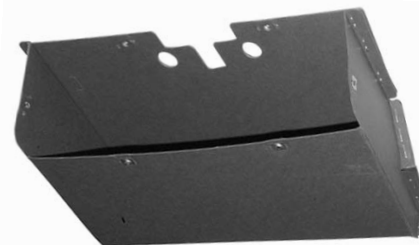

69-04211 69-79 Without A/C .....\$ 15.00 ea.  
69-04212 69-79 With A/C .....\$ 15.00 ea.

## GLOVE BOX SCREW KIT



67-04217 62-67 replacement silver screws .....\$ 2.00 kit



67-04218 68-79 correct black screws ..\$ 4.00 kit

## GLOVE BOX RUBBER BUMPERS



67-04219 62-79 Door bumpers .....\$ 1.50 pr.



67-06404 62-79 Arm bumper .....\$ 2.00 ea.

† The following items require additional shipping and handling.

Fax Order 1-714-771-0407 • Toll Free 1-800-235-2470 • www.TruckandCarShop.com • 2014 Catalog



# CHEVROLET NOVA PARTS

Car Shop Inc. 739 North Batavia Orange, California 92868

## GLOVE BOX DOOR ASSEMBLY



66-04218 66-67 with hinge .....\$ 120.00 ea.



69-042181 69-74 with hinge .....\$ 77.00 ea.

## GLOVE BOX DOOR SCREW KIT



66-04230 66-67 3 pieces .....\$ 4.50 kit



69-04230 69-74 3 pieces .....\$ 3.00 kit

## GLOVE BOX CATCH



62-04220 62-65 .....\$ 7.50 ea.



66-04220 66-67 .....\$ 7.50 ea.



69-04221 69-79 .....\$ 7.00 ea.

## GLOVE BOX LIGHT KIT



67-04222 62-72 .....\$ 10.00 kit

## MOLDED DASH PAD OUTER SHELL



The shell is heat resistant ABS plastic. The shell installs over your original dash pad. This is a low cost alternative to dash pad replacement. Black

65-04301+ 65 .....\$ 115.00 ea.

66-04302+ 66 .....\$ 115.00 ea.



69-04305+ 69-74 With A/C .....\$ 99.00 ea.

69-04306+ 69-74 Without A/C .....\$ 99.00 ea.

## DASH PADS



63-04320+ 63-64 Black .....\$ 196.00 ea.



66-04320+ 66 Black .....\$ 196.00 ea.



67-04320+ 67 Black .....\$ 196.00 ea.



Without air conditioning.

68-04320+ 68 Black .....\$ 206.00 ea.



With air conditioning.

68-04330+ 68 Black .....\$ 206.00 ea.



Without air conditioning.

69-04330+ 69-74 Black .....\$ 230.00 ea.



With air conditioning.

69-04334+ 69-74 Black .....\$ 230.00 ea.

## DASH PAD FASTENER KIT



69-043401 69-74 22 pieces .....\$ 13.00 kit

## DASH INSTRUMENT BEZELS



63-04430 63-65 .....\$ 88.00 ea.



66-04430 66 .....\$ 93.00 ea.



67-04430 67 .....\$ 93.00 ea.



Without A/C, without seatbelt warning.

69-044301 69-74 .....\$ 299.00 ea.

Without A/C, with seatbelt warning.

69-044302 69-74 .....\$ 299.00 ea.



With A/C, without seatbelt warning.

69-044303 69-74 .....\$ 299.00 ea.

With A/C, with seatbelt warning.

69-044304 69-74 .....\$ 299.00 ea.

+ The following items require additional shipping and handling.



# CHEVROLET NOVA PARTS



Car Shop Inc. 739 North Batavia Orange, California 92868

## INSTRUMENT CLUSTER TO DASH FASTENER KIT



69-04441 69-74 16 pieces .....\$ 8.50 kit

## RADIO DASH BEZEL



This is the face plate that fits around the radio.

66-04515 66-67 .....\$ 23.00 ea.

## GLOVE BOX DOOR EMBLEM



63-04501 63-64 Nova - Chevy II .....\$ 39.00 ea.



63-04502 63-64 Nova SS .....\$ 39.00 ea.



65-04503 65 Nova - Chevy II .....\$ 39.00 ea.



66-04503 66 Super Sport .....\$ 31.00 ea.

## DASH EMBLEM



67-04504 67 Nova - Chevy II .....\$ 39.00 ea.



67-04504 67 Super Sport .....\$ 38.00 ea.

## DASH PANEL GRAB HANDLE



Original for 1969 Camaro, mounts above glove box.

69-04505 69-72 black .....\$ 32.00 ea.



69-04506 69-72 chrome bezels .....\$ 20.00 pr.

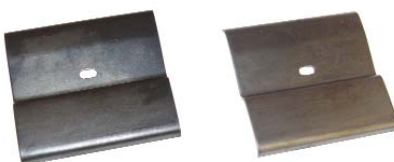

69-04507 69-72 backing plates .....\$ 24.00 pr.

## DASH PANEL TRIM SET



65-04508 65 Standard .....\$ 344.00 set



65-04509 65 SS .....\$ 345.00 set

## LOWER STEERING COLUMN COVER PANEL



69-04512 69-74 .....\$ 30.00 ea.

## STEERING COLUMN COVER TO DASH SCREW KIT



69-045125 69-74 .....\$ 4.00 kit

## DASH ASH TRAYS



69-045181 69-74 with black face .....\$ 59.00 ea.



69-04518 69-79 ash tray insert .....\$ 18.00 ea.

## ASH TRAY BUMPERS



69-04525 69-74 .....\$ 3.00 pr.

## DASH GAUGE LENS



63-04601 63-65 .....\$ 45.00 ea.



66-04601 66-67 .....\$ 45.00 ea.



68-04601 68-76 .....\$ 62.00 ea.

**Showroom hours:**  
**TUESDAY - FRIDAY: 8:30AM to 4:30PM**  
**SATURDAY: 8:30AM to 3:30PM**  
**Phone order desk hours:**  
**MONDAY - FRIDAY: 8:30AM to 4:30PM**

\* The following items require additional shipping and handling.

Fax Order 1-714-771-0407 • Toll Free 1-800-235-2470 • [www.TruckandCarShop.com](http://www.TruckandCarShop.com) • 2014 Catalog



# CHEVROLET NOVA PARTS

Car Shop Inc. 739 North Batavia Orange, California 92868

## DASH BEZEL SET



66-04630 66-67 chrome, 4 pieces . . . . \$ 60.00 set

## IGNITION SWITCH BEZEL



62-04613 62-64 chrome . . . . . \$ 9.00 ea.

## IGNITION SWITCH BEZEL NUT



62-05727 62-65 chrome, 3-slots . . . . . \$ 6.00 ea.



65-04617 65 chrome, 4-slots . . . . . \$ 28.00 ea.

66-04617 66 chrome, 4-slots . . . . . \$ 28.00 ea.



67-10209 67 chrome, 3-slots . . . . . \$ 7.00 ea.



68-10209 68 stainless steel . . . . . \$ 38.00 ea.

## DASH KNOB SET



69-04620 69-70 With mono radio . . . . . \$ 28.00 set

69-04621 69-70 With stereo radio . . . . . \$ 28.00 set

## CIGARETTE LIGHTER ASSEMBLY



61-05817 62-63 Rochester type . . . . . \$ 23.00 ea.



64-05818 64 Casco type, with housing & retainer . . . . . \$ 19.00 ea.



64-05819 64 Rochester type . . . . . \$ 23.00 ea.



65-05820 65-66 Rochester type . . . . . \$ 23.00 ea.



67-04701 67 . . . . . \$ 19.00 ea.

67-04702 67 Knob only . . . . . \$ 12.00 ea.



68-03020 68 complete . . . . . \$ 20.00 ea.



69-04703 69-74 . . . . . \$ 20.00 ea.

69-04704 69-74 Knob only . . . . . \$ 12.50 ea.



70-04704 75-78 . . . . . \$ 30.00 ea.

## CIGARETTE LIGHTER HEATING ELEMENT



Rochester style heating element.  
67-04705 62-78 . . . . . \$ 10.00 ea.

## CIGARETTE LIGHTER HOUSING



Rochester style housing.  
67-04706 62-69 . . . . . \$ 17.00 ea.  
70-04706 70-78 . . . . . \$ 20.00 ea.

## CIGARETTE LIGHTER RETAINER



Rochester style housing.  
67-04707 62-78 . . . . . \$ 6.00 ea.



70-04707 70-81 with light housing . . . . . \$ 19.00 ea.

## TISSUE DISPENSER



63-05905 63 . . . . . \$ 72.00 ea.



64-05906 64-65 . . . . . \$ 72.00 ea.



67-04708 66-67 . . . . . \$ 72.00 ea.

\* The following items require additional shipping and handling.

# CHEVROLET NOVA PARTS



Car Shop Inc. 739 North Batavia Orange, California 92868

## TISSUE DISPENSER REFILL



67-04709 63-67 Tissue refill ..... \$ 4.00 ea.

## SPEEDOMETER CABLE GROMMET



67-04719 68-74 ..... \$ 5.50 ea.

## SPEEDOMETER CABLE ADAPTER TO TRANS BOLT



67-04730 62-79 ..... \$ 2.00 ea.

## SPEEDOMETER GEAR



67-04720 62-79 18 teeth, brown ..... \$ 10.00 ea.  
 67-04721 62-79 20 teeth, blue ..... \$ 10.00 ea.  
 67-04722 62-79 21 teeth, red ..... \$ 10.00 ea.  
 67-04723 62-79 22 teeth, green ..... \$ 10.00 ea.  
 67-04724 62-79 24 teeth, yellow ..... \$ 10.00 ea.  
 67-04725 62-79 25 teeth, white ..... \$ 10.00 ea.

## SPEEDOMETER CABLES



67-04713 62-68 Plastic Coated Housing  
 68 inch ..... \$ 13.00 ea.

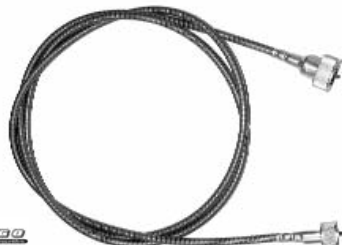

67-04714 62-68 Steel Spiral Housing  
 70 inch ..... \$ 15.00 ea.

## SPEEDOMETER CABLES



### Correct length reproductions, with grommet

Correct reproductions manufactured to original factory specifications, pre-installed firewall grommet, show quality, ready to install.

67-047141 62-68 58 inch ..... \$ 32.00 ea.  
 67-047142 62-68 69 inch ..... \$ 34.00 ea.  
 67-047143 62-68 73 inch ..... \$ 34.00 ea.  
 67-047144 62-68 lower, 23.5 inch  
 without grommet ..... \$ 32.00 ea.  
 67-047145 62-68 upper, 37.5 inch ..... \$ 34.00 ea.  
 69-047146 69-77 62 inch ..... \$ 34.00 ea.  
 69-047147 69-77 71 inch ..... \$ 34.00 ea.

### GM replacements, without grommet

69-04715 69-77 68 inch ..... \$ 32.00 ea.

## SPEEDOMETER CABLE CLIPS



Located on firewall and transmission hump.

67-04718 66-74 ..... \$ 10.00 ea.



Spring steel clip that holds speedometer cable to the speedometer.  
 69-047181 69-79 ..... \$ 6.00 ea.

## GAUGE CONVERSION KITS

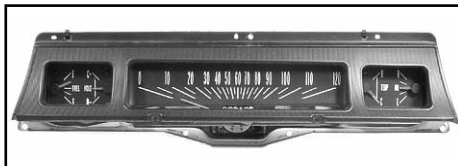

Conversion kit allows anyone with a standard Nova dash and gauges to convert to the Super Sport style gauge package. These conversion gauges are designed to fit the EXISTING openings in the back of the dash. Includes temperature sending unit & the mechanical oil pressure line and fittings. A voltmeter is standard.

66-04850 66-67 All ..... \$ 215.00 ea.

## SPEEDOMETERS



62-04801 62-64 black center ..... \$ 199.00 ea.



65-04801 65 silver center ..... \$ 209.00 ea.



66-04802 66-67 ..... \$ 236.00 ea.



Without console gauges & tachometer.  
 69-04803 69-74 ..... \$ 236.00 ea.



With console gauges & tachometer.  
 69-04804 69-74 ..... \$ 239.00 ea.



\* The following items require additional shipping and handling.

Fax Order 1-714-771-0407 • Toll Free 1-800-235-2470 • www.TruckandCarShop.com • 2014 Catalog



# CHEVROLET NOVA PARTS

Car Shop Inc. 739 North Batavia Orange, California 92868

## FUEL GAUGE CLUSTER



Standard fuel gauge dash cluster, with warning lights.

63-04810 63-64 black center ..... \$ 189.00 ea.



65-04811 65 silver center ..... \$ 189.00 ea.



SS fuel gauge dash cluster, with gauges.

63-04812 63-64 black center ..... \$ 265.00 ea.



65-04813 65 silver center ..... \$ 265.00 ea.

## FUEL GAUGES



66-04819 66-67 ..... \$ 98.00 ea.



Standard in dash fuel gauge, without console gauges.

69-04819 69-74 ..... \$ 98.00 ea.

## TACHOMETER



Reproduction of the original in-dash tachometer. Includes installation wiring and instructions. 6000 RPM with 5000 red line.

63-04809 63-65 ..... \$ 142.00 ea.



68-04809 68-74 5000 RPM red line ... \$ 239.00 ea.

## PRINTED CIRCUIT BOARD



68-04906 68-74 All ..... \$ 93.00 ea.

## TACHOMETER CONVERSION KITS



Replaces clock or blank area.

Includes wiring & instruction sheet. 7000 RPM with 6000 red line.

66-04860 63-65 ..... \$ 145.00 ea.



Replaces clock or blank area.

Includes wiring & instruction sheet. 7000 RPM with 6000 red line.

68-04860 68-70 ..... \$ 145.00 ea.

71-04860 71-72 ..... \$ 145.00 ea.

## DASH CLOCK



63-04830 63-65 ..... \$ 176.00 ea.



69-04830 69-74 ..... \$ 189.00 ea.

\* The following items require additional shipping and handling.

# CHEVROLET NOVA PARTS



Car Shop Inc. 739 North Batavia Orange, California 92868

## DASH CLOCK OPENING COVER PLATE

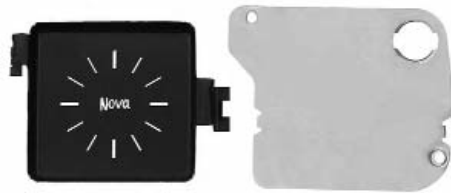

69-04835 69-74 .....\$ 49.00 ea.

## DASH LENS CLOCK HOLE PLUG



Lens plug used on 1963-65 models without a clock.

63-04839 63-65 .....\$ 9.00 ea.

## DASH CLOCK KNOB KIT



Replacement knob set includes smooth & ribbed edge knobs & retaining nut. Chrome.

67-049025 62-74 .....\$ 9.00 kit

## DEFROSTER SWITCH BEZEL

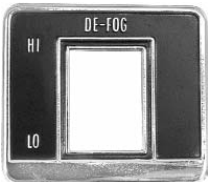

69-060081 69-74 "DE-FOG", switch bezel . \$ 29.00 ea.

## TEMPERATURE CONTROL KNOBS



67-04910 66-74 Chrome, 4 pieces .....\$ 5.00 set

## HEATER CONTROL LEVERS



66-04911 66-67 Without A/C .....\$ 57.00 set

## A/C VACUUM SWITCH CAP



67-04912 68 With A/C .....\$ 10.00 ea.

## A/C CONTROL FAN SWITCH



66-04913 66-67 With A/C .....\$ 42.00 ea.



68-04913 68 With A/C .....\$ 42.00 ea.



69-04913 69-74 With A/C .....\$ 30.00 ea.

## A/C COMPRESSOR CIRCUIT BUTTON SWITCH



62-04916 62-67 2-terminal .....\$ 39.00 ea.

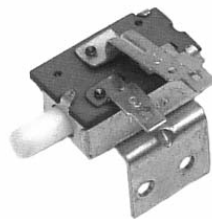

69-04916 69-74 3-terminal .....\$ 24.00 ea.

## HEATER CONTROL FAN SWITCH



63-04918 63-65 Switch, with cable, without A/C .....\$ 64.00 ea.

## HEATER CONTROL FAN SWITCH



64-076101 66-67 Without A/C .....\$ 42.00 ea.



69-04918 69-74 Without A/C .....\$ 30.00 ea.

## HEATER CONTROL PANELS

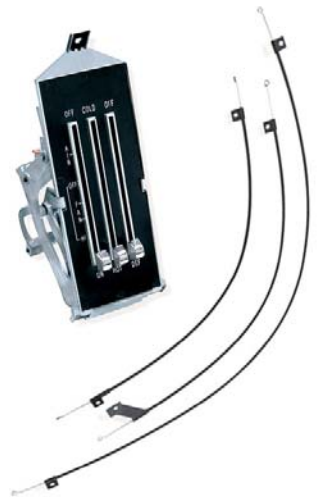

69-05010 69-74 Without A/C with cables .....\$ 235.00 ea.

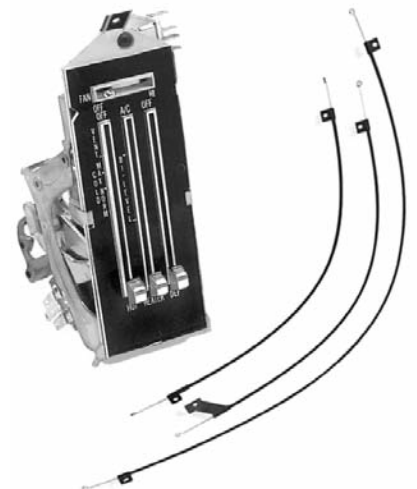

69-05012 69-74 With A/C with cables .....\$ CALL ea.

\* The following items require additional shipping and handling.

Fax Order 1-714-771-0407 • Toll Free 1-800-235-2470 • [www.TruckandCarShop.com](http://www.TruckandCarShop.com) • 2014 Catalog



# CHEVROLET NOVA PARTS

Car Shop Inc. 739 North Batavia Orange, California 92868

## HEATER CONTROL PANEL CABLE SETS

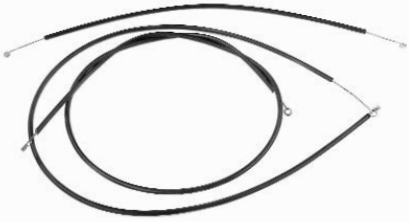

New reproduction cables.

- |          |       |             |                   |
|----------|-------|-------------|-------------------|
| 62-05021 | 62-65 | With A/C    | .....\$ 44.00 set |
| 66-05020 | 66-67 | Without A/C | .....\$ 44.00 set |

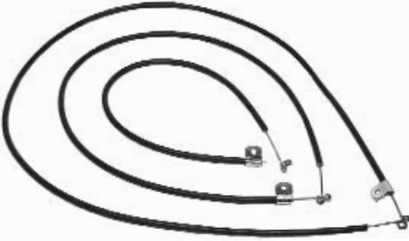

- |          |       |             |                   |
|----------|-------|-------------|-------------------|
| 69-05020 | 69-74 | Without A/C | .....\$ 42.00 set |
| 69-05021 | 69-74 | With A/C    | .....\$ 42.00 set |

## HEATER CONTROL PANEL TO DASH SCREW KIT



- |          |       |          |                  |
|----------|-------|----------|------------------|
| 69-05031 | 69-74 | 8 pieces | .....\$ 5.00 kit |
|----------|-------|----------|------------------|

## HEATER & A/C CONTROL LENSES



Features green lettering, includes a new die cut black backing plate.

- |          |       |             |                   |
|----------|-------|-------------|-------------------|
| 69-05017 | 69-74 | Heater lens | .....\$ 16.00 ea. |
| 69-05018 | 69-74 | A/C lens    | .....\$ 16.00 ea. |

## AIR DUCT HOSE



6 foot section.

- |           |                      |                   |
|-----------|----------------------|-------------------|
| 67-051041 | 2 3/4", cloth type   | .....\$ 35.00 ea. |
| 67-051042 | 2 3/4", plastic type | .....\$ 15.00 ea. |

## FRESH AIR VENT CABLE KNOBS



- |          |       |       |                  |
|----------|-------|-------|------------------|
| 65-05030 | 65-66 | Black | .....\$ 6.00 pr. |
|----------|-------|-------|------------------|



- |          |       |       |                  |
|----------|-------|-------|------------------|
| 67-05031 | 67-72 | Black | .....\$ 7.00 pr. |
|----------|-------|-------|------------------|

## FRESH AIR VENT CABLES



Vent cable with bracket & knob.

- |          |       |          |                   |
|----------|-------|----------|-------------------|
| 62-05035 | 62-64 | LH or RH | .....\$ 39.00 ea. |
|----------|-------|----------|-------------------|



Vent cable with knob.

- |          |       |          |                   |
|----------|-------|----------|-------------------|
| 65-05036 | 65-66 | LH or RH | .....\$ 31.00 ea. |
|----------|-------|----------|-------------------|



Vent cable with knob.

- |          |       |          |                   |
|----------|-------|----------|-------------------|
| 67-05037 | 67-72 | LH or RH | .....\$ 31.00 ea. |
|----------|-------|----------|-------------------|

## AIR DUCT SEAL KIT



- |          |       |                   |
|----------|-------|-------------------|
| 69-05109 | 69-74 | .....\$ 19.00 set |
|----------|-------|-------------------|

## SIDE AIR OUTLET VENT ASSEMBLY



- |           |       |                 |                   |
|-----------|-------|-----------------|-------------------|
| 69-051011 | 69-74 | LH, without A/C | .....\$ 89.00 ea. |
| 69-051012 | 69-74 | RH, without A/C | .....\$ 89.00 ea. |



- |           |       |              |                    |
|-----------|-------|--------------|--------------------|
| 69-051013 | 69-74 | RH, with A/C | .....\$ 115.00 ea. |
|-----------|-------|--------------|--------------------|

## SIDE AIR OUTLET VENTS



LH or RH side vent

- |          |       |                   |
|----------|-------|-------------------|
| 69-05101 | 69-76 | .....\$ 21.00 ea. |
|----------|-------|-------------------|

## SIDE AIR OUTLET VENT RETAINER



Holds the air outlet vent assembly in the passenger side of the dash

- |           |       |              |                   |
|-----------|-------|--------------|-------------------|
| 69-051015 | 69-74 | RH, with A/C | .....\$ 21.00 ea. |
|-----------|-------|--------------|-------------------|

# CHEVROLET NOVA PARTS



Car Shop Inc. 739 North Batavia Orange, California 92868

## A/C OUTLET BEZEL FASTENER KIT



69-051017 69-74 11 pieces .....\$ 6.00 kit

## CENTER AIR OUTLET VENTS



Must cut open assembly to replace.

69-05111 69-79 Center A/C vent, 2 req. . \$ 13.00 ea.

## CENTER AIR OUTLET VENT ASSEMBLY



69-05112 69-72 .....\$ 78.00 ea.

## AC DASH DUCT



AC center plastic dash duct, 4 openings, replaces GM# 3937166.

69-051102 69-72 .....\$ 88.00 ea.



AC center plastic dash duct adapter, 2 openings, replaces GM# 3937169.

69-051103 69-72 .....\$ 63.00 ea.

## DEFROSTER DUCT



67-05114 68 Under dash .....\$ 120.00 ea.

69-05115 69-79 Under dash .....\$ 120.00 ea.

## AC DUCT DEFLECTOR



67-051091 68-74 .....\$ 44.00 ea.

## LOWER HEATER DEFLECTOR DUCT



Mounts on the heater box and deflects air around the console.

67-051092 68-74 .....\$ 65.00 ea.

## INSIDE DOOR HANDLE



61-06607 62-64 LH or RH .....\$ 10.00 ea.



67-05201 65-67 LH or RH .....\$ 9.00 ea.



68-05204 68-74 LH .....\$ 11.00 ea.



68-05205 68-74 RH .....\$ 11.00 ea.



75-05207 75-79 LH .....\$ 11.00 ea.

75-05208 75-79 RH .....\$ 11.00 ea.

## INSIDE DOOR HANDLE BEZELS



75-05213 75-79 LH & RH, Black .....\$ 24.00 pr.

75-05214 75-79 LH & RH, Camel Tan ...\$ 24.00 pr.

75-05215 75-79 LH & RH, Dark Blue ..\$ 24.00 pr.

75-05216 75-79 LH & RH, Red .....\$ 24.00 pr.

75-05217 75-79 LH & RH, Oyster .....\$ 24.00 pr.

75-05218 75-79 LH & RH, Doeskin ....\$ 24.00 pr.

## INSIDE DOOR HANDLE MECHANISMS



66-05226 66 LH .....\$ 34.00 ea.

66-05227 66 RH .....\$ 34.00 ea.



67-05229 67 LH .....\$ 34.00 ea.

67-05230 67 RH .....\$ 34.00 ea.

## DOOR OPENING ROD HARDWARE



### Door opening rod end clips

67-052324 LH & RH .....\$ 5.00 pr.



### Door opening rod center guide bracket

67-052325 68-72 LH or RH .....\$ 7.50 ea.



### Door latch end clip

62-052324 LH & RH .....\$ 2.00 pr.

+ The following items require additional shipping and handling.

Fax Order 1-714-771-0407 • Toll Free 1-800-235-2470 • [www.TruckandCarShop.com](http://www.TruckandCarShop.com) • 2014 Catalog



# CHEVROLET NOVA PARTS

Car Shop Inc. 739 North Batavia Orange, California 92868

## VENT WINDOW HANDLES

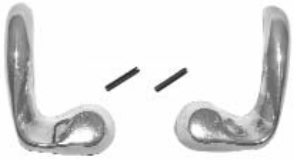

Vent window handles with retainer pins.

64-03622 62-67 .....\$ 28.00 pr.



Vent window handles with retainer pins.

68-03622 68-74 .....\$ 46.00 pr.



67-05234 62-74 retainer pin only .....\$ 1.00 ea.

## VENT WINDOW PIVOT RIVET



58-04120 62-67 .....\$ 2.00 ea.

## VENT WINDOW GLASS FRAMES



62-05256 62-67 LH, all .....\$ 55.00 ea.

62-05257 62-67 RH, all .....\$ 55.00 ea.

68-05256 68-74 LH, all .....\$ 55.00 ea.

68-05257 68-74 RH, all .....\$ 55.00 ea.

## WINDOW HANDLE WASHER & SPRINGS



67-05313 62-79 Plastic washer plate . . . \$ 2.00 ea.

67-05314 62-79 Door handle-to-panel inside springs .....\$ 1.50 ea.

## INSIDE WINDOW HANDLES



61-06517 62-64 with black knob .....\$ 10.00 ea.



65-06518 62-64 with chrome knob .....\$ 10.00 ea.



65-065191 65-66 with black knob .....\$ 11.00 ea.



65-06519 65-66 with chrome knob .....\$ 11.00 ea.



67-05301 67 with black knob .....\$ 10.00 ea.



67-053011 67 with clear knob .....\$ 11.00 ea.



68-05303 68-79 with black knob .....\$ 5.00 ea.



68-05305 68-79 with clear knob .....\$ 5.00 ea.

## CONCOURSE CORRECT INSIDE WINDOW CRANK HANDLES



Not your generic aftermarket handles. Each handle has the correct shape and design of the original. Features correct cast numeric text, knob design, spline depth and engagement.

Includes 2 front & 2 rear handles.

68-053051 68-72 with black knobs .....\$ 49.00 set

68-053052 68-72 with clear knobs .....\$ 49.00 set



### FRONT

68-053053 68-72 with black knob .....\$ 13.00 ea.

68-053054 68-72 with clear knob .....\$ 13.00 ea.



### REAR

68-053055 68-72 with black knob .....\$ 13.00 ea.

68-053056 68-72 with clear knob .....\$ 13.00 ea.

## WINDOW CRANK KNOBS



68-05309 68-72 Medium Red .....\$ 6.50 pr.

68-05311 68-72 White .....\$ 6.50 pr.

68-05312 68-72 Medium Blue .....\$ 6.50 pr.

## INTERIOR HANDLE CLIP



68-053059 62-79 Clip .....\$ .25 ea.

## INTERIOR HANDLE REMOVAL TOOL



Removes interior door & window crank handles.

67-05315 All .....\$ 4.00 ea.



# CHEVROLET NOVA PARTS



Car Shop Inc. 739 North Batavia Orange, California 92868

## WINDOW REGULATORS



|          |       |                   |              |
|----------|-------|-------------------|--------------|
| 69-05316 | 69-72 | LH, front, 2-door | \$ 99.00 ea. |
| 69-05317 | 69-72 | RH, front, 2-door | \$ 99.00 ea. |
| 69-05318 | 69-72 | LH, front, 4-door | \$ 89.00 ea. |
| 69-05319 | 69-72 | RH, front, 4-door | \$ 89.00 ea. |
| 69-05320 | 69-72 | LH, rear, 4-door  | \$ 89.00 ea. |
| 69-05321 | 69-72 | RH, rear, 4-door  | \$ 89.00 ea. |

## QUARTER WINDOW REGULATORS

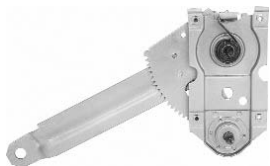

|          |       |                  |              |
|----------|-------|------------------|--------------|
| 68-05332 | 68-71 | LH, rear, 2-door | \$ 79.00 ea. |
| 68-05333 | 68-71 | RH, rear, 2-door | \$ 79.00 ea. |

## WINDOW REGULATOR ROLLERS



1 roller & 1 rivet, 3 per regulator.

|          |       |          |             |
|----------|-------|----------|-------------|
| 67-05324 | 62-72 | front    | \$ 4.00 ea. |
|          | 62-65 | rear 1/4 |             |

## DOOR GLASS SETTING CHANNEL



|          |       |    |              |
|----------|-------|----|--------------|
| 62-05325 | 62-65 | LH | \$ 54.00 ea. |
| 62-05326 | 62-65 | RH | \$ 54.00 ea. |

## DOOR WINDOW LOWER STOP



1 required per door, plated stamped steel with coated tip.

|           |       |  |              |
|-----------|-------|--|--------------|
| 62-053291 | 62-65 |  | \$ 12.00 ea. |
|-----------|-------|--|--------------|

## QUARTER WINDOW GUIDES



|          |       |        |              |
|----------|-------|--------|--------------|
| 68-05340 | 68-72 | 2-door | \$ 35.00 kit |
|----------|-------|--------|--------------|

## TAILGATE GLASS SETTING CHANNEL



|          |       |  |               |
|----------|-------|--|---------------|
| 62-05360 | 62-64 |  | \$ 109.00 ea. |
|----------|-------|--|---------------|

## DOOR LOCK STRIKER



This is the bolt that catches the door lock assembly.

|          |       |                      |              |
|----------|-------|----------------------|--------------|
| 67-05413 | 68-74 | replacement          | \$ 8.00 ea.  |
| 67-05414 | 68-74 | correct reproduction | \$ 11.00 ea. |

## DOOR LOCK STRIKER WASHER



Allows you to adjust the striker without marring the paint.

|           |       |  |             |
|-----------|-------|--|-------------|
| 67-054142 | 68-74 |  | \$ 3.50 pr. |
|-----------|-------|--|-------------|

## DOOR LATCH MECHANISM



Correct for 1966-1967, replacement for 1963-1965.

|          |       |    |              |
|----------|-------|----|--------------|
| 66-05408 | 63-67 | LH | \$ 68.00 ea. |
| 66-05409 | 63-67 | RH | \$ 68.00 ea. |

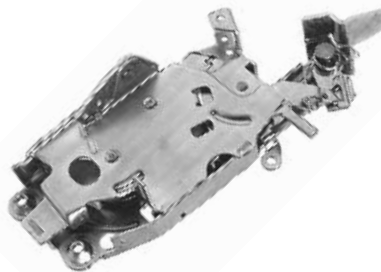

This is the lock assembly that catches around the door lock striker bolt.

|          |       |    |              |
|----------|-------|----|--------------|
| 69-05408 | 69-70 | LH | \$ 64.00 ea. |
| 69-05409 | 69-70 | RH | \$ 64.00 ea. |

## DOOR LATCH MECHANISM SPRING



Attaches to the door lock release arm in the door latch mechanism.

|          |       |    |             |
|----------|-------|----|-------------|
| 67-05415 | 68-74 | LH | \$ 4.00 ea. |
| 67-05416 | 68-74 | RH | \$ 4.00 ea. |

## DOOR LATCH MECHANISM SCREWS



1/4-20 x 5/8, .48 O.D., cadmium plated, correct domed head.

|          |       |             |             |
|----------|-------|-------------|-------------|
| 67-05412 | 62-74 | 6-piece set | \$ 4.50 set |
|----------|-------|-------------|-------------|

## EXTERIOR DOOR HANDLE BOLTS



1/4-20 x 1/2, 5/16 hex, with .50 conical washer.

|           |       |          |             |
|-----------|-------|----------|-------------|
| 67-054235 | 62-79 | 4 pieces | \$ 4.50 set |
|-----------|-------|----------|-------------|

## DOOR HANDLE KIT



**Import**  
Kit contains LH & RH door handles, LH & RH push buttons, gaskets & screws. Everything is assembled and ready to install.

|          |       |                   |              |
|----------|-------|-------------------|--------------|
| 62-05420 | 62-65 | 2 or 4 door front | \$ 49.00 kit |
| 66-05420 | 66-67 | 2 or 4 door front | \$ 49.00 kit |
| 68-05420 | 68-79 | 2 door            | \$ 49.00 kit |

## Made in USA

|          |       |                   |              |
|----------|-------|-------------------|--------------|
| 62-05421 | 62-65 | 2 or 4 door front | \$ 86.00 kit |
| 62-05422 | 62-65 | 4 door rear       | \$ 86.00 kit |
| 66-05421 | 66-67 | 2 or 4 door front | \$ 83.00 kit |
| 66-05422 | 66-67 | 4 door rear       | \$ 83.00 kit |
| 68-05421 | 68-79 | 2 door            | \$ 83.00 kit |
| 68-05422 | 68-79 | 4 door front      | \$ 83.00 kit |
| 68-05423 | 68-79 | 4 door rear       | \$ 83.00 kit |

## DOOR HANDLE PUSH BUTTON KIT



Includes 2 push buttons with rods, 2 o-rings, 2 springs and 2 retainers.

|          |       |  |              |
|----------|-------|--|--------------|
| 67-05424 | 62-79 |  | \$ 10.00 pr. |
|----------|-------|--|--------------|



Push button rubber o-ring.

|          |       |  |             |
|----------|-------|--|-------------|
| 67-05425 | 62-79 |  | \$ 2.00 ea. |
|----------|-------|--|-------------|

## DOOR HANDLE AND LOCK GASKETS



Includes gaskets for both outer door handles and door locks.

|          |       |  |             |
|----------|-------|--|-------------|
| 61-06726 | 62-65 |  | \$ 4.00 set |
| 68-03735 | 66-67 |  | \$ 4.00 set |
| 67-05426 | 68-79 |  | \$ 4.00 set |

+ The following items require additional shipping and handling.



# CHEVROLET NOVA PARTS

Car Shop Inc. 739 North Batavia Orange, California 92868

## UPPER DOOR HINGES



62-05501 62-66 LH or RH ..... \$ 49.00 ea.



69-05504 68-79 LH ..... \$ 44.00 ea.  
69-05505 68-79 RH ..... \$ 44.00 ea.

## LOWER DOOR HINGES



62-05510 62-67 LH ..... \$ 59.00 ea.  
62-05511 62-67 RH ..... \$ 59.00 ea.



69-05514 68-79 LH ..... \$ 49.00 ea.  
69-05515 68-79 RH ..... \$ 49.00 ea.

## LOWER DOOR HINGE SPRING



68-05518 68-79 LH or RH ..... \$ 6.00 ea.

## DOOR HINGE BOLT KITS



Each kit mounts two hinges.

62-05519 62-67 Upper or lower ..... \$ 12.00 kit  
68-05521 68-79 Upper LH & RH ..... \$ 14.00 kit  
68-05522 68-79 Lower LH & RH ..... \$ 16.00 kit

## DOOR HINGE BOLT



67-05524 62-67 Phillips head type ..... \$ 1.25 ea.  
67-05525 62-79 Hex head type ..... \$ 1.25 ea.

## DOOR HINGE PIN & BUSHING KITS



67-05526 68-79 does 4 hinges ..... \$ 19.00 kit

## DOOR HINGE PIN BUSHINGS



67-05528 68-79 Small smooth bushing .. \$ 1.00 ea.  
69-05529 68-79 Large ribbed bushing .. \$ 1.00 ea.

## LOWER DOOR HINGE DETENT KIT



68-05531 68-79 LH & RH ..... \$ 19.00 pr.

## INTERIOR MIRROR ANTI-MOVEMENT INSERT



67-056061 62-72 insert ..... \$ 2.00 ea.

## INNER REAR VIEW MIRROR SCREW



67-05606 62-72 chrome ..... \$ 3.00 ea.

## INNER REAR VIEW MIRROR



Standard chrome mirror.

67-05602 62-67 8", standard ..... \$ 19.00 ea.



With black twist knob, without rubber trim, polished stainless steel.

62-05603 62-65 8", day/night ..... \$ 46.00 ea.



Polished stainless steel.

67-05603 66-68 8" day/night ..... \$ 30.00 ea.



Polished stainless steel.

69-05604 69-72 10" day/night ..... \$ 30.00 ea.



Polished stainless steel.

70-05605 73-79 day/night ..... \$ 39.00 ea.

\* The following items require additional shipping and handling.

# CHEVROLET NOVA PARTS



Car Shop Inc. 739 North Batavia Orange, California 92868

## INNER REAR VIEW MIRROR



70-05601 73-79 day/night, black, 10" ... \$ 16.00 ea.



Ball milled billet aluminum, chrome, does not include flat bracket  
70-056052 73-79 chrome, 10" ... \$ 39.00 ea.

## INNER REAR VIEW MIRROR BRACKET



Replaces GM # 4873289.  
62-05607 62-63 Convertible ... \$ 49.00 ea.



Replaces GM # 4873292.  
62-05608 62-65 Coupe ... \$ 29.00 ea.



Replaces GM # 4867668.  
66-05608 62-65 Sedan or wagon  
66-67 all ... \$ 30.00 ea.

## INNER REAR VIEW MIRROR BRACKET



68-05609 68-72 ... \$ 34.00 ea.



Mounts to windshield.  
70-05611 73-79 flat bracket ... \$ 4.00 ea.



70-056112 73-79 adhesive ... \$ 4.00 ea.

## REAR VIEW MIRROR BRACKET BOOT



71-038112 68-72 ... \$ 24.00 ea.

## VANITY MIRROR



67-05601 62-67 ... \$ 32.00 ea.



Truck Shop & Car Shop offers parts catalogs for:

- 1941-1957 Fullsize Chevrolet cars
- 1958-1972 Fullsize Chevrolet cars
- 1967-1981 Camaro
- 1964-1987 Chevelle / El Camino
- 1962-1974 Chevy II / Nova
- 1964-1973 Mustang
- 1947-1959 Chevrolet/GMC Truck
- 1960-1972 Chevrolet/GMC Truck
- 1973-1991 Chevrolet/GMC Truck
- 1948-1986 Ford Truck
- 1966-1986 Ford Bronco

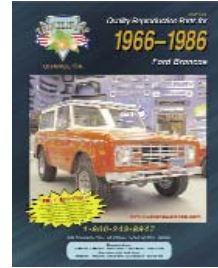
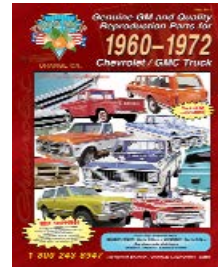
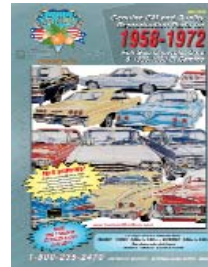
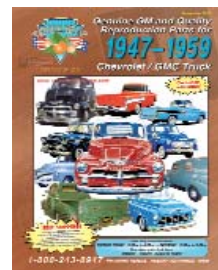
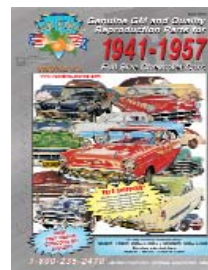

+ The following items require additional shipping and handling.

Fax Order 1-714-771-0407 • Toll Free 1-800-235-2470 • [www.TruckandCarShop.com](http://www.TruckandCarShop.com) • 2014 Catalog



# CHEVROLET NOVA PARTS

Car Shop Inc. 739 North Batavia Orange, California 92868

## MIRRORS, EXTERIOR



Includes gasket and hardware.

61-02844 62 LH or RH .....\$ 35.00 ea.



Features the correct stainless steel glass retaining ring and embossed "Bowtie" emblem just like the original!  
Our glass is not glued in like others in the market place.

63-02845 63-65 LH or RH .....\$ 28.00 ea.

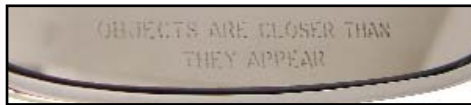

Features convex glass, (objects are closer than they appear)

63-02845 63-65 RH .....\$ 57.00 ea.



Features the correct stainless steel glass retaining ring, embossed "Bowtie" emblem and correct base with raised line down the middle, just like the original!

Includes gasket, bracket and hardware.

67-05701 66-72 LH or RH .....\$ 28.00 ea.

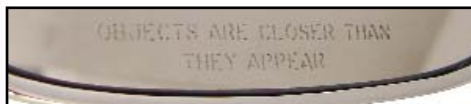

Features convex glass, (objects are closer than they appear)

67-05701 66-72 RH .....\$ 57.00 ea.

## REMOTE DOOR MIRROR



Includes hardware and gasket.

67-05705 67 LH .....\$ 139.00 ea.

## REMOTE MIRROR INNER DOOR PANEL BEZEL



67-05712 67 chrome .....\$ 22.00 ea.

## REMOTE MIRROR PIVOT PLATE



64-02926 64-66 .....\$ 32.00 ea.

## MIRROR MOUNTING KIT



61-02916 62 Mounting kit, LH or RH . \$ 6.00 kit



63-02917 63-65 Mounting kit, LH or RH . \$ 6.00 kit



67-05710 66-72 Mounting kit, LH or RH . \$ 5.00 kit

## MIRROR MOUNTING GASKETS



67-05617 66-72 .....\$ 2.00 ea.

## EXTERIOR MIRROR SCREWS



10-16 x 1/2, with star washer, bracket to door screw.

67-05730 63-72 .....\$ 1.00 pr.



10-24 x 3/4, mirror to bracket screw, chrome on stainless.

67-05731 63-72 .....\$ 1.00 ea.

## CONVERTIBLE TOPS



With Plastic rear window

62-05801 62-63 Black .....\$ 289.00 set

62-05802 62-63 White .....\$ 289.00 set

## CONVERTIBLE TOP PAD KIT



Fits between frame rails and top material.

62-05805 62-63 Black .....\$ 52.00 pr.

## CONVERTIBLE TOP TACK STRIP



Made from galvanized channel with plastic tacking material pressed in.

62-05805+ 62-63 .....\$ 159.00 set

# CHEVROLET NOVA PARTS



Car Shop Inc. 739 North Batavia Orange, California 92868

## CONVERTIBLE WELL MOLDING CLIPS



Used to secure the stainless steel molding that runs around the well area.  
**62-05814** 62-63 .....\$ 2.50 ea.

## DOOR ALIGNMENT WEDGES



**63-05815** 63 convertible .....\$ 36.00 set



**67-05815** 66-67 2-door hardtop .....\$ 38.00 set

## CONVERTIBLE TOP WELL LINER

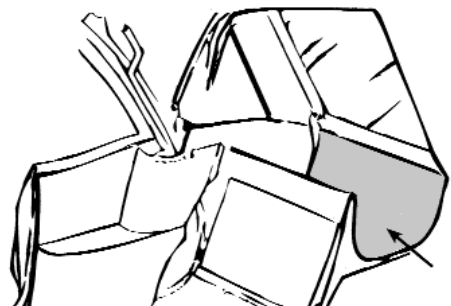

Protects top when in the down position. Fits behind the rear seat.  
**62-05816** 62-63 Black .....\$ 65.00 ea.

## CONVERTIBLE TOP LATCH HANDLES



Complete assemblies with handles, hook & screws.  
**61-05016** 62-63 LH, made in USA ....\$ 174.00 ea.  
**61-05017** 62-63 RH, made in USA ....\$ 174.00 ea.  
 Complete assemblies with handles & hooks.  
**61-050171** 62-63 LH & RH, import .....\$ 229.00 pr.

## CONVERTIBLE TOP LATCH SCREWS



**61-05021** 62-63 Chrome .....\$ 3.00 pr.

## CONVERTIBLE TOP LATCH HOOKS



Screws into the top latch to retain the top.  
**61-050191** 62-63 .....\$ 15.00 ea.

## CONVERTIBLE TOP LATCH BUSHINGS



**61-05022** 62-63 with retainers .....\$ 17.00 set

## CONVERTIBLE TOP CABLES



**62-05904** 62-63 .....\$ 34.00 pr.

## CONVERTIBLE TOP BOOTS



Top boots fit over the top well when the top is down.  
**62-05906** 62-63 Black .....\$ 149.00 ea.  
**62-05907** 62 Bright Red .....\$ 149.00 ea.  
**62-05908** 63 Red .....\$ 149.00 ea.  
**62-05909** 62-63 Aqua .....\$ 149.00 ea.  
**62-05910** 62-63 Light Blue .....\$ 149.00 ea.  
**62-05911** 62-63 Fawn .....\$ 149.00 ea.  
**62-05912** 62-63 Saddle .....\$ 149.00 ea.  
**62-05913** 62-63 White .....\$ 149.00 ea.

## CONVERTIBLE TOP BOOT STORAGE BAG



Available in black only.  
**59-19230** 62-63 .....\$ 28.00 ea.

## CONVERTIBLE TOP CYLINDERS



Replace your worn hydraulic cylinders with these new replacements.  
 Made in U.S.A.  
**62-05920** 62-63 LH or RH .....\$ 149.00 ea.

## CONVERTIBLE TOP CYLINDER MOUNT BOLTS



**62-050081** 62-63 .....\$ 8.00 ea.

## CONVERTIBLE TOP MOTOR/PUMP



Brand new unit, works the same as the original.  
**62-04920** 62 .....\$ 269.00 ea.

## CONVERTIBLE PUMP MOUNTING GROMMETS



**58-05002** 62-63 .....\$ 2.00 ea.

## CONVERTIBLE TOP HOSE KIT



Made in U.S.A.  
**62-06002** 62-63 .....\$ 109.00 kit

+ The following items require additional shipping and handling.



# CHEVROLET NOVA PARTS

Car Shop Inc. 739 North Batavia Orange, California 92868

## SPRAY ADHESIVE



Permatex all purpose spray adhesive.

67-060091 10.5 oz. .... \$ 9.00 can

Permatex heavy duty headliner & carpet spray adhesive.

67-060092 16.75 oz. .... \$ 15.00 can

3M Super trim adhesive, bonds heavyweight automotive materials.

67-06009 19 oz. .... \$ 24.00 can

## VINYL TOPS



Our vinyl tops are made from the same weight and grain vinyl as the original. Other colors available. Call for pricing.

### 2-DOOR HARDTOP

62-06010 62-65 Black ..... \$ 148.00 ea.

62-06011 62-65 White ..... \$ 148.00 ea.

66-06010 66-67 Black ..... \$ 148.00 ea.

66-06011 66-67 White ..... \$ 148.00 ea.

### 2-OR 4-DOOR SEDAN

66-06012 66-67 Black ..... \$ 148.00 ea.

66-06013 66-67 White ..... \$ 148.00 ea.

68-06012 68-74 Black ..... \$ 148.00 ea.

68-06013 68-74 White ..... \$ 148.00 ea.

## VINYL TOP MOLDINGS



68-06014 68-74 2-door ..... \$ 139.00 set



68-06015 68-74 corner moldings ..... \$ 62.00 pr.



68-023231 68-74 molding clip ..... \$ 1.50 ea.

## WINDSHIELD SEALS



62-06080 62-63 convertible ..... \$ 120.00 ea.

62-06081 62-67 2-dr. Hardtop ..... \$ 47.00 ea.

62-06082 62-67 Sedan/Wagon ..... \$ 47.00 ea.

## REAR WINDOW SEALS



62-06090 62-65 2-dr. Hardtop ..... \$ 52.00 ea.

62-06091 62-64 Sedan ..... \$ 52.00 ea.

65-06091 65 Sedan ..... \$ 135.00 ea.

## WINDOW RIBBON SEAL



### Front or Rear window seal

65-03414 68-74 front

66-67 hardtop rear

66-72 sedan rear ..... \$ 15.00 ea.

## ROOF RAIL WEATHERSTRIP

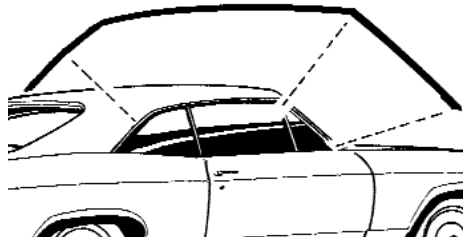

Thick rubber piece that follows the outer edge of the roof line. Features molded ends just like the originals.

62-06101 62-64 Hardtop ..... \$ 57.00 pr.

65-06102 65 Hardtop ..... \$ 45.00 pr.

66-06103 66-67 Hardtop ..... \$ 50.00 pr.

## DOOR WEATHERSTRIP

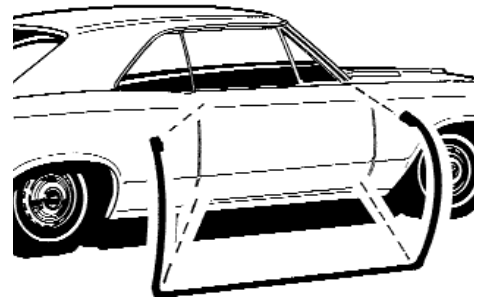

Mounting clips are pre-installed for easy installation.

62-06110 62-67 Hardtop  
62-63 convertible ..... \$ 45.00 pr.

62-06111 62-67 2-door sedan ..... \$ 45.00 pr.

62-06112 62-67 4-door sedan, front  
62-67 4-door wagon, front ... \$ 45.00 pr.

62-06113 62-67 4-door sedan, rear ... \$ 45.00 pr.

62-06114 62-67 4-door wagon, rear ... \$ 45.00 pr.

68-06115 68-74 2-door ..... \$ 45.00 pr.

68-06116 68-74 4-door sedan, front ... \$ 45.00 pr.

68-06117 68-74 4-door sedan, rear ... \$ 45.00 pr.

## GLASS FRAME WEATHERSTRIP

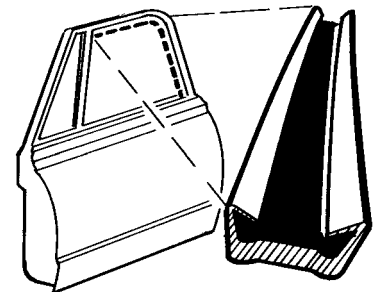

This is the felt strip that runs from down in the door, around the upper frame, and back down (window jams up into it). Does 2 doors.

64-04232 62-74 sedan & wagon ..... \$ 25.00 pr.

## WINDOW CHANNEL LINER



67-06240 Universal ..... \$ 2.50 ft.

# CHEVROLET NOVA PARTS



Car Shop Inc. 739 North Batavia Orange, California 92868

## VENT WINDOW WEATHERSTRIP

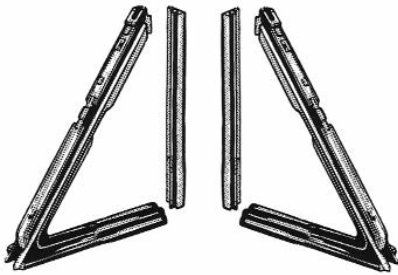

Triangle shaped weatherstrip that fits in vent window frame.

62-06118 62-63 convertible ..... \$ 69.00 pr.  
62-67 hardtop .....

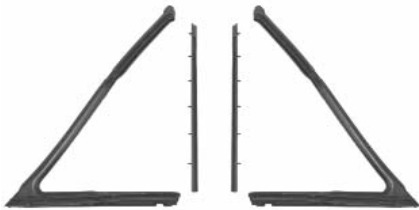

62-06118 62-67 2 or 4-door sedan .... \$ 69.00 pr.  
68-06118 68-72 .....

## DOOR GLASS VERTICAL RUN CHANNELS



U-Shaped channel located in the division bar.

63-03642 62-67 ..... \$ 29.00 pr.

## UPPER DOOR WINDOW STOPS



Fits above the run channel in the vent window assembly.

62-06123 62-63 convertible ..... \$ 27.00 pr.  
62-65 hardtop .....

66-06123 66-67 hardtop ..... \$ 28.00 pr.

## QUARTER WINDOW WEATHERSTRIP

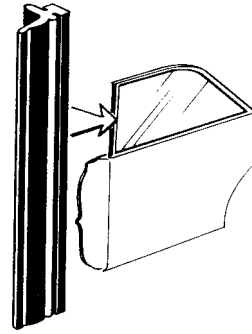

62-06120 62-65 ..... \$ 14.00 pr.  
66-06120 66-67 .....

## QUARTER WINDOW GLASS RUN CHANNEL KIT



68-06120 68-72 2-door ..... \$ 119.00 kit

## U-SHAPED DOOR JAMB RUBBER



61-03708 62-63 convertible ..... \$ 23.00 pr.



62-06122 62-65 hardtop ..... \$ 19.00 pr.



66-06122 66-67 hardtop ..... \$ 24.00 pr.

## U-SEAL SCREW KIT



67-061211 62-67 4 pieces ..... \$ 2.50 set

## REAR DOOR STATIONARY VENT WINDOW SEALS



62-06130 62-65 4-door sedan ..... \$ 150.00 pr.  
66-06130 66-67 4-door sedan .....



62-06131 62-67 4-door wagon ..... \$ 100.00 pr.

## REAR STATIONARY SIDE WINDOW WEATHERSTRIP

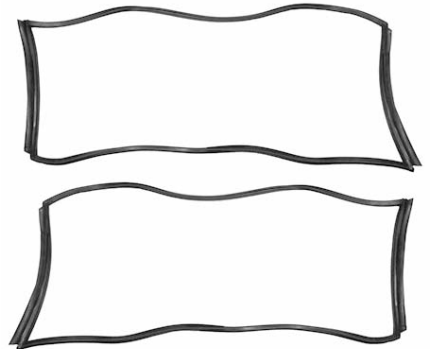

62-06135 62-67 wagon ..... \$ 229.00 pr.

## TRUNK WEATHERSTRIP



64-04405 62-74 ..... \$ 19.00 ea.  
73-04405 73-79 hatchback seal ..... \$ 70.00 ea.

## WEATHERSTRIP ADHESIVE



Used for bonding rubber weatherstrip to metal. Black.  
64-06016 weatherstrip adhesive ..... \$ 8.00 ea.

\* The following items require additional shipping and handling.

Fax Order 1-714-771-0407 • Toll Free 1-800-235-2470 • [www.TruckandCarShop.com](http://www.TruckandCarShop.com) • 2014 Catalog



# CHEVROLET NOVA PARTS

Car Shop Inc. 739 North Batavia Orange, California 92868

## WINDOW FELT KIT "ORIGINAL STYLE"

Stop window rattles with this complete set of window felts. Includes pre-attached hardware and chrome bead for easy installation. Enough pieces to do all of your windows inside and outside. Our "Original Style" feature the correct rounded chrome bead on the outer edge and a thicker flocked felt inside edge.

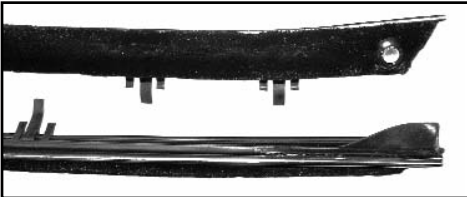
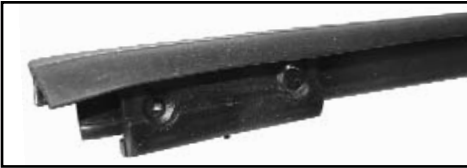

|          |       |                                |           |     |
|----------|-------|--------------------------------|-----------|-----|
| 62-06201 | 62-65 | 2-door hardtop, 8 pcs. . . .   | \$ 83.00  | kit |
| 62-06202 | 62-63 | convertible, 8 pcs. . . . .    | \$ 74.00  | kit |
| 62-06203 | 62-65 | 2-door sedan, 8 pcs. . . . .   | \$ 79.00  | kit |
| 62-06204 | 62-65 | 4-door sedan                   |           |     |
|          | 62-65 | 4-door wagon, 8 pcs. . . . .   | \$ 76.00  | kit |
| 66-06201 | 66-67 | 2-door hardtop, 8 pcs. . . . . | \$ 106.00 | kit |
| 66-06202 | 66-67 | 2-door sedan, 8 pcs. . . . .   | \$ 85.00  | kit |
| 66-06203 | 66-67 | 4-door sedan, 8 pcs. . . . .   | \$ 72.00  | kit |
| 68-06201 | 68-72 | 2-door sedan, 8 pcs. . . . .   | \$ 109.00 | kit |

## WINDOW FELT KIT "REPLACEMENT STYLE"



Note: If your car is a daily driver, our reproductions will more than do the job, however, if you will be showing the car, we highly recommend going with an original style.

|          |       |                                |          |     |
|----------|-------|--------------------------------|----------|-----|
| 66-06209 | 66-67 | 2-door hardtop, 8 pcs. . . . . | \$ 69.00 | kit |
| 66-06210 | 66-67 | 2-door sedan, 8 pcs. . . . .   | \$ 71.00 | kit |
| 68-06209 | 68-72 | 2-door sedan, 8 pcs. . . . .   | \$ 74.00 | kit |
| 68-06210 | 68-72 | 4-door sedan, 8 pcs. . . . .   | \$ 64.00 | kit |
| 73-06211 | 73-74 | 2-door sedan, 8 pcs. . . . .   | \$ 72.00 | kit |

## TAILGATE WINDOW FELT KIT "ORIGINAL STYLE"

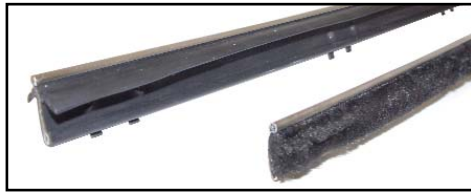

|          |       |                 |          |     |
|----------|-------|-----------------|----------|-----|
| 62-06215 | 62-65 | wagon . . . . . | \$ 44.00 | pr. |
| 66-06215 | 66-67 | wagon . . . . . | \$ 48.00 | pr. |

## WINDOW FELT CLIPS



|          |         |         |         |         |         |
|----------|---------|---------|---------|---------|---------|
|          | style 1 | style 2 | style 3 | style 4 |         |
| 58-02750 | style 1 | style 2 | style 3 | style 4 | .50 ea. |
| 58-02751 | style 1 | style 2 | style 3 | style 4 | .50 ea. |
| 58-02752 | style 1 | style 2 | style 3 | style 4 | .50 ea. |
| 58-02753 | style 1 | style 2 | style 3 | style 4 | .50 ea. |

## HOOD TO COWL SEAL



This is the long rubber strip that runs along the back edge of the hood and is mounted on the firewall.

|          |       |           |          |     |
|----------|-------|-----------|----------|-----|
| 62-06223 | 62-67 | . . . . . | \$ 12.00 | ea. |
| 67-06223 | 68-74 | . . . . . | \$ 8.00  | ea. |

## FIREWALL / COWL PANEL SEAL KIT



Includes: steering column to firewall, hood to cowl, wiper motor and under cowl panel outer seals.

|          |       |           |          |     |
|----------|-------|-----------|----------|-----|
| 69-06227 | 68-74 | . . . . . | \$ 17.00 | kit |
|----------|-------|-----------|----------|-----|

## HEADLIGHT BEZEL SEALS



|          |    |           |         |     |
|----------|----|-----------|---------|-----|
| 67-06235 | 67 | . . . . . | \$ 9.00 | pr. |
|----------|----|-----------|---------|-----|

## INNER FRONT FENDER SEAL



|          |       |                        |          |     |
|----------|-------|------------------------|----------|-----|
| 62-06230 | 62-65 | with clips . . . . .   | \$ 17.00 | pr. |
| 66-06230 | 66-67 | with staples . . . . . | \$ 13.00 | pr. |

## CONVERTIBLE PILLAR POST WEATHERSTRIP



These are the thick rubber pieces that go up the sides of the windshield post.

|          |       |                       |          |     |
|----------|-------|-----------------------|----------|-----|
| 62-06301 | 62-63 | Convertible . . . . . | \$ 54.00 | pr. |
|----------|-------|-----------------------|----------|-----|

## CONVERTIBLE TOP RUBBER BUMPERS



|          |       |                       |         |     |
|----------|-------|-----------------------|---------|-----|
| 62-06302 | 62-63 | Convertible . . . . . | \$ 7.50 | pr. |
|----------|-------|-----------------------|---------|-----|

## CONVERTIBLE TOP WEATHERSTRIP KITS



Kit comes complete with all seven weatherstrips. Rubber has steel inserts just like the originals. Easy to install.

Includes the following items:

- 1 Header seal
- 2 Front roof rail strips
- 2 Center roof rail strips
- 2 Rear roof rail strips

|          |       |                       |           |     |
|----------|-------|-----------------------|-----------|-----|
| 62-06303 | 62-63 | Convertible . . . . . | \$ 329.00 | kit |
|----------|-------|-----------------------|-----------|-----|

\* The following items require additional shipping and handling.



# CHEVROLET NOVA PARTS



Car Shop Inc. 739 North Batavia Orange, California 92868

## COUPE WEATHERSTRIP KITS



### 1962-1967 2-door hardtop

Includes all of the following:

- 2 Door seals
- 2 Roof rail weatherstrip
- 1 Window felt kit
- 2 Quarter window vertical seals
- 2 U-Shaped door jamb rubber seals
- 1 Trunk weatherstrip
- 2 Vent window seals
- 2 Upper door window stops
- 2 Door glass vertical run channels

### With Original style window felt kit

|           |       |                |       |           |     |
|-----------|-------|----------------|-------|-----------|-----|
| 62-063051 | 62-64 | 2-door hardtop | ..... | \$ 345.00 | kit |
| 65-063051 | 65    | 2-door hardtop | ..... | \$ 333.00 | kit |
| 66-063051 | 66-67 | 2-door hardtop | ..... | \$ 364.00 | kit |

### With replacement style window felt kit

|          |       |                |       |           |     |
|----------|-------|----------------|-------|-----------|-----|
| 66-06305 | 66-67 | 2-door hardtop | ..... | \$ 329.00 | kit |
|----------|-------|----------------|-------|-----------|-----|

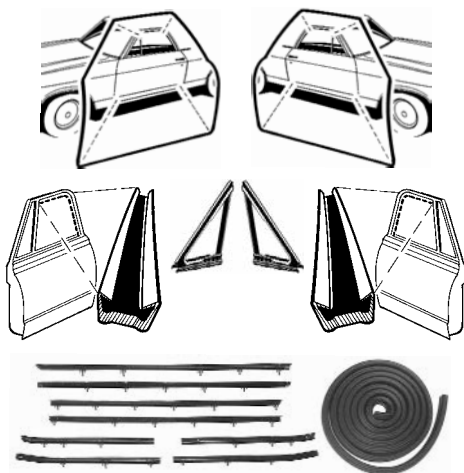

### 1968-1974 2-door sedan

Includes all of the following:

- 2 Door weatherstrips
- 1 Window felt kit (original style)
- 2 Glass frame weatherstrips
- 1 Trunk Weatherstrip
- 2 Vent window seals

|           |       |              |       |           |     |
|-----------|-------|--------------|-------|-----------|-----|
| 68-063051 | 68-72 | 2-door sedan | ..... | \$ 259.00 | kit |
|-----------|-------|--------------|-------|-----------|-----|

Without vent window seals

|           |       |              |       |           |     |
|-----------|-------|--------------|-------|-----------|-----|
| 68-063052 | 68-72 | 2-door sedan | ..... | \$ 190.00 | kit |
|-----------|-------|--------------|-------|-----------|-----|

## CONVERTIBLE WEATHERSTRIP KIT

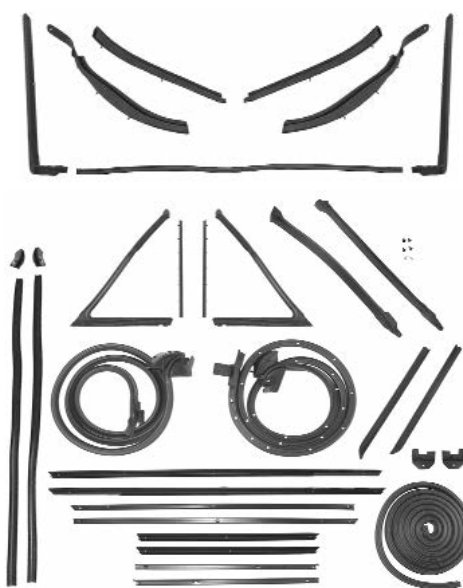

### 1962-1963 Convertible

Includes all of the following:

- 1 Convertible top roof rail weatherstrip kit with header seal
- 2 Door seals
- 2 Pillar post weatherstrip
- 1 Window felt kit (original style)
- 2 Quarter window vertical seals
- 2 U-Shaped door jamb rubber seals
- 1 Trunk weatherstrip
- 2 Vent window seals
- 2 Upper door window stops
- 2 Door glass vertical run channels

|           |       |             |       |           |     |
|-----------|-------|-------------|-------|-----------|-----|
| 62-063091 | 62-63 | Convertible | ..... | \$ 655.00 | kit |
|-----------|-------|-------------|-------|-----------|-----|

## PAINT SEAL GASKET SET

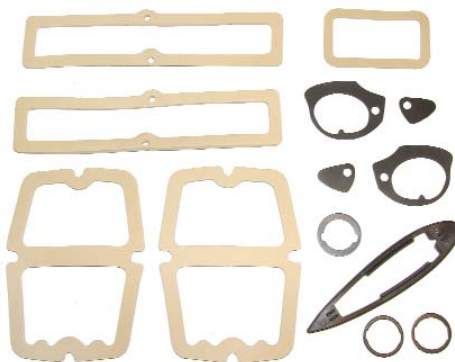

### New improved paint seal kits!

Reproduced from die-cut sponge rubber, correct color gaskets, not all black like other kits on the market!

|          |       |       |          |     |
|----------|-------|-------|----------|-----|
| 62-06313 | 62-64 | ..... | \$ 16.00 | kit |
| 65-06314 | 65    | ..... | \$ 16.00 | kit |
| 66-06315 | 66-67 | ..... | \$ 17.00 | kit |
| 68-06316 | 68-69 | ..... | \$ 16.00 | kit |
| 70-06317 | 70-71 | ..... | \$ 16.00 | kit |
| 77-06318 | 72    | ..... | \$ 16.00 | kit |

• CAR SHOP • BEST QUALITY! •  
• BEST PRICE! •

## REAR BUMPER TO BODY SEAL



|          |       |       |          |     |
|----------|-------|-------|----------|-----|
| 62-06350 | 62-65 | ..... | \$ 18.00 | ea. |
|----------|-------|-------|----------|-----|



|          |       |       |          |     |
|----------|-------|-------|----------|-----|
| 68-06350 | 68-72 | ..... | \$ 19.00 | ea. |
|----------|-------|-------|----------|-----|

## STATION WAGON TAILGATE WEATHERSTRIP



|          |       |       |          |     |
|----------|-------|-------|----------|-----|
| 62-06360 | 62-67 | ..... | \$ 99.00 | ea. |
|----------|-------|-------|----------|-----|

## DOOR BUMPERS



|          |       |              |       |         |     |
|----------|-------|--------------|-------|---------|-----|
| 64-04505 | 62-67 | Door bumpers | ..... | \$ 6.00 | set |
|----------|-------|--------------|-------|---------|-----|



|          |       |              |       |         |     |
|----------|-------|--------------|-------|---------|-----|
| 68-06401 | 68-79 | Door bumpers | ..... | \$ 5.00 | set |
|----------|-------|--------------|-------|---------|-----|

## GLOVE BOX BUMPERS



|          |       |                |       |         |     |
|----------|-------|----------------|-------|---------|-----|
| 67-04219 | 62-79 | Glove box door | ..... | \$ 1.50 | pr. |
|----------|-------|----------------|-------|---------|-----|



|          |       |               |       |         |     |
|----------|-------|---------------|-------|---------|-----|
| 67-06404 | 62-74 | Glove box arm | ..... | \$ 2.00 | ea. |
|----------|-------|---------------|-------|---------|-----|

## TRUNK BUMPERS



|          |       |       |       |         |     |
|----------|-------|-------|-------|---------|-----|
| 67-06406 | 62-74 | Trunk | ..... | \$ 3.00 | pr. |
|----------|-------|-------|-------|---------|-----|

+ The following items require additional shipping and handling.

Fax Order 1-714-771-0407 • Toll Free 1-800-235-2470 • [www.TruckandCarShop.com](http://www.TruckandCarShop.com) • 2014 Catalog



# CHEVROLET NOVA PARTS

Car Shop Inc. 739 North Batavia Orange, California 92868

## HOOD SIDE BUMPERS



62-06408 62-65 .....\$ 5.00 set



66-06408 66-67 .....\$ 6.00 set



68-06408 68-72 .....\$ 6.00 set

## FENDER TO COWL GRILL PANEL BUMPERS



62-06415 62-65 .....\$ 6.00 pr.

## TAILGATE BUMPERS



Replaces factory #4749999

62-06409 62-67 "L" shape .....\$ 10.00 ea.



Replaces factory #4767729

62-06410 62-67 mounts in latch .....\$ 4.00 ea.

## RUBBER BUMPER KIT



Most kits includes: Door, trunk, hood, side of fender, gas tank door and glove box bumpers.

62-06417 62-65 2-door hardtop .....\$ 14.00 kit

66-06417 66-67 2-door hardtop .....\$ 14.00 kit

68-06417 68-74 2-door hardtop .....\$ 14.00 kit

## HOOD STOP BOLTS & BUMPERS



These are the screw head bolts that thread into the radiator core support. Rubber bumpers slip over the top of these bolts.

67-06415 62-79 Bolt and bumper kit, Original style .....\$ 6.00 set



67-06413 62-79 Front rubber bumpers ..\$ 3.00 pr.

## SHEET METAL PLASTIC HOLE PLUGS



67-06330 fits 1/2" hole .....\$ .50 ea.

67-06331 fits 3/4" hole .....\$ .50 ea.

67-06332 fits 7/8" hole .....\$ .50 ea.

67-06333 fits 1" hole .....\$ .50 ea.

67-06334 fits 1-1/4" hole .....\$ .50 ea.

67-06335 fits 1-1/2" hole .....\$ .50 ea.

## RUBBER GROMMETS



62-06370 fits 1/2" hole .....\$ 2.00 ea.

62-06371 fits 5/8" hole .....\$ 2.00 ea.

62-06372 fits 3/4" hole, thin groove .....\$ 1.50 ea.

62-06373 fits 3/4" hole, thick groove .....\$ 2.00 ea.

62-06374 fits 1" hole .....\$ 2.00 ea.

## WIRING GROMMETS



Grommet, wiring through rear quarter panel or tailgate.

62-06365 62-67 .....\$ 16.00 ea.

## A-ARM SPLASH FLAPS

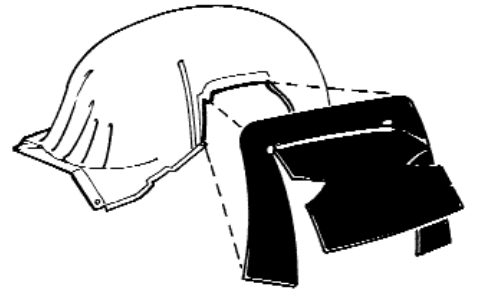

These rubber flaps connect to the inner front fenders to hide the control arm shafts. They do an excellent job of keeping water, dirt, etc... out of your engine compartment.

68-06410 68 .....\$ 15.00 set

69-06410 69 .....\$ 16.00 set

70-06410 70-74 .....\$ 16.00 set

## BODY SEALER

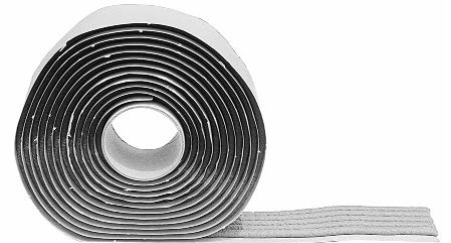

Five 13 foot strips.

67-06340 62-74 .....\$ 20.00 kit

## MASTIC SEALER WASHERS



Disc shaped sealer washers used on emblem nuts & molding clips.

67-06341 .16 x .44 x.06 TK, 25 pieces ...\$ 4.50 kit

67-06342 .16 x .50 x.07 TK, 25 pieces ...\$ 4.50 kit

67-06343 .22 x .62 x.12 TK, 20 pieces ...\$ 4.50 kit

67-06344 .25 x .80 x.12 TK, 12 pieces ...\$ 4.50 kit

67-06345 .40 x .1.82 x.15 TK, 4 pieces ...\$ 4.50 kit

## GLASS SETTING TAPE



Fits between glass and channels.

58-04115 58-72 .031 x 1.5" .....\$ .50 ft.

58-04116 58-72 .047 x 1.5" .....\$ .50 ft.

58-04117 58-72 .063 x 1.5" .....\$ .50 ft.

58-04118 58-72 .031 x 1.5", cork style ..\$ .50 ft.

58-04119 58-72 .063 x 1.5", cork style ..\$ .50 ft.

# CHEVROLET NOVA PARTS



Car Shop Inc. 739 North Batavia Orange, California 92868

## GLASS SETS

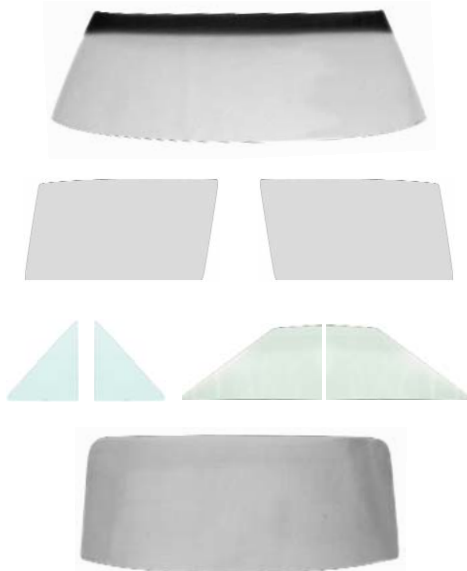

### Fits 1962 2 door hardtop.

Complete 8 piece Glass Package Includes: Windshield, Rear Window 2 vents, 2 doors and 2 quarters.

- 62-06360 ▲ 62 8-pc. clear . . . . . \$ 549.00 set  
62-06361 ▲ 62 8-pc. tinted . . . . . \$ 559.00 set

### Fits 1963-1965 2 door hardtop.

Complete 8 piece Glass Package Includes: Windshield, Rear Window 2 vents, 2 doors and 2 quarters.

- 63-06360 ▲ 63-65 8-pc. clear . . . . . \$ 549.00 set  
63-06361 ▲ 63-65 8-pc. tinted . . . . . \$ 559.00 set

### Fits 1966-1967 2 door hardtop.

Complete 8 piece Glass Package Includes: Windshield, Rear Window 2 vents, 2 doors and 2 quarters.

- 66-06360 ▲ 66-67 8-pc. clear . . . . . \$ 549.00 set  
66-06361 ▲ 66-67 8-pc. tinted . . . . . \$ 559.00 set

### Fits 1968-1969 2 door sedan.

Complete 8 piece Glass Package Includes: Windshield, Rear Window 2 vents, 2 doors and 2 quarters. **Without** antenna in glass

- 68-06362 ▲ 68-69 8-pc. clear . . . . . \$ 749.00 set  
68-06363 ▲ 68-69 8-pc. tinted . . . . . \$ 749.00 set

### Fits 1970-1972 2 door sedan.

Complete 8 piece Glass Package Includes: Windshield, Rear Window 2 vents, 2 doors and 2 quarters. **With** antenna in glass

- 70-06362 ▲ 70-72 8-pc. clear . . . . . \$ 749.00 set  
70-06363 ▲ 70-72 8-pc. tinted . . . . . \$ 749.00 set



## SIDE GLASS SETS

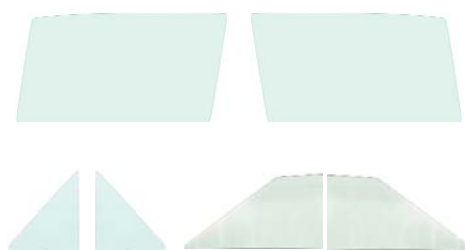

### Fits 1962 2 door hardtop.

6-piece Side Glass Kit Includes: 2 vents, 2 doors and 2 quarters.

- 62-06370+ 62 6-pc. clear . . . . . \$ 259.00 set  
62-06371+ 62 6-pc. tinted . . . . . \$ 259.00 set

### Fits 1963-1965 2 door hardtop.

6-piece Side Glass Kit Includes: 2 vents, 2 doors and 2 quarters.

- 63-06370+ 63-65 6-pc. clear . . . . . \$ 259.00 set  
63-06371+ 63-65 6-pc. tinted . . . . . \$ 259.00 set

### Fits 1966-1967 2 door hardtop.

6-piece Side Glass Kit Includes: 2 vents, 2 doors and 2 quarters.

- 66-06370+ 66-67 6-pc. clear . . . . . \$ 259.00 set  
66-06371+ 66-67 6-pc. tinted . . . . . \$ 259.00 set

### Fits 1968-1972 2 door sedan.

6-piece Side Glass Kit Includes: 2 vents, 2 doors and 2 quarters.

- 68-06372+ 68-72 6-pc. clear . . . . . \$ 449.00 set  
68-06373+ 68-72 6-pc. tinted . . . . . \$ 449.00 set

## VENT WINDOW GLASS



### Fits 1962 Convertible & 1962 hardtop, sedan, wagon.

- 62-06423 62 LH or RH, clear . . . . . \$ 36.00 ea.  
62-06425 62 LH or RH, tint . . . . . \$ 36.00 ea.

### Fits 1963 Convertible & 1963-1967 hardtop, sedan, wagon.

- 63-06423 63-67 LH or RH, clear . . . . . \$ 36.00 ea.  
63-06425 63-67 LH or RH, tint . . . . . \$ 36.00 ea.



### Fits 1968-1972 2 or 4 door sedan.

- 68-06423 68-72 LH, clear . . . . . \$ 52.00 ea.  
68-06424 68-72 RH, clear . . . . . \$ 52.00 ea.  
68-06425 68-72 LH, tinted . . . . . \$ 55.00 ea.  
68-06426 68-72 RH, tinted . . . . . \$ 55.00 ea.

## DOOR GLASS



### Fits 1962-1963 Convertible & 1962-1965 hardtop.

- 62-06427 62-65 LH or RH, clear . . . . . \$ 65.00 ea.  
62-06429 62-65 LH or RH, tint . . . . . \$ 65.00 ea.

### Fits 1966-1967 2 door hardtop.

- 66-06427 66-67 LH or RH, clear . . . . . \$ 65.00 ea.  
66-06429 66-67 LH or RH, tint . . . . . \$ 65.00 ea.

### Fits 1962-1967 2 door sedan.

- 62-06435 62-67 LH or RH, clear . . . . . \$ 65.00 ea.  
62-06437 62-67 LH or RH, tint . . . . . \$ 65.00 ea.

### Fits 1968-1972 2 door sedan.

- 68-06435 68-72 LH, clear . . . . . \$ 95.00 ea.  
68-06436 68-72 RH, clear . . . . . \$ 95.00 ea.  
68-06437 68-72 LH, tinted . . . . . \$ 95.00 ea.  
68-06438 68-72 RH, tinted . . . . . \$ 95.00 ea.

### Fits 1962-1967 4 door sedan & wagon front door glass.

- 62-064351 62-67 LH or RH, clear . . . . . \$ 65.00 ea.  
62-064352 62-67 LH or RH, tint . . . . . \$ 65.00 ea.

### Fits 1962-1965 4 door sedan rear door glass.

- 62-064353 62-65 LH or RH, clear . . . . . \$ 65.00 ea.  
62-064354 62-65 LH or RH, tint . . . . . \$ 65.00 ea.

### Fits 1962-1965 4 door sedan rear door glass.

- 66-064353 66-67 LH or RH, clear . . . . . \$ 65.00 ea.  
66-064354 66-67 LH or RH, tint . . . . . \$ 65.00 ea.

### Fits 1962-1967 4 door wagon rear door glass.

- 62-064355 62-67 LH or RH, clear . . . . . \$ 65.00 ea.  
62-064356 62-67 LH or RH, tint . . . . . \$ 65.00 ea.

## DOOR GLASS ASSEMBLY



- 66-06540+ 66-67 LH, clear . . . . . \$ 324.00 ea.  
66-06541+ 66-67 RH, clear . . . . . \$ 324.00 ea.

+ The following items require additional shipping and handling.

▲ The following items are not shippable.



# CHEVROLET NOVA PARTS

Car Shop Inc. 739 North Batavia Orange, California 92868

## QUARTER WINDOW GLASS

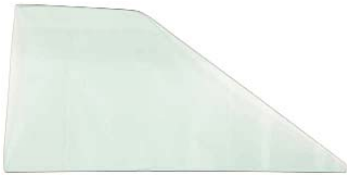

**Fits 1962-1963 Convertible.**

|          |    |                  |                    |
|----------|----|------------------|--------------------|
| 62-06505 | 62 | LH or RH, clear  | ..... \$ 59.00 ea. |
| 62-06507 | 62 | LH or RH, tinted | ..... \$ 59.00 ea. |
| 63-06505 | 63 | LH or RH, clear  | ..... \$ 59.00 ea. |
| 63-06507 | 63 | LH or RH, tinted | ..... \$ 59.00 ea. |

**Fits 1962-1965 2 door hardtop.**

|          |       |                  |                    |
|----------|-------|------------------|--------------------|
| 62-06501 | 62-65 | LH or RH, clear  | ..... \$ 59.00 ea. |
| 62-06503 | 62-65 | LH or RH, tinted | ..... \$ 59.00 ea. |

**Fits 1966-1967 2 door hardtop.**

|          |       |                  |                    |
|----------|-------|------------------|--------------------|
| 66-06501 | 66-67 | LH or RH, clear  | ..... \$ 59.00 ea. |
| 66-06503 | 66-67 | LH or RH, tinted | ..... \$ 59.00 ea. |

**Fits 1962-1965 2 door sedan.**

|          |       |                  |                    |
|----------|-------|------------------|--------------------|
| 62-06505 | 62-65 | LH or RH, clear  | ..... \$ 59.00 ea. |
| 62-06507 | 62-65 | LH or RH, tinted | ..... \$ 59.00 ea. |

**Fits 1966-1967 2 door sedan.**

|          |       |                  |                    |
|----------|-------|------------------|--------------------|
| 66-06505 | 66-67 | LH or RH, clear  | ..... \$ 59.00 ea. |
| 66-06507 | 66-67 | LH or RH, tinted | ..... \$ 59.00 ea. |



**Fits 1968-1972 2 door sedan.**

|          |       |            |                    |
|----------|-------|------------|--------------------|
| 68-06505 | 68-72 | LH, clear  | ..... \$ 76.00 ea. |
| 68-06506 | 68-72 | RH, clear  | ..... \$ 76.00 ea. |
| 68-06507 | 68-72 | LH, tinted | ..... \$ 79.00 ea. |
| 68-06508 | 68-72 | RH, tinted | ..... \$ 79.00 ea. |

## 4-DOOR REAR STATIONARY VENT WINDOW GLASS



**Fits 1962-1965 4 door sedan.**

|           |       |                  |                    |
|-----------|-------|------------------|--------------------|
| 62-065051 | 62-65 | LH or RH, clear  | ..... \$ 65.00 ea. |
| 62-065052 | 62-65 | LH or RH, tinted | ..... \$ 65.00 ea. |

**Fits 1966-1967 4 door sedan.**

|           |       |                  |                    |
|-----------|-------|------------------|--------------------|
| 66-065051 | 66-67 | LH or RH, clear  | ..... \$ 39.00 ea. |
| 66-065052 | 66-67 | LH or RH, tinted | ..... \$ 39.00 ea. |

## 4-DOOR REAR STATIONARY VENT WINDOW GLASS



**Fits 1962-1967 4 door station wagon.**

|           |       |                  |                    |
|-----------|-------|------------------|--------------------|
| 62-065053 | 62-67 | LH or RH, clear  | ..... \$ 39.00 ea. |
| 62-065054 | 62-67 | LH or RH, tinted | ..... \$ 39.00 ea. |

## WAGON REAR STATIONARY SIDE WINDOW GLASS



**Fits 1962-1967 4 door station wagon.**

|           |       |                  |                    |
|-----------|-------|------------------|--------------------|
| 62-065055 | 62-67 | LH or RH, clear  | ..... \$ 98.00 ea. |
| 62-065056 | 62-67 | LH or RH, tinted | ..... \$ 98.00 ea. |

## WINDSHIELD GLASS



**Fits 1962-1963 Convertible & 1962-1967 2 door hardtop.**

|          |       |                 |                     |
|----------|-------|-----------------|---------------------|
| 62-06509 | 62-67 | Clear           | ..... \$ 169.00 ea. |
| 62-06510 | 62-67 | Tinted & shaded | ..... \$ 159.00 ea. |

**1962-1967 2 or 4 door sedan/wagon.**

|          |       |                 |                     |
|----------|-------|-----------------|---------------------|
| 63-06509 | 62-67 | Clear           | ..... \$ 169.00 ea. |
| 63-06510 | 62-67 | Tinted & shaded | ..... \$ 159.00 ea. |



**1968-1969 2 door sedan, without antenna in glass.**

|          |       |                 |                     |
|----------|-------|-----------------|---------------------|
| 68-06509 | 68-69 | Clear           | ..... \$ 179.00 ea. |
| 68-06510 | 68-69 | Tinted & shaded | ..... \$ 159.00 ea. |

**1970-1972 2 door sedan, with antenna in glass.**

|          |       |                 |                     |
|----------|-------|-----------------|---------------------|
| 70-06509 | 70-72 | Clear           | ..... \$ 179.00 ea. |
| 70-06510 | 70-72 | Tinted & shaded | ..... \$ 159.00 ea. |

**1968-1972 4 door sedan, with antenna in glass.**

|          |       |                 |                     |
|----------|-------|-----------------|---------------------|
| 68-06511 | 68-72 | Tinted & shaded | ..... \$ 225.00 ea. |
|----------|-------|-----------------|---------------------|

## REAR GLASS



**1962-1965 2 door hardtop.**

|          |       |        |                     |
|----------|-------|--------|---------------------|
| 62-06512 | 62-65 | Clear  | ..... \$ 225.00 ea. |
| 62-06513 | 62-65 | Tinted | ..... \$ 225.00 ea. |

**1966-1967 2 door hardtop.**

|          |       |        |                     |
|----------|-------|--------|---------------------|
| 66-06512 | 66-67 | Clear  | ..... \$ 259.00 ea. |
| 66-06513 | 66-67 | Tinted | ..... \$ 259.00 ea. |



**1962-1964 2 or 4 door sedan.**

|          |       |        |                     |
|----------|-------|--------|---------------------|
| 62-06514 | 62-64 | Clear  | ..... \$ 259.00 ea. |
| 62-06515 | 62-64 | Tinted | ..... \$ 259.00 ea. |

**1965 2 or 4 door sedan.**

|          |    |        |                     |
|----------|----|--------|---------------------|
| 65-06514 | 65 | Clear  | ..... \$ 259.00 ea. |
| 65-06515 | 65 | Tinted | ..... \$ 259.00 ea. |

**1966-1967 2 or 4 door sedan.**

|          |       |        |                     |
|----------|-------|--------|---------------------|
| 66-06514 | 66-67 | Clear  | ..... \$ 239.00 ea. |
| 66-06515 | 66-67 | Tinted | ..... \$ 239.00 ea. |

**1968-1974 2 door sedan.**

|          |       |        |                     |
|----------|-------|--------|---------------------|
| 68-06514 | 68-74 | Clear  | ..... \$ 239.00 ea. |
| 68-06515 | 68-74 | Tinted | ..... \$ 239.00 ea. |

## STATION WAGON REAR GLASS



**1962-1967 4 door station wagon.**

|           |       |        |                     |
|-----------|-------|--------|---------------------|
| 62-065151 | 62-65 | Clear  | ..... \$ 149.00 ea. |
| 62-065152 | 62-65 | Tinted | ..... \$ 149.00 ea. |

+ The following items require additional shipping and handling.

▲ The following items are not shippable.

# CHEVROLET NOVA PARTS



Car Shop Inc. 739 North Batavia Orange, California 92868

## LICENSE PLATE LAMP ASSEMBLY



62-06516 62-65 .....\$ 41.00 ea.



Correct reproduction features correct GUIDE 3 SAE L 64 on lens and correct brown wire with grommet.

67-065161 66-72 .....\$ 19.00 ea.

## LICENSE PLATE LAMP LENSES

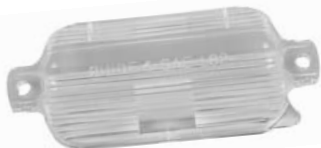

62-06517 62-65 .....\$ 16.00 ea.



67-06517 66-72 .....\$ 5.00 ea.

## LICENSE LENS GASKET



61-00930 62-65 .....\$ 3.00 ea.



67-06520 66-72 .....\$ 2.50 ea.

## SIDE MARKER LIGHT PIGTAIL



68-06526 68-79 .....\$ 4.00 ea.

## SIDE MARKER LIGHT GASKETS



68-06521 68-69 Lens to body, 4 pcs. ....\$ 4.00 kit



70-06521 70-74 Lens to body, 4 pcs. ....\$ 5.00 kit



For bezels without engine size.

68-06523 68-69 Bezel to body, 4 pcs. ....\$ 6.00 kit



For bezels with engine size.

68-047012 68-69 Bezel to fender, 2 pcs. ...\$ 7.00 pr.

## SIDE MARKER LIGHTS



Includes lens and housing.

68-06527 68 Front, clear .....\$ 7.00 ea.

69-06527 69 Front, amber .....\$ 7.00 ea.



70-06527 70-74 Front, amber .....\$ 38.00 pr.



68-06528 68-69 Rear, red .....\$ 7.00 ea.



70-06528 70-74 Rear, red .....\$ 38.00 pr.

## SIDE MARKER LIGHT BEZELS

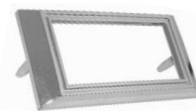

68-06605 68-69 Front or rear .....\$ 7.00 ea.



New chrome replacements that fit around the marker light lens.

68-01219 68-69 307 .....\$ 79.00 pr.

68-01220 68-69 327 .....\$ 79.00 pr.



68-01221 68-69 350 .....\$ 79.00 pr.



68-01222 68-69 396 .....\$ 79.00 pr.



68-01223 68-69 427, black .....\$ 79.00 pr.

68-01224 68-69 427, red .....\$ 92.00 pr.



70-06605 70-74 Front .....\$ 20.00 ea.

70-06606 70-79 Rear .....\$ 20.00 ea.

75-79 Front .....\$ 20.00 ea.

\* The following items require additional shipping and handling.

Fax Order 1-714-771-0407 • Toll Free 1-800-235-2470 • [www.TruckandCarShop.com](http://www.TruckandCarShop.com) • 2014 Catalog



# CHEVROLET NOVA PARTS

Car Shop Inc. 739 North Batavia Orange, California 92868

## PARKING LIGHT PIGTAIL



67-06624 62-64 LH or RH .....\$ 12.00 ea.

## PARKING LIGHT BEZELS

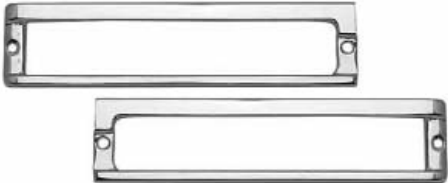

62-06710 62-64 LH & RH .....\$ 38.00 pr.

## PARKING LIGHT & BEZEL SCREW KIT



62-068105 62-64 8 pieces .....\$ 4.75 kit

## PARKING LIGHT LENS TRIM RING



This is the stainless steel trim ring that fits around the parking lenses.  
73-06710 73-74 LH or RH .....\$ 14.00 ea.

## PARK LIGHT LENS GASKETS



62-06614 62-64 .....\$ 5.00 pr.



65-06615 65-67 .....\$ 5.00 pr.



68-06615 68-69 .....\$ 5.00 pr.



70-06615 70-72 .....\$ 5.00 pr.

## PARKING LIGHT LENSES

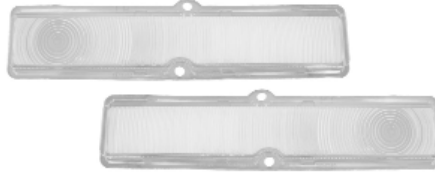

62-06701 62 LH & RH, clear .....\$ 25.00 pr.  
63-06701 63-64 LH & RH, amber .....\$ 19.00 pr.



65-06701 65 LH & RH, amber .....\$ 38.00 pr.  
66-06701 66-67 LH & RH, amber .....\$ 33.00 pr.  
66-06702 66-67 LH & RH, clear .....\$ 38.00 pr.



68-06701 68-69 LH & RH, amber  
made in USA .....\$ 35.00 pr.  
68-06702 68-69 LH & RH, amber  
import .....\$ 22.00 pr.



70-06701 70 LH & RH, clear  
made in USA .....\$ 35.00 pr.  
70-06702 70 LH & RH, clear  
import .....\$ 22.00 pr.



71-06701 71-72 LH & RH, amber  
made in USA .....\$ 35.00 pr.  
71-06702 71-72 LH & RH, amber  
import .....\$ 22.00 pr.



Lens assembly, includes housing & hardware.  
73-06701 73-74 LH or RH, amber .....\$ 29.00 ea.

## PARKING LIGHT ASSEMBLY



Features "guide" lens and correct color wiring.

62-06807 62 LH .....\$ 33.00 ea.  
62-06808 62 RH .....\$ 33.00 ea.  
63-06807 63-64 LH .....\$ 33.00 ea.  
63-06808 63-64 RH .....\$ 33.00 ea.



65-06807 65 LH .....\$ 51.00 ea.  
65-06808 65 RH .....\$ 51.00 ea.  
66-06807 66-67 LH .....\$ 51.00 ea.  
66-06808 66-67 RH .....\$ 51.00 ea.



68-06807 68-69 LH or RH .....\$ 51.00 ea.



70-06808 70 LH or RH, clear .....\$ 51.00 ea.  
71-06808 71-72 LH or RH, amber .....\$ 51.00 ea.

## PARK LIGHT HOUSING TO BUMPER SCREWS



10-24 x 1/2, with .37 external tooth washers.  
64-04850 67-72 4 pieces .....\$ 3.50 set

## PARKING LIGHT WIRE GROMMETS



67-06806 68-72 .....\$ 4.00 pr.

# CHEVROLET NOVA PARTS



Car Shop Inc. 739 North Batavia Orange, California 92868

## TAIL LIGHT BLUE DOTS



- 67-06915 "Blue Dots" plastic .....\$ 5.00 pr.  
 67-06916 "Blue Dots" glass .....\$ 6.00 pr.



- 67-069151 Blue dot drill bit .....\$ 16.00 ea.

## L.E.D. TAIL LIGHT LENSES



Does not fit station wagon.

- 62-06933 62-64 LH or RH, red .....\$ 38.00 ea.



- 67-06933 66-67 LH or RH, red .....\$ 35.00 ea.

## L.E.D. BACK-UP LIGHT LENSES



Does not fit station wagon.

- 62-06935 62-64 LH or RH, clear .....\$ 40.00 ea.



- 66-06935 66-67 LH or RH, clear .....\$ 36.00 ea.

## TAIL LIGHT LENSES



3 piece lens set, does one tail light. Does not fit station wagon.

- 62-06901 62-64 LH or RH, stock .....\$ 26.00 ea.



3 piece clear lens set, does one tail light. Does not fit station wagon.

- 62-06902 62-64 LH or RH, clear .....\$ 26.00 ea.



Station wagon 3 piece tail light lens set, does one tail light.

- 62-06903 62-64 LH or RH, wagon .....\$ 76.00 ea.



Does not fit station wagon.

- 65-06904 65 LH & RH, red .....\$ 54.00 pr.



Station wagon.

- 65-06905 65 LH & RH, red .....\$ 76.00 pr.

## TAIL LIGHT LENSES



- 66-06906 66-67 LH or RH, red .....\$ 15.00 ea.



- 66-06907 66-67 LH & RH, clear .....\$ 38.00 pr.



- 68-06907 68-69 LH & RH, red .....\$ 36.00 pr.



- 70-06908 70-71 LH .....\$ 34.00 ea.

- 70-06909 70-71 RH .....\$ 34.00 ea.

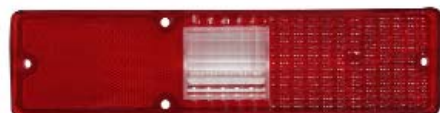

- 72-06908 72 LH .....\$ 34.00 ea.

- 72-06909 72 RH .....\$ 34.00 ea.



- 73-06908 73-74 LH .....\$ 89.00 ea.

- 73-06909 73-74 RH .....\$ 89.00 ea.

+ The following items require additional shipping and handling.



# CHEVROLET NOVA PARTS

Car Shop Inc. 739 North Batavia Orange, California 92868

## TAIL LIGHT LENS REFLECTOR



62-06900 62-64 LH & RH, red . . . . . \$ 10.00 pr.

## BACK-UP LIGHT LENSES

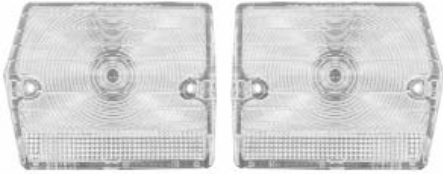

65-07007 65 LH & RH, clear . . . . . \$ 54.00 pr.



66-07008 66-67 LH or RH, clear . . . . . \$ 10.00 ea.



68-07009 68-69 LH or RH, clear . . . . . \$ 19.00 pr.

## TAIL LIGHT HOUSINGS



73-06818 73-74 LH . . . . . \$ 79.00 ea.

73-06820 73-74 RH . . . . . \$ 79.00 ea.

## TAIL LIGHT MOUNTING NUT KIT



66-06820 66-69 6 pieces . . . . . \$ 3.50 kit

70-06820 70-72 8 pieces . . . . . \$ 4.00 kit



## TAIL LIGHT ASSEMBLIES



Does not fit station wagon.

66-06913 62-64 LH or RH . . . . . \$ 89.00 ea.



SHOW QUALITY, Made in USA.

66-06913 66-67 LH or RH . . . . . \$ 95.00 ea.



Features "guide" lens.

68-06913 68-69 LH . . . . . \$ 109.00 ea.

68-06914 68-69 RH . . . . . \$ 109.00 ea.



70-06913 70-71 LH . . . . . \$ 95.00 ea.

70-06914 70-71 RH . . . . . \$ 95.00 ea.



72-06913 72 LH . . . . . \$ 95.00 ea.

72-06914 72 RH . . . . . \$ 95.00 ea.

## TAIL LIGHT LENS GASKETS



62-06917 62-64 . . . . . \$ 5.00 pr.



Fits tail-light or back-up light, 2 pair per car. Except wagon.

65-06917 65 . . . . . \$ 5.00 pr.

Fits tail-light, station wagon only.

65-069171 65 wagon . . . . . \$ 7.00 pr.

Fits back-up light, station wagon only.

65-069172 65 wagon . . . . . \$ 7.00 pr.

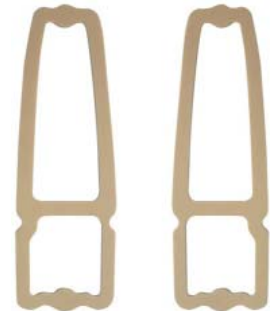

66-06917 66-67 . . . . . \$ 5.00 pr.



68-06917 68-69 . . . . . \$ 5.00 pr.



70-06917 70-71 . . . . . \$ 6.00 pr.

72-06917 72 . . . . . \$ 6.00 pr.

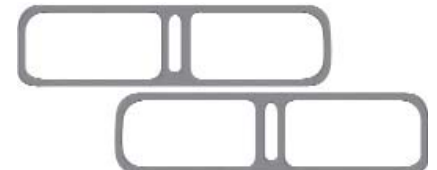

73-06917 73-74 LH & RH . . . . . \$ 24.00 pr.

+ The following items require additional shipping and handling.



# CHEVROLET NOVA PARTS



Car Shop Inc. 739 North Batavia Orange, California 92868

## TAIL LIGHT HOUSING TO BODY SEALS



62-06921 62-64 .....\$ 27.00 pr.



Fits tail-light & back-up light, molded as original. Except wagon.  
65-06921 65 4 pieces .....\$ 40.00 set



Fits tail-light, replacement foam seals. station wagon only.  
65-06922 65 inner .....\$ 6.00 pr.



66-06922 66-67 .....\$ 18.00 pr.



68-06922 68-69 .....\$ 14.00 pr.  
70-06922 70-72 .....\$ 18.00 pr.

## LENS SCREW KITS



8-32 x 13/16, chrome on stainless.  
64-04870 4 pieces .....\$ 4.00 set



8-32 x 1, chrome on stainless.  
64-04840 4 pieces .....\$ 4.00 set



8-32 x .712, with .302" shoulder, chrome on stainless.  
67-04860 4 pieces .....\$ 4.50 set



8-32 x .65, with .340" shoulder, chrome on stainless.  
68-04861 4 pieces .....\$ 4.50 set



8-32 x 3/4, with .435" shoulder, chrome on stainless.  
66-04871 4 pieces .....\$ 4.50 set



8-32 x 7/8, with .488" shoulder, chrome on stainless.  
65-04841 4 pieces .....\$ 4.50 set



8-32 x 1 1/8, with .640" shoulder, chrome on stainless.  
67-04842 4 pieces .....\$ 4.50 set



8-32 x 1.29, with .915" shoulder, chrome on stainless.  
70-04844 4 pieces .....\$ 5.00 set

Truck Shop & Car Shop offers parts catalogs for:

- 1941-1957 Fullsize Chevrolet cars
- 1958-1972 Fullsize Chevrolet cars
- 1967-1981 Camaro
- 1964-1987 Chevelle / El Camino
- 1962-1974 Chevy II / Nova
- 1964-1973 Mustang
- 1947-1959 Chevrolet/GMC Truck
- 1960-1972 Chevrolet/GMC Truck
- 1973-1991 Chevrolet/GMC Truck
- 1948-1986 Ford Truck
- 1966-1986 Ford Bronco

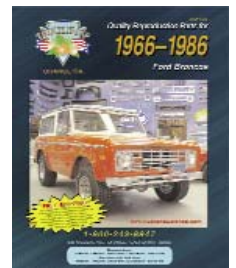
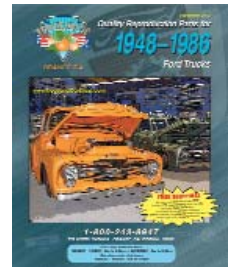
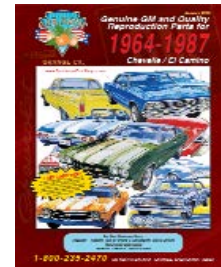
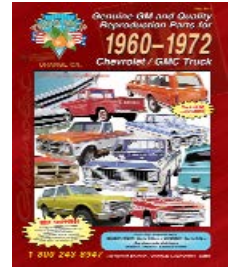
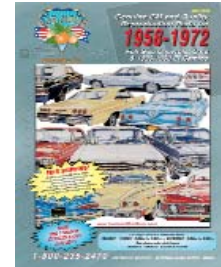

\* The following items require additional shipping and handling.

Fax Order 1-714-771-0407 • Toll Free 1-800-235-2470 • [www.TruckandCarShop.com](http://www.TruckandCarShop.com) • 2014 Catalog



# CHEVROLET NOVA PARTS

Car Shop Inc. 739 North Batavia Orange, California 92868

## GRILL EMBLEMS



66-07102 66 SS .....\$ 49.00 ea.



66-07103 66 Chevy II .....\$ 44.00 ea.



67-07103 67 Chevy II includes clips .....\$ 53.00 ea.



67-07104 67 emblem clips, for Chevy II emblem .....\$ 13.00 pr.



67-07105 67 Nova SS .....\$ 73.00 ea.



68-07108 68-69 SS .....\$ 25.00 ea.



70-07109 70-72 SS, made in USA .....\$ 56.00 ea.

70-07110 70-72 SS, import .....\$ 44.00 ea.



73-07108 73-74 SS .....\$ 49.00 ea.



73-07111 73-74 Bowtie .....\$ 78.00 ea.

## HOOD EMBLEMS



69-07212 69-72 front .....\$ 56.00 ea.



67-07213 "Cowl-Induction" (4 pc.) .....\$ 32.00 set

## FRONT FENDER EMBLEMS



63-01808 62-64 6-Cyl, black .....\$ 56.00 pr.

63-01809 62-64 6-Cyl, red .....\$ 56.00 pr.



64-07224 64 Nova - Chevy II .....\$ 89.00 pr.



64-07225 64 Nova SS .....\$ 66.00 pr.



Original for Chevy II with 283 engine.

62-01805 64 "V", 283 .....\$ 39.00 pr.

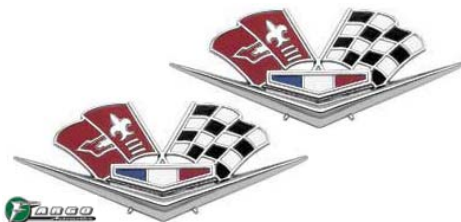

Original for Impalas with 327 engine, for custom applications. Mounts in the same holes as 283 style V-emblems without the flags.

62-01806 64 "V-flags" .....\$ 24.00 pr.

## FRONT FENDER EMBLEMS



64-05414 65-67 "230" .....\$ 24.00 ea.



67-07223 65-67 "327" .....\$ 15.00 pr.



67-07301 66-67 "350" .....\$ 15.00 pr.



67-07303 65-67 "V crossed flags" does both sides .....\$ 17.00 pr.



69-07330 69-72 "Nova", made in USA ...\$ 48.00 pr.



68-07314 68-69 "Yenko" .....\$ 32.00 ea.



69-07320 68-72 "250" .....\$ 55.00 pr.

\* The following items require additional shipping and handling.

# CHEVROLET NOVA PARTS



Car Shop Inc. 739 North Batavia Orange, California 92868

## FRONT FENDER EMBLEMS



69-07404 69 350 .....\$ 19.00 ea.



69-07407 69 Yenko style "427" with studs .....\$ 27.00 ea.

69-074071 69 Yenko style "427" stick on type .....\$ 23.00 ea.



69-07408 69 nickey .....\$ 59.00 ea.



73-05504 73-74 SS .....\$ 28.00 ea.



73-07412 73-74 Nova .....\$ 37.00 ea.

## FENDER LOUVER



68-07415 68-72 chrome .....\$ 29.00 ea.

## CUSTOM FENDER EMBLEMS



67-07501 "427", Red .....\$ 64.00 pr.



67-07502 "502" stick on, Red .....\$ 32.00 pr.

## QUARTER PANEL EMBLEMS



62-07460 62 Nova - 400 .....\$ 90.00 pr.



64-07224 63 Nova - Chevy II .....\$ 89.00 pr.



63-07461 63 Nova SS .....\$ 66.00 pr.



65-07461 65 Nova - Chevy II .....\$ 80.00 pr.



65-07462 65 Nova SS .....\$ 84.00 pr.



66-07463 66-67 Nova - Chevy II .....\$ 78.00 pr.



## QUARTER PANEL EMBLEMS



66-07464 66-67 Super Sport made in USA .....\$ 68.00 pr.



68-07465 68 Nova .....\$ 48.00 pr.

## TRUNK LID EMBLEMS



63-07503 63-64 Nova SS .....\$ 45.00 ea.



65-07504 65 Nova SS .....\$ 45.00 ea.



68-07505 68 Chevy II .....\$ 45.00 ea.



68-07504 68-72 Nova by Chevrolet .....\$ 29.00 ea.



73-05504 73-74 SS .....\$ 28.00 ea.

\* The following items require additional shipping and handling.

Fax Order 1-714-771-0407 • Toll Free 1-800-235-2470 • [www.TruckandCarShop.com](http://www.TruckandCarShop.com) • 2014 Catalog



# CHEVROLET NOVA PARTS

Car Shop Inc. 739 North Batavia Orange, California 92868

## REAR PANEL EMBLEMS



65-07506 65 Bow-Tie insert .....\$ 54.00 ea.



68-07506 68-69 SS, made in USA ....\$ 55.00 ea.

68-07507 68-69 SS, import .....\$ 42.00 ea.



70-07508 70-72 SS, made in USA ....\$ 55.00 ea.



69-07407 69 Yenko style" 427" with studs .....\$ 27.00 ea.

69-074071 69 Yenko style" 427" stick on type .....\$ 23.00 ea.



69-07408 69 nickey .....\$ 59.00 ea.

## REAR TRIM PANEL • REPLACEMENT STYLE



Made with the same new type plastic and chrome plating process that is used on new vehicles today.

68-07520 68-69 custom .....\$ 99.00 ea.



68-07521 68-69 SS .....\$ 109.00 ea.

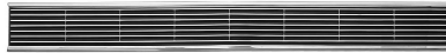

70-07522 70-72 custom .....\$ 99.00 ea.



70-07523 70-72 SS .....\$ 109.00 ea.

## REAR TRIM PANEL • ORIGINAL STYLE



Made from original GM tooling!  
Die cast as original, chrome with painted details.

70-07524 70-72 custom .....\$ 219.00 ea.



Made from original GM tooling!  
Die cast as original, chrome with painted details.

70-07525 70-72 SS .....\$ 215.00 ea.

## UNIVERSAL FENDER EMBLEM #' S

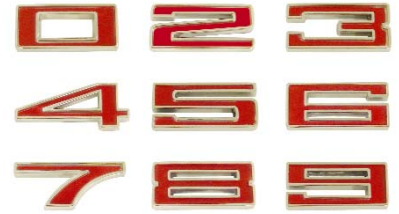

All numbers are supplied with self-adhesive backing with no holes to drill.

### White numbers

|          |     |                   |
|----------|-----|-------------------|
| 67-07418 | # 0 | .....\$ 16.00 ea. |
| 67-07419 | # 2 | .....\$ 16.00 ea. |
| 67-07420 | # 3 | .....\$ 16.00 ea. |
| 67-07421 | # 4 | .....\$ 16.00 ea. |
| 67-07422 | # 5 | .....\$ 16.00 ea. |
| 67-07423 | # 6 | .....\$ 16.00 ea. |
| 67-07424 | # 7 | .....\$ 16.00 ea. |
| 67-07425 | # 8 | .....\$ 16.00 ea. |
| 67-07426 | # 9 | .....\$ 16.00 ea. |

### Black numbers

|          |     |                   |
|----------|-----|-------------------|
| 67-07427 | # 0 | .....\$ 16.00 ea. |
| 67-07428 | # 2 | .....\$ 16.00 ea. |
| 67-07429 | # 3 | .....\$ 16.00 ea. |
| 67-07430 | # 4 | .....\$ 16.00 ea. |
| 67-07431 | # 5 | .....\$ 16.00 ea. |
| 67-07432 | # 6 | .....\$ 16.00 ea. |
| 67-07433 | # 7 | .....\$ 16.00 ea. |
| 67-07434 | # 8 | .....\$ 16.00 ea. |
| 67-07435 | # 9 | .....\$ 16.00 ea. |

### Red numbers

|          |     |                   |
|----------|-----|-------------------|
| 67-07436 | # 0 | .....\$ 16.00 ea. |
| 67-07437 | # 2 | .....\$ 16.00 ea. |
| 67-07438 | # 3 | .....\$ 16.00 ea. |
| 67-07439 | # 4 | .....\$ 16.00 ea. |
| 67-07440 | # 5 | .....\$ 16.00 ea. |
| 67-07441 | # 6 | .....\$ 16.00 ea. |
| 67-07442 | # 7 | .....\$ 16.00 ea. |
| 67-07443 | # 8 | .....\$ 16.00 ea. |
| 67-07444 | # 9 | .....\$ 16.00 ea. |

## REAR TRUNK PANEL



Die cast as original, chrome with painted details.

67-07521 67 SS .....Coming soon

• Car Shop •  
• Best Quality • Best Price •



+ The following items require additional shipping and handling.

# CHEVROLET NOVA PARTS



Car Shop Inc. 739 North Batavia Orange, California 92868

## BASIC EXTERIOR SCREW KITS



|          |       |           |          |     |
|----------|-------|-----------|----------|-----|
| 62-07550 | 62-64 | 41 screws | \$ 15.00 | kit |
| 65-07551 | 65    | 41 screws | \$ 15.00 | kit |
| 66-07552 | 66    | 39 screws | \$ 15.00 | kit |
| 67-07553 | 67    | 26 screws | \$ 11.00 | kit |
| 69-07554 | 69-70 | 22 screws | \$ 10.00 | kit |
| 71-07555 | 71-72 | 35 screws | \$ 13.00 | kit |
| 73-07556 | 73    | 26 screws | \$ 12.00 | kit |
| 73-07557 | 74    | 22 screws | \$ 9.00  | kit |

## HEADLIGHT BULB RETAINING RING



Secures the sealed beam to the headlamp housing.

|          |       |          |         |     |
|----------|-------|----------|---------|-----|
| 67-07630 | 62-74 | LH or RH | \$ 8.00 | ea. |
|----------|-------|----------|---------|-----|

## HEADLAMP RETAINING RING SCREWS



|           |       |                       |        |     |
|-----------|-------|-----------------------|--------|-----|
| 67-076305 | 62-79 | Retaining ring screws | \$ .15 | ea. |
|-----------|-------|-----------------------|--------|-----|



Original style, 8-32 x 5/16, .27 O.D., zinc plated, slotted head.

|           |       |          |         |     |
|-----------|-------|----------|---------|-----|
| 67-076306 | 62-79 | 6 pieces | \$ 3.00 | set |
|-----------|-------|----------|---------|-----|

## REPLACEMENT HEADLIGHT BULBS



|           |       |          |          |     |
|-----------|-------|----------|----------|-----|
| 67-07633  | 62-78 | standard | \$ 8.00  | ea. |
| 67-076331 | 62-78 | halogen  | \$ 12.00 | ea. |

## T-3 REPRODUCTION HEADLIGHT BULBS

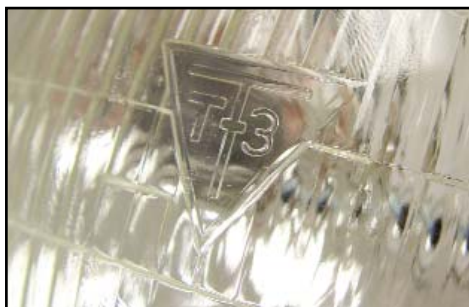

T-3 reproduction headlight bulbs.

|          |       |  |           |     |
|----------|-------|--|-----------|-----|
| 67-07632 | 62-69 |  | \$ 165.00 | pr. |
|----------|-------|--|-----------|-----|

## HEADLIGHT BULB PIGTAIL



|          |       |  |         |     |
|----------|-------|--|---------|-----|
| 67-07634 | 62-78 |  | \$ 3.00 | ea. |
|----------|-------|--|---------|-----|

## HEADLIGHT HOUSINGS



|          |    |    |          |     |
|----------|----|----|----------|-----|
| 66-07637 | 66 | LH | \$ 91.00 | ea. |
| 66-07638 | 66 | RH | \$ 91.00 | ea. |



|          |    |    |          |     |
|----------|----|----|----------|-----|
| 67-07639 | 67 | LH | \$ 91.00 | ea. |
| 67-07640 | 67 | RH | \$ 91.00 | ea. |

## HEADLIGHT BULB MOUNTING BUCKET



|          |       |    |          |     |
|----------|-------|----|----------|-----|
| 67-07635 | 66-67 | RH | \$ 21.00 | ea. |
|          | 68-74 | LH |          |     |
| 67-07636 | 66-67 | LH | \$ 21.00 | ea. |
|          | 68-74 | RH |          |     |

## FENDER HEADLIGHT MUDCAPS



|          |       |         |          |     |
|----------|-------|---------|----------|-----|
| 62-07665 | 62-65 | LH & RH | \$ 54.00 | pr. |
|----------|-------|---------|----------|-----|



|          |       |         |          |     |
|----------|-------|---------|----------|-----|
| 66-07666 | 66-67 | LH & RH | \$ 54.00 | pr. |
|----------|-------|---------|----------|-----|

## HEADLIGHT ASSEMBLY FASTENER KIT



|          |       |           |         |     |
|----------|-------|-----------|---------|-----|
| 62-07670 | 62-64 | 12 pieces | \$ 6.00 | kit |
|----------|-------|-----------|---------|-----|



|          |       |           |         |     |
|----------|-------|-----------|---------|-----|
| 66-07670 | 66-67 | 12 pieces | \$ 6.00 | kit |
|----------|-------|-----------|---------|-----|

+ The following items require additional shipping and handling.

Fax Order 1-714-771-0407 • Toll Free 1-800-235-2470 • [www.TruckandCarShop.com](http://www.TruckandCarShop.com) • 2014 Catalog



# CHEVROLET NOVA PARTS

Car Shop Inc. 739 North Batavia Orange, California 92868

## HEADLIGHT ADJUSTERS



67-07701 62-67 Adjuster nut .....\$ .50 ea.  
69-07702 68-74 Adjuster nut .....\$ .50 ea.



67-07703 Adjuster screw 1" .....\$ .50 ea.  
69-07704 Adjuster screw 1 1/2" .....\$ .50 ea.



 67-07705 62-74 Adjuster spring .....\$ 2.00 ea.

## HEADLIGHT ADJUSTER KIT



62-07660 62-67 10 pieces .....\$ 8.00 kit



68-07661 68-74 10 pieces .....\$ 8.50 kit

## HEADLIGHT BEZEL SCREWS



Universal kits, #8 x 3/4" with #6 head size, 8 pieces.  
67-07709 8 pcs, black .....\$ 2.00 set



69-07710 8 pcs, chrome .....\$ 2.00 set

## HEADLIGHT BEZEL SEALS



67-06235 67 .....\$ 9.00 pr.

## HEADLIGHT BEZELS



62-07712 62-64 LH & RH .....\$ 119.00 pr.



65-07715 65 LH or RH .....\$ 60.00 ea.



66-07719 66 made in USA .....\$ 118.00 ea.

66-07720 66 import .....\$ 74.00 ea.



67-07721 67 LH .....\$ 93.00 ea.

67-07722 67 RH .....\$ 93.00 ea.

## HEADLIGHT BEZELS



68-07723 68 LH & RH .....\$ 91.00 pr.



69-07724 69-72 LH & RH .....\$ 91.00 pr.

## HEADLIGHT BEZEL FASTENER KIT



62-07730 62-65 12 pcs .....\$ 5.00 kit



66-07730 66 16 pcs .....\$ 5.50 kit



67-077301 67 16 pcs .....\$ 5.50 kit

68-07730 68-69 20 pcs .....\$ 7.00 kit



70-07730 70-72 16 pcs .....\$ 6.00 kit

**Showroom hours:**  
TUESDAY - FRIDAY: 8:30AM to 4:30PM  
SATURDAY: 8:30AM to 3:30PM  
**Phone order desk hours:**  
MONDAY - FRIDAY: 8:30AM to 4:30PM

\* The following items require additional shipping and handling.

# CHEVROLET NOVA PARTS



Car Shop Inc. 739 North Batavia Orange, California 92868

## FENDER EYEBROW MOLDINGS



65-07730 65 LH & RH ..... \$ 179.00 pr.



68-07730 68-72 LH & RH, made in USA \$ 142.00 pr.  
68-07731 68-72 LH & RH, import ..... \$ 77.00 pr.

## PARK LIGHT EXTENSION MOLDINGS



62-07740 62-64 LH & RH ..... \$ 50.00 pr.

## GRILLS



Includes upper steel brace & 2 vertical braces riveted in place

62-07801 62 ..... \$ CALL ea.



Includes upper steel brace & 2 vertical braces riveted in place

63-07801 63 ..... \$ 239.00 ea.



Includes upper steel brace & 2 vertical braces riveted in place

64-07802 64 ..... \$ 239.00 ea.



65-07802 65 ..... \$ CALL ea.



66-07803 66 ..... \$ 138.00 ea.



67-07804 67 ..... \$ 140.00 ea.

## GRILLS

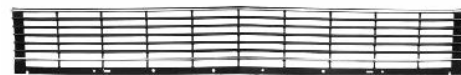

68-07805 68-69 exc SS, silver tips ..... \$ 119.00 ea.  
68-07806 68-69 SS, black tips ..... \$ 119.00 ea.



70-07807 70-72 exc SS, silver tips ..... \$ 119.00 ea.  
70-07808 70-72 SS, black tips ..... \$ 119.00 ea.



73-07809 73-74 SS painted ..... \$ 129.00 ea.

## HOOD SPLIT MOLDING



62-07840 62-64 ..... \$ 149.00 ea.

## FRONT HOOD MOLDING



66-07827 66 ..... \$ 42.00 ea.  
67-07827 67 ..... \$ 42.00 ea.



68-07827 68-72 made in USA ..... \$ 114.00 ea.  
68-07828 68-72 import ..... \$ 58.00 ea.  
73-07828 73-74 with clips ..... \$ 78.00 ea.

## GRILL MOLDINGS



66-07830 66 Lower ..... \$ 55.00 ea.

## GRILL BRACKET KIT



66-07843 66 6 pieces ..... \$ 28.00 kit



† The following items require additional shipping and handling.

Fax Order 1-714-771-0407 • Toll Free 1-800-235-2470 • [www.TruckandCarShop.com](http://www.TruckandCarShop.com) • 2014 Catalog



# CHEVROLET NOVA PARTS

Car Shop Inc. 739 North Batavia Orange, California 92868

## GRILL RIVETS



**Threaded style**, replaces original rivets, silver.  
67-07841 replacement .....\$ 0.75 ea.



**Original style**, flat top rivets.  
67-07842 13 pieces, black .....\$ 6.00 kit



**Original style**, rivets.  
62-07841 19 pieces, silver .....\$ 6.00 kit

## GRILL FASTENER KITS



64-07901 64 18 pieces .....\$ 9.00 kit  
65-07901 65 34 pieces .....\$ 9.50 kit  
66-07901 66 25 pieces .....\$ 9.50 kit



67-07901 67 24 pieces .....\$ 7.00 kit



**Grill & reinforcement fastener kit.**  
68-07902 68-69 26 pieces .....\$ 8.00 kit  
70-07901 70-72 24 pieces .....\$ 8.00 kit

## VINYL TOP MOLDINGS



68-06014 68-74 2-door .....\$ 139.00 set



68-06015 68-74 corner moldings .....\$ 62.00 pr.



68-023231 68-74 molding clip .....\$ 1.50 ea.

## WHEEL OPENING MOLDING SETS

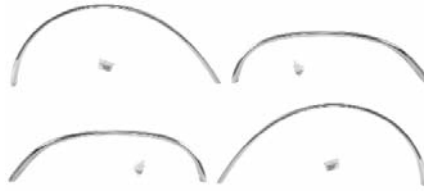

### 4-piece wheel opening molding sets

Includes mounting screws.  
Our wheel opening molding kit comes complete with all four wheel opening moldings and mounting screws. A must after a new paint job!  
62-08421+ 62-65 .....\$ 175.00 set



66-08421+ 66-67 .....\$ 175.00 set



68-08421+ 68-72 .....\$ 175.00 set

## WHEEL OPENING MOLDINGS



### Front fender

Includes mounting screws.  
62-08401+ 62-65 LH, front .....\$ 45.00 ea.  
62-08402+ 62-65 RH, front .....\$ 45.00 ea.



66-08401+ 66-67 LH, front .....\$ 45.00 ea.  
66-08402+ 66-67 RH, front .....\$ 45.00 ea.



68-08401+ 68-72 LH, front .....\$ 45.00 ea.  
68-08402+ 68-72 RH, front .....\$ 45.00 ea.



### Rear quarter

Driver quality. Includes mounting screws.  
62-08409+ 62-65 LH, rear .....\$ 45.00 ea.  
62-08410+ 62-65 RH, rear .....\$ 45.00 ea.



66-08409+ 66-67 LH, rear .....\$ 45.00 ea.  
66-08410+ 66-67 RH, rear .....\$ 45.00 ea.



68-08409+ 68-72 LH, rear .....\$ 45.00 ea.  
68-08410+ 68-72 RH, rear .....\$ 45.00 ea.

+ The following items require additional shipping and handling.



# CHEVROLET NOVA PARTS



Car Shop Inc. 739 North Batavia Orange, California 92868

## WHEEL OPENING MOLDING SCREW KITS



Enough to install 4 wheel opening moldings.

67-08424 62-72 .....\$ 5.00 kit



Correct reproduction, with wax sealer applied to threads.

67-084241 62-72 32 pieces .....\$ 7.00 set

## ROCKER PANEL MOLDING CLIPS



Replaces original rail style retainers.

64-06326 62-72 .....\$ 2.00 ea.

## "SS" ROCKER PANEL MOLDINGS



Show quality sets of 1966 Nova Super Sport rocker moldings. This is a four piece set, 2 lower rocker moldings and 2 lower door moldings. These are factory style high polished aluminum.

66-08438+ 66 SS, rocker moldings  
LH & RH .....\$ 595.00 set



Show quality 1966 Nova Super Sport lower fender moldings. These are factory style high polished aluminum.

66-08439 66 SS, fender moldings  
LH & RH .....\$ 85.00 pr.

## "SS" LOWER BODY SIDE MOLDINGS



Show quality sets of 1967 Nova Super Sport lower body side moldings. This is a 10 piece set, includes hardware. These are factory style high polished aluminum.

67-08438+ 67 SS, lower molding set  
LH & RH .....\$ 695.00 set

## ROCKER PANEL MOLDINGS

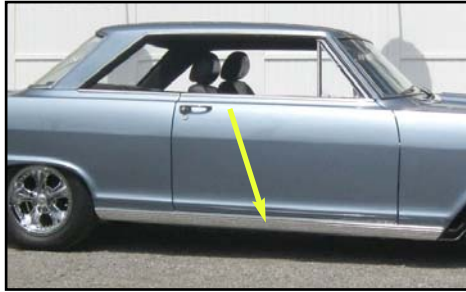

This is the aluminum strip that runs between the wheel openings below the door. Includes mounting hardware.

62-08451+ 62-63 LH & RH .....\$ 158.00 pr.



Includes mounting hardware.

66-08451+ 66-67 LH & RH .....\$ 128.00 pr.



Includes mounting hardware.

68-08452+ 68-74 LH & RH .....\$ 128.00 pr.

## ROCKER PANEL MOLDING EXTENSIONS



Includes mounting hardware.

68-08455 68-74 LH & RH .....\$ 72.00 pr.

## LOWER BODY SIDE MOLDING KIT



68-08460+ 68-74 LH & RH, 8 pieces ...\$ 170.00 kit

### Showroom hours:

**TUESDAY - FRIDAY: 8:30AM to 4:30PM**

**SATURDAY: 8:30AM to 3:30PM**

(Showroom closed Sunday & Monday)

### Phone order desk hours:

**MONDAY - FRIDAY: 8:30AM to 4:30PM**

**ORDER TOLL FREE: 1-800-235-2470**

**24 HOUR FAX: 714-771-0407**



+ The following items require additional shipping and handling.

Fax Order 1-714-771-0407 • Toll Free 1-800-235-2470 • [www.TruckandCarShop.com](http://www.TruckandCarShop.com) • 2014 Catalog



# CHEVROLET NOVA PARTS

Car Shop Inc. 739 North Batavia Orange, California 92868

## ROOF DRIP MOLDINGS



62-08508 62-65 2-door hardtop . . . . . \$ 85.00 kit



66-08508 66-67 2-door hardtop . . . . . \$ 79.00 kit



68-08508 68-72 2-door sedan . . . . . \$ 156.00 kit

73-08508 73-74 2-door sedan . . . . . \$ 140.00 kit

## ROOF DRIP CONNECTORS

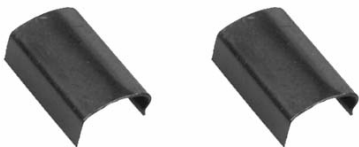

Stamped steel with black paint finish. Connects windshield drip pillar to roof drip, for cars without roof drip chrome.

68-08520 68-72 . . . . . \$ 16.00 pr.

## QUARTER WINDOW CORNER MOLDINGS

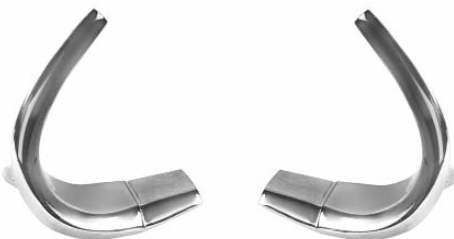

66-08550 66-67 show quality . . . . . \$ 68.00 pr.

66-08551 66-67 driver quality . . . . . \$ 38.00 pr.

## "SS" BODY SIDE PEAK MOLDINGS



8-piece body side peak molding kit, includes clips.

63-08536 63-64 8 pieces . . . . . \$ 309.00 kit

Includes clips.

63-08530 63-64 LH, fender . . . . . \$ 69.00 ea.

63-08531 63-64 RH, fender . . . . . \$ 69.00 ea.

Includes clips.

63-08532 63-64 LH, door . . . . . \$ 42.00 ea.

63-08533 63-64 RH, door . . . . . \$ 42.00 ea.

Includes upper & lower with clips.

63-08534+ 63-64 LH, quarter . . . . . \$ 70.00 ea.

63-08535+ 63-64 RH, quarter . . . . . \$ 70.00 ea.

## BODY SIDE MOLDINGS



6-piece body side molding kit, includes clips.

69-08536 69-72 6 piece kit . . . . . \$ 195.00 kit

Includes clips.

69-08530 69-72 LH, fender . . . . . \$ 39.00 ea.

69-08531 69-72 RH, fender . . . . . \$ 39.00 ea.

Includes clips.

69-08532 69-72 LH, door . . . . . \$ 35.00 ea.

69-08533 69-72 RH, door . . . . . \$ 35.00 ea.

Includes clips.

69-08534+ 69-72 LH or RH, quarter . . . . \$ 42.00 ea.

## TRUNK LID MOLDING



Includes clips.

62-08560 62-65 upper . . . . . \$ 44.00 ea.

## REAR COVE PANEL MOLDINGS



Includes clips.

62-08562 62-65 LH & RH . . . . . \$ 76.00 pr.

## TRUNK LID & COVE PANEL MOLDING KIT



Includes clips.

62-08564 62-65 3 pieces . . . . . \$ 116.00 kit

## DOOR FRAME MOLDING KITS



2-door sedan door & quarter window frame molding kit.

68-08570 68-72 LH & RH, 8 pieces . . . . \$ 235.00 kit



+ The following items require additional shipping and handling.

# CHEVROLET NOVA PARTS



Car Shop Inc. 739 North Batavia Orange, California 92868

## DOOR GLASS WINDOW FRAMES



62-08460 62-63 Convertible, LH & RH  
62-65 Coupe, LH & RH . . . . \$ 105.00 pr.

## 1/4 GLASS WINDOW FRAMES



62-08465 62-65 Coupe, LH & RH . . . . \$ 69.00 pr.  
62-08466 62-63 Convertible, LH & RH . . . \$ 82.00 pr.

## 1/4 WINDOW GLASS VERTICAL MOLDINGS



Attaches to the front of the quarter window glass. 2-door coupe.  
66-08505 66-67 LH & RH . . . . . \$ 66.00 pr.

## FRONT WINDSHIELD MOLDING KITS



Front windshield molding kits  
62-08601 62-67 2-door hardtop . . . . \$ 139.00 kit



62-08602 62-67 2-door sedan . . . . . \$ 149.00 kit



68-08604 68-74 2-door sedan . . . . . \$ 124.00 kit

## REAR WINDOW MOLDING KITS



Rear window molding kits  
62-08623 62-65 2-door hardtop, 8 pcs . . \$ 165.00 kit  
66-08624 66-67 2-door hardtop, 5 pcs . . \$ 165.00 kit

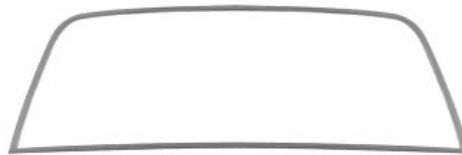

68-08624 68-74 2-door sedan, 5 pcs . . . \$ 135.00 kit

## CONCOURSE WINDOW MOLDING KITS



• Concourse correct reproduction •  
OE gauge, exact fit. Original material and superior quality workmanship gives a factory original appearance.

Front windshield molding kit  
68-08608 68-74 2-door sedan . . . . . Coming soon

Rear window molding kit  
68-08629 68-74 2-door sedan, 5 pcs . . . Coming soon

## FRONT WINDOW MOLDING CLIP KITS



Includes all of the clips on the upper and side front reveal moldings.  
68-08637 68-72 13 pieces . . . . . \$ 8.00 kit



73-08637 73-76 14 pieces . . . . . \$ 9.00 kit



Includes 8 of the lower front reveal molding clips.  
68-08639 68-74 8 pieces . . . . . \$ 19.00 kit

## FRONT WINDOW LOWER SUPPORT CLIP



Lower glass support clip.  
67-08640 68-79 . . . . . \$ 4.50 ea.

## REAR WINDOW MOLDING CLIPS



62-08641 62-65 each . . . . . \$ 2.25 ea.



62-08642 62-65 28 pieces . . . . . \$ 48.00 kit



Complete set of the original style clips used to install the rear window reveal moldings.

66-08641 66-67 25 pieces . . . . . \$ 9.00 kit

68-08641 68-72 14 pieces . . . . . \$ 8.00 kit

73-08641 73-74 18 pieces . . . . . \$ 8.00 kit

## WINDOW REVEAL MOLDING CLIPS



70-086422 screw on type . . . . . \$ .75 ea.

## WINDOW MOLDING PIN STUDS



Window and body molding retaining clip repair studs. Set of 10 studs. Replace commonly broken or rusted out studs with ease. Phillips head.  
67-086421 66-74 10 pieces . . . . . \$ 4.00 set

## WINDOW MOLDING REMOVAL TOOL



This handy tool removes the reveal moldings from the retaining clips.  
67-08643 66-74 . . . . . \$ 10.00 kit

† The following items require additional shipping and handling.

Fax Order 1-714-771-0407 • Toll Free 1-800-235-2470 • [www.TruckandCarShop.com](http://www.TruckandCarShop.com) • 2014 Catalog



# CHEVROLET NOVA PARTS

Car Shop Inc. 739 North Batavia Orange, California 92868

## MASTIC SEALER WASHERS



Disc shaped sealer washers used on emblem nuts & molding clips.

|          |                               |     |         |     |
|----------|-------------------------------|-----|---------|-----|
| 67-06341 | .16 x .44 x.06 TK, 25 pieces  | ... | \$ 4.50 | kit |
| 67-06342 | .16 x .50 x.07 TK, 25 pieces  | ... | \$ 4.50 | kit |
| 67-06343 | .22 x .62 x.12 TK, 20 pieces  | ... | \$ 4.50 | kit |
| 67-06344 | .25 x .80 x.12 TK, 12 pieces  | ... | \$ 4.50 | kit |
| 67-06345 | .40 x .1.82 x.15 TK, 4 pieces | ... | \$ 4.50 | kit |

## UNIVERSAL MOLDING CLIPS



#8-32 thread size

|          |           |     |         |     |
|----------|-----------|-----|---------|-----|
| 62-19824 | 3/4" long | ... | \$ 1.50 | ea. |
|----------|-----------|-----|---------|-----|



#10-24 thread size

|          |                            |     |         |     |
|----------|----------------------------|-----|---------|-----|
| 67-19824 | 3/4" long                  | ... | \$ .50  | ea. |
| 67-19823 | 1" long                    | ... | \$ .50  | ea. |
| 67-19822 | 1-1/4" long                | ... | \$ .50  | ea. |
| 67-19821 | 1-3/8" long                | ... | \$ .60  | ea. |
| 67-19820 | 1-5/8" long w/sliding stud | ... | \$ 1.50 | ea. |

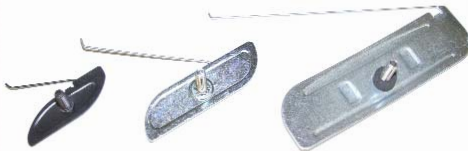

|          |             |     |         |     |
|----------|-------------|-----|---------|-----|
| 67-19819 | 1-7/8" long | ... | \$ .60  | ea. |
| 67-19818 | 2-1/2" long | ... | \$ 1.00 | ea. |
| 67-19817 | 4" long     | ... | \$ 2.00 | ea. |

## MOLDING CLIP NUTS



|          |                               |     |        |     |
|----------|-------------------------------|-----|--------|-----|
| 62-19825 | #8-32 nut, 1/2" washer head   | ... | \$ .20 | ea. |
| 67-19825 | #10-24 nut, 1/2" washer head  | ... | \$ .20 | ea. |
| 67-19826 | #10-24 nut, 3/4" washer head  | ... | \$ .20 | ea. |
| 67-19827 | #12-24 nut, 3/4" washer head  | ... | \$ .20 | ea. |
| 67-19828 | 1/4"-20 nut, 5/8" washer head | ... | \$ .20 | ea. |
| 67-19829 | 1/4"-20 nut, 7/8" washer head | ... | \$ .20 | ea. |



|           |  |     |        |     |
|-----------|--|-----|--------|-----|
| 67-198251 | #10-24 nut, 1/2" washer head with sealer | ... | \$ .25 | ea. |
|-----------|--|-----|--------|-----|

## FLAT HEX HEAD THREAD CUTTING NUTS



|          |                          |     |        |     |
|----------|--------------------------|-----|--------|-----|
| 62-19830 | 1/8" stud size, 1/4" hex | ... | \$ .20 | ea. |
| 62-19831 | 1/8" stud size, 3/8" hex | ... | \$ .20 | ea. |

## SELF LOCKING NUTS



|          |         |       |        |     |
|----------|---------|-------|--------|-----|
| 67-12798 | #10-24  | ..... | \$ .20 | ea. |
| 67-12799 | 1/4"-20 | ..... | \$ .20 | ea. |

## THREAD CUTTING NUTS



|          |                 |       |        |     |
|----------|-----------------|-------|--------|-----|
| 67-19830 | 1/8" stud size  | ..... | \$ .20 | ea. |
| 67-19831 | 5/32" stud size | ..... | \$ .20 | ea. |
| 67-19832 | 3/16" stud size | ..... | \$ .20 | ea. |
| 67-19833 | 1/4" stud size  | ..... | \$ .20 | ea. |
| 67-19834 | 5/16" stud size | ..... | \$ .20 | ea. |

## PUSH ON FLAT NUTS



|           |                 |       |        |     |
|-----------|-----------------|-------|--------|-----|
| 67-198351 | 1/16" stud size | ..... | \$ .20 | ea. |
| 67-19835  | 3/32" stud size | ..... | \$ .20 | ea. |
| 67-198352 | 1/8" stud size  | ..... | \$ .20 | ea. |
| 67-19836  | 5/32" stud size | ..... | \$ .20 | ea. |
| 67-19837  | 3/16" stud size | ..... | \$ .20 | ea. |
| 67-19838  | 5/16" stud size | ..... | \$ .20 | ea. |

## ROUND PUSH ON FLAT NUTS



|           |                 |       |        |     |
|-----------|-----------------|-------|--------|-----|
| 67-198381 | 1/8" stud size  | ..... | \$ .20 | ea. |
| 67-198382 | 5/32" stud size | ..... | \$ .20 | ea. |
| 67-198383 | 3/16" stud size | ..... | \$ .20 | ea. |

## BARREL NUTS



|          |                                      |       |        |     |
|----------|--------------------------------------|-------|--------|-----|
| 67-19860 | 1/8" stud size, 11/64" hole, plastic | ..... | \$ .30 | ea. |
| 67-19861 | 1/8" stud size, 5/32" hole           | ..... | \$ .25 | ea. |
| 67-19862 | 5/32" stud size, 7/32" hole          | ..... | \$ .25 | ea. |

## UNIVERSAL PUSH IN CLIPS (STEEL)



|          |                          |       |        |     |
|----------|--------------------------|-------|--------|-----|
| 67-19839 | 1-1/4" long              | ..... | \$ .50 | ea. |
| 67-19840 | 1-1/4" long w/top spacer | ..... | \$ .60 | ea. |

## UNIVERSAL PUSH IN CLIPS (PLASTIC)



|          |             |       |        |     |
|----------|-------------|-------|--------|-----|
| 67-19845 | 3/4" long   | ..... | \$ .50 | ea. |
| 67-19844 | 1" long     | ..... | \$ .50 | ea. |
| 67-19843 | 1-1/4" long | ..... | \$ .50 | ea. |
| 67-19842 | 1-3/8" long | ..... | \$ .50 | ea. |
| 67-19841 | 1-3/4" long | ..... | \$ .50 | ea. |

## UNIVERSAL BREAK OFF CLIPS



|          |                    |       |        |     |
|----------|--------------------|-------|--------|-----|
| 67-19846 | 3" plastic push in | ..... | \$ .75 | ea. |
| 67-19847 | 3" #10-24 thread   | ..... | \$ .75 | ea. |

## FRONT BUMPERS



|           |       |        |       |           |     |
|-----------|-------|--------|-------|-----------|-----|
| 62-08701+ | 62-64 | Chrome | ..... | \$ 159.00 | ea. |
| 65-08701+ | 65    | Chrome | ..... | \$ 159.00 | ea. |



|           |       |        |       |           |     |
|-----------|-------|--------|-------|-----------|-----|
| 66-08701+ | 66-67 | Chrome | ..... | \$ 169.00 | ea. |
|-----------|-------|--------|-------|-----------|-----|



|           |       |        |       |           |     |
|-----------|-------|--------|-------|-----------|-----|
| 68-08701+ | 68-69 | Chrome | ..... | \$ 189.00 | ea. |
|-----------|-------|--------|-------|-----------|-----|



|           |       |        |       |           |     |
|-----------|-------|--------|-------|-----------|-----|
| 70-08701+ | 70-72 | Chrome | ..... | \$ 189.00 | ea. |
|-----------|-------|--------|-------|-----------|-----|



+ The following items require additional shipping and handling.

# CHEVROLET NOVA PARTS



Car Shop Inc. 739 North Batavia Orange, California 92868

## REAR BUMPERS



62-08709+ 62-65 Chrome .....\$ 159.00 ea.



66-08709+ 66-67 Chrome .....\$ 169.00 ea.



68-08709+ 68-72 Chrome .....\$ 189.00 ea.

## FRONT GRILL GUARD



62-08713 62-65 chrome .....\$ 139.00 ea.

## FRONT BUMPER GUARDS



66-08713 66-67 chrome .....\$ 100.00 pr.

## BUMPER GUARD RETAINER



Replacement for some applications.

62-00701 62-65 rear .....\$ 9.00 ea.

## BUMPER GUARD BOLT KIT



1 kit mounts two bumper guards

67-08750 66-72 10 pieces .....\$ 4.50 kit

## REAR BUMPER GUARDS



66-08715 66-67 chrome .....\$ 119.00 pr.

## BUMPER GUARD RUBBER CUSHIONS



68-08722 68-72 Front .....\$ 34.00 pr.

68-08723 68-72 Rear .....\$ 34.00 pr.

## BUMPER BRACKETS, FRONT



62-08801 62-65 LH & RH, inner .....\$ 82.00 pr.



62-08802 62-65 LH & RH, outer .....\$ 82.00 pr.



66-08803 66-67 LH & RH, inner .....\$ 60.00 pr.



68-08803 68-72 LH inner & outer .....\$ 59.00 pr.

68-08804 68-72 RH inner & outer .....\$ 59.00 pr.

## BUMPER BRACKETS, REAR



62-08818 62-65 .....\$ 97.00 pr.



66-08820 66-67 LH .....\$ 42.00 ea.

66-08821 66-67 RH .....\$ 42.00 ea.



68-08822 68-72 LH .....\$ 34.00 ea.

68-08823 68-72 RH .....\$ 34.00 ea.

## FRONT BUMPER BRACKET BOLT KIT



Bumper bracket to frame bolt kit.

62-08840 62-65 10 pieces .....\$ 7.00 kit



66-08840 66-67 12 pieces .....\$ 7.00 kit



68-08840 68-72 16 pieces .....\$ 13.00 kit

+ The following items require additional shipping and handling.



# CHEVROLET NOVA PARTS

Car Shop Inc. 739 North Batavia Orange, California 92868

## REAR BUMPER BRACKET BOLT KIT



62-08848 62-65 18 pieces .....\$ 8.00 kit



66-08848 66-67 18 pieces .....\$ 7.00 kit



67-08848 68-72 8 pieces .....\$ 8.00 kit

## FRONT BUMPER MOUNTING KIT



62-08860 62-65 32 pieces .....\$ 13.00 kit



66-08860 66 24 pieces .....\$ 9.00 kit



67-08860 67 24 pieces .....\$ 9.00 kit

## FRONT BUMPER MOUNTING KIT

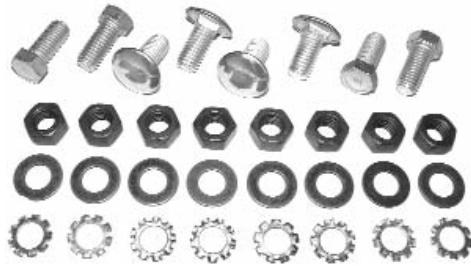

68-08860 68-72 32 pieces .....\$ 12.00 kit

## REAR BUMPER MOUNTING KIT



62-08865 62-65 30 pieces .....\$ 13.00 kit



66-08865 66 32 pieces .....\$ 11.00 kit



67-08865 67 32 pieces .....\$ 11.00 kit



68-08865 68-72 32 pieces .....\$ 12.00 kit

## STAINLESS CAPPED BUMPER BOLTS



Stainless steel capped.

64-06901 62-68 Dome top bolt and nut .....\$ 1.50 ea.

69-06902 67-72 Flat top bolt and nut .....\$ 1.50 ea.

## CHROME BUMPER BOLTS



Chrome.

64-06903 62-72 Dome top, bolt, nut & washers ...\$ 2.50 ea.

## REAR LICENSE BRACKET



69-08912 68-72 reproduction .....\$ 22.00 ea.

69-089121 68-72 GM .....\$ 49.00 ea.

70-08912 73-74 .....\$ 28.00 ea.

## REAR LICENSE PLATE BRACKET BOLT KIT



69-089122 68-72 2 pieces .....\$ 2.50 pr.

## LICENSE PLATE NUT & SCREW



67-08913 62-74 .....\$ 1.00 ea.

## LICENSE PLATE BUMPERS



62-06407 62-65 front or rear .....\$ 1.50 ea.



66-06407 66-67 rear .....\$ 1.50 ea.



67-06407 68-74 rear .....\$ 2.00 ea.

+ The following items require additional shipping and handling.

# CHEVROLET NOVA PARTS



Car Shop Inc. 739 North Batavia Orange, California 92868

## LICENSE PLATE FRAMES



Sold as a pair.

|          |    |      |          |     |
|----------|----|------|----------|-----|
| 62-08950 | 62 | Nova | \$ 15.00 | pr. |
| 63-08951 | 63 | Nova | \$ 15.00 | pr. |
| 64-08952 | 64 | Nova | \$ 15.00 | pr. |
| 65-08953 | 65 | Nova | \$ 15.00 | pr. |
| 66-08954 | 66 | Nova | \$ 15.00 | pr. |
| 67-08955 | 67 | Nova | \$ 15.00 | pr. |
| 68-08956 | 68 | Nova | \$ 15.00 | pr. |
| 69-08957 | 69 | Nova | \$ 15.00 | pr. |
| 70-08958 | 70 | Nova | \$ 15.00 | pr. |
| 71-08959 | 71 | Nova | \$ 15.00 | pr. |
| 72-08960 | 72 | Nova | \$ 15.00 | pr. |



Sold as a pair.

|          |    |           |          |     |
|----------|----|-----------|----------|-----|
| 62-14405 | 62 | Chevrolet | \$ 15.00 | pr. |
| 63-14405 | 63 | Chevrolet | \$ 15.00 | pr. |
| 64-14405 | 64 | Chevrolet | \$ 15.00 | pr. |
| 65-14408 | 65 | Chevrolet | \$ 15.00 | pr. |
| 66-14411 | 66 | Chevrolet | \$ 15.00 | pr. |
| 67-14414 | 67 | Chevrolet | \$ 15.00 | pr. |
| 68-14417 | 68 | Chevrolet | \$ 15.00 | pr. |
| 69-14420 | 69 | Chevrolet | \$ 15.00 | pr. |
| 70-14423 | 70 | Chevrolet | \$ 15.00 | pr. |
| 71-14426 | 71 | Chevrolet | \$ 15.00 | pr. |
| 72-14429 | 72 | Chevrolet | \$ 15.00 | pr. |

## STAINLESS STEEL LICENSE PLATES



67-08938 Face, stainless steel . . . . \$ 39.00 ea.

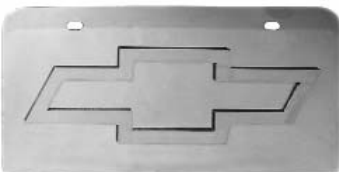

67-08939 Bow Tie, stainless steel . . . . \$ 39.00 ea.

## LICENSE PLATES



67-08929 The Heartbeat Of America, Chevrolet . . . . . \$ 9.00 ea.



67-08931 "Chevrolet USA-1" . . . . . \$ 9.00 ea.

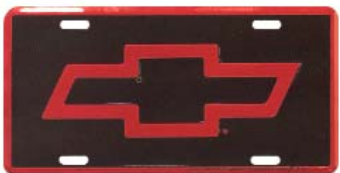

67-08940 Red Bow-Tie . . . . . \$ 9.00 ea.



67-08941 Kick'n' Asphalt . . . . . \$ 9.00 ea.

## LICENSE PLATE BULLET BOLTS



67-09001 License plate bullet bolts, Chrome (4 pcs.) . . . . . \$ 5.00 set

## CHROME LIGHTED LICENSE PLATE BOLTS



Available in various lens colors. 4 pc set.  
 67-09003 Amber . . . . . \$ 12.00 set  
 67-09004 Blue . . . . . \$ 12.00 set  
 67-09005 Green . . . . . \$ 12.00 set  
 67-09006 Red . . . . . \$ 12.00 set

## LIGHTED LICENSE PLATE BOLTS



LED license light bolts with stainless steel housing:  
 67-090061 White . . . . . \$ 12.00 pr.  
 67-090062 Amber . . . . . \$ 12.00 pr.  
 67-090063 Blue . . . . . \$ 12.00 pr.  
 67-090064 Red . . . . . \$ 12.00 pr.

## SPARE TIRE ANCHOR PLATE

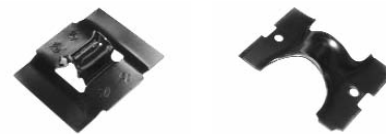

67-09007 62-72 . . . . . \$ 5.00 ea.  
 70-09008 70-74 . . . . . \$ 9.00 ea.

## SPARE TIRE ROD



67-09009 66-79 . . . . . \$ 6.00 ea.

## SPARE TIRE ROD WING NUT



67-09010 66-79 . . . . . \$ 5.00 ea.

## SPARE TIRE INFLATOR BOTTLE BRACKET



67-090101 68-74 . . . . . \$ 16.00 ea.

## BUMPER JACK



67-09011 67-70 Bumper jack, Cradle not included . . . \$ 119.00 kit

## LUG WRENCH



67-09015 62-74 GM . . . . . \$ 34.00 ea.

\* The following items require additional shipping and handling.



# CHEVROLET NOVA PARTS

Car Shop Inc. 739 North Batavia Orange, California 92868

## TRUNK MATS

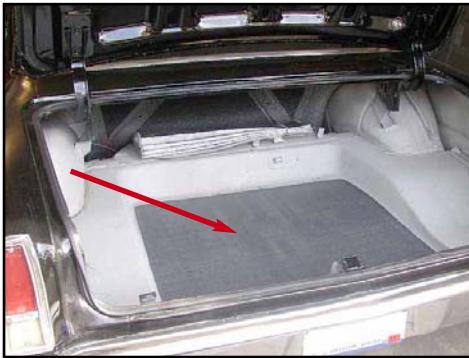

### ORIGINAL STYLE

Die-cut to fit your trunk exactly. Made of the same molded vinyl and design as the original.

Improves the appearance of your trunk space dramatically.

- |          |       |                              |              |
|----------|-------|------------------------------|--------------|
| 62-09016 | 62-66 | Black & Gray,<br>Crowsteet   | \$ 43.00 ea. |
| 62-09017 | 62-66 | Black & Aqua,<br>Herringbone | \$ 43.00 ea. |
| 67-09016 | 67    | Black & Aqua<br>Houndstooth  | \$ 43.00 ea. |



- |          |       |                              |              |
|----------|-------|------------------------------|--------------|
| 68-09016 | 68-72 | Black & Aqua,<br>Herringbone | \$ 43.00 ea. |
|----------|-------|------------------------------|--------------|

## TRUNK SPATTER PAINT



Spruce up your trunk space with some fresh spatter paint. Available in the original colors. We suggest 3 cans for complete coverage.

- |           |              |              |
|-----------|--------------|--------------|
| 67-09024  | Black & Aqua | \$ 14.00 ea. |
| 67-09025  | Gray & White | \$ 14.00 ea. |
| 67-184022 | Top coat     | \$ 14.00 ea. |

## SPARE TIRE COVER

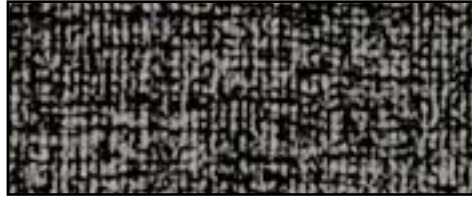

Matches our original style trunk mat. Features a stiff cardboard backing in the center for an excellent fit.

- |           |       |                                 |              |
|-----------|-------|---------------------------------|--------------|
| 64-06914+ | 62-66 | 14", Black & Gray,<br>Crowsteet | \$ 43.00 ea. |
| 64-06915+ | 62-66 | 15", Black & Gray,<br>Crowsteet | \$ 43.00 ea. |



- |           |    |                                   |              |
|-----------|----|-----------------------------------|--------------|
| 67-09101+ | 67 | 14", Black & Aqua,<br>Houndstooth | \$ 43.00 ea. |
| 67-09103+ | 67 | 15", Black & Aqua,<br>Houndstooth | \$ 43.00 ea. |



- |           |       |                                   |              |
|-----------|-------|-----------------------------------|--------------|
| 64-06920+ | 68-72 | 15", Black & Aqua,<br>Herringbone | \$ 43.00 ea. |
|-----------|-------|-----------------------------------|--------------|

## RADIO SUPPORT BRACKETS



- |          |       |              |
|----------|-------|--------------|
| 69-09171 | 69-74 | \$ 10.00 ea. |
|----------|-------|--------------|

## RADIO DELETE PLATE



Injection molded like original, chrome hot stamped on the edge. 100% correct concours show quality.

- |          |       |              |
|----------|-------|--------------|
| 69-09175 | 69-74 | \$ 69.00 ea. |
|----------|-------|--------------|

## RADIO CAPACITORS



Mounts to coil bracket, connects to positive post on coil.

- |          |       |              |
|----------|-------|--------------|
| 67-09165 | 62-72 | \$ 21.00 ea. |
|----------|-------|--------------|

Mounts to voltage regulator, connects to ground tab on regulator.

- |          |                     |              |
|----------|---------------------|--------------|
| 67-09166 | 64-71 <sup>E</sup>  | \$ 21.00 ea. |
| 71-09167 | 71 <sup>L</sup> -72 | \$ 21.00 ea. |

## AM / FM RADIO LENSES

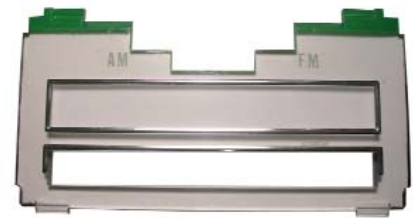

- |          |       |             |              |
|----------|-------|-------------|--------------|
| 69-09207 | 69-70 | with mono   | \$ 27.00 ea. |
| 69-09208 | 69-70 | with stereo | \$ 27.00 ea. |
| 71-09210 | 71-72 | with mono   | \$ 28.00 ea. |
| 71-09211 | 71-72 | with stereo | \$ 28.00 ea. |

## "iCAMKIT" I-POD CONNECTOR



Fits Custom Autosound model 5, 6, 630 and secretaudio stereos.

Once connected, you can charge your i-pod, access playlist and select songs all from the controls on the radio.

- |          |       |               |
|----------|-------|---------------|
| 67-09160 | 66-72 | \$ 109.00 ea. |
|----------|-------|---------------|

## "BLUEKIT" BLUETOOTH INTERFACE CONNECTOR



Fits Custom Autosound model 630 and secretaudio stereos.

This adapter plugs into the CD changer port of your Custom Autosound radio and gives you the ability to do hands free calling from your bluetooth capable phone.

Also listen to music stored on your A2DP enabled bluetooth device. If you have a CD changer you can still use it with the adapter plugged in, (there is a CD changer port on the control box of the Bluekit).

Main control box has a 1.5' cord that goes to radio CD port, 6.5' cord to answer button and 3.5' cord from answer button to microphone.

- |          |         |               |
|----------|---------|---------------|
| 62-09161 | Bluekit | \$ 109.00 ea. |
|----------|---------|---------------|

+ The following items require additional shipping and handling.



# CHEVROLET NOVA PARTS



Car Shop Inc. 739 North Batavia Orange, California 92868

## STEREOS



Custom Autosound **Model 1** AM/FM Cassette

- 200 watts increased power rating • AM/FM auto-reverse cassette • auxiliary input for i-pod, MP3, DVD or satellite • digital clock • upgraded AM/FM tuner for optimum reception • scan & seek • 4-channel RCA pre-out • separate bass & treble controls • 18 FM & 12 AM presets • 2-year manufacturers warranty.

|          |       |       |               |
|----------|-------|-------|---------------|
| 66-09110 | 66-67 | ..... | \$ 199.00 ea. |
| 68-09111 | 68-72 | ..... | \$ 199.00 ea. |

## STEREO & CD COMBO



Custom Autosound **Model 630**

No Cassette player. looks like AM radio when off  
Digital display lights up through AM lens

- 240 watts • AM/FM no cassette • Alpha numeric display for built-in USB MP3/WMA player • Built in CD changer controller • optional 6 disc CD changer • auxiliary input for i-pod, MP3, DVD or satellite • digital clock • upgraded AM/FM tuners for optimum reception • scan & seek • 4-channel RCA pre-out • separate bass & treble • 18 FM & 12 AM presets • 2-year manufacturers warranty.

|          |       |                                |               |
|----------|-------|--------------------------------|---------------|
| 66-09201 | 66-67 | Model 630 radio only ...       | \$ 239.00 ea. |
| 66-09202 | 66-67 | Model 630 and CD changer ..... | \$ 479.00 kit |
| 68-09203 | 68-72 | Model 630 radio only ...       | \$ 239.00 ea. |
| 68-09204 | 68-72 | Model 630 and CD changer ..... | \$ 479.00 kit |

## SECRET AUDIO RADIO



Custom Autosound **SECRETAUDIO SS**

Hideaway Audio Solution

- 200 watts increased power rating • AM/FM • Built in CD changer controller • optional 6 disc CD changer • digital clock • upgraded AM/FM tuners for optimum reception • dual RCA pre-outs, front & rear • separate bass & treble • 18 FM & 12 AM presets • 2-year manufacturers warranty. • "RF" radio frequency wireless remote, up to 40 feet • 2 mounting options, flush mount or under dash swivel mount •

|          |       |                       |               |
|----------|-------|-----------------------|---------------|
| 64-06950 | 62-79 | radio .....           | \$ 285.00 ea. |
| 64-06951 | 62-79 | with CD Changer ..... | \$ 525.00 kit |

## RETRO SOUND STEREO MODEL 2

Retro Sound **Model Two Stereo**

Built-in Bluetooth for hands free calling.

iPod & iPhone control via USB.

Connect, play and charge your iPod or iPhone directly from the radio with no additional adapters.

Plays MP3 & WMA files via USB input, Selectable 32,000 color LCD illumination with user presets, AM/FM tuner with 30 presets and RDS, USA/EU/Japan tuner frequencies, USB input & subwoofer output, authentic push-button styling, 2 sets of RCA low level outputs.

Built-in amplifier (25 watts RMS/45 watts peak x 4 channels)

2 Year parts and labor Warranty.

### Black face radio

|           |       |       |               |
|-----------|-------|-------|---------------|
| 62-091344 | 62-65 | ..... | \$ 359.00 ea. |
| 66-091344 | 66-67 | ..... | \$ 359.00 ea. |
| 69-091344 | 69-76 | ..... | \$ 359.00 ea. |

### Chrome face radio

|           |       |       |               |
|-----------|-------|-------|---------------|
| 62-091347 | 62-65 | ..... | \$ 359.00 ea. |
| 65-091347 | 66-67 | ..... | \$ 359.00 ea. |
| 69-091347 | 69-76 | ..... | \$ 359.00 ea. |

## RETRO SOUND ZUMA STEREO



Retro Sound **ZUMA Stereo**

Retro Sound's new Zuma digital media receiver will mount in most classic vehicles using an ingenious InfiniMount bracket and shaft system that adjusts to fit any dash opening. The new Retro Sound Zuma looks like an old-fashioned radio, complete with authentic-look push button styling and replica knobs, but offers the modern conveniences of a rear mounted USB port, two auxiliary inputs, built in high power amplifier and digital AM/FM tuner with RDS. You can connect your digital audio player, satellite radio, or a USB thumb drive loaded with music files and enjoy hours of entertainment in your classic vehicle.

An enhanced LCD display features dual-color (white and green) illumination. Two sets of preamp outputs let you add external amplifiers. For the latest and greatest in audio technology for your car, choose a Retro Sound Zuma.

Am/Fm tuner with 30 presets and RDS, Authentic pushbutton styling, Built-in amplifier (25 watts RMS/45 watts peak x 4 channels), 3 EQ presets plus user-controlled bass/treble/fader/balance adjustment.

1 Year parts and labor Warranty.

### Black face radio

|           |       |       |               |
|-----------|-------|-------|---------------|
| 62-091354 | 62-65 | ..... | \$ 259.00 ea. |
| 66-091354 | 66-67 | ..... | \$ 259.00 ea. |
| 69-091354 | 69-76 | ..... | \$ 259.00 ea. |



### Chrome face radio

|           |       |       |               |
|-----------|-------|-------|---------------|
| 62-091357 | 62-65 | ..... | \$ 259.00 ea. |
| 66-091357 | 66-67 | ..... | \$ 259.00 ea. |
| 69-091357 | 69-76 | ..... | \$ 259.00 ea. |

• Car Shop •  
• Best Quality • Best Price •

## Retro Sound ZUMA



Retro Sound **Model 2**



† The following items require additional shipping and handling.

Fax Order 1-714-771-0407 • Toll Free 1-800-235-2470 • www.TruckandCarShop.com • 2014 Catalog



# CHEVROLET NOVA PARTS

Car Shop Inc. 739 North Batavia Orange, California 92868

## REPRODUCTION RADIOS



### Nova AM/FM/Stereo Radios

- Small size, BIG features, Rare option!
- Looks original! but offers today's technology!
- Quality Chrome plated faceplate and knobs exactly match original radio!
- Fits your dash without any modifications!
- 4 x 45 watts RMS output allows up to 180 watts of audio power!
- Green AM/FM dial scale looks like original!
- AM or FM band selected with slide-bar like original!
- Analog controls look and feel like the original radio!
- All controls easily accessible. Volume, bass, treble, balance, fader and tuning from original looking controls!
- MP3, IPOD, CD or XM (satellite) inputs included!
- 7/16" shafts for mounting exactly match original radio!
- LED dial lights will never need replacing!
- Digitally tuned AM/FM/Stereo front end provides stable, high quality reception!



"Blue Dot" Stereo Indicator! Dial face lights green!

69-09156 69 ..... \$ 595.00 ea.



"Amber" stereo indicator! Dial face lights green!

70-09157 70 ..... \$ 595.00 ea.



"Amber" stereo indicator! Dial face lights blue!

71-09157 71-76 ..... \$ 595.00 ea.

## RADIO RETAINING NUTS



67-09212 62-79 ..... \$ 5.00 pr.

## RADIO KNOBS



61-06014 62-63 Volume/Tuning ..... \$ 11.00 ea.  
64-06015 64 Volume/Tuning ..... \$ 7.00 ea.



64-07102 65-66 Volume/Tuning ..... \$ 14.00 pr.



64-07103 64-65 Tone/Fader ..... \$ 21.00 pr.



66-07103 66 Tone/Fader ..... \$ 14.00 pr.



67-09213 67 Volume/Tuning, chrome . \$ 13.00 pr.



Plastic design, black.

67-09214 67 Tone/Fader, black . . . \$ 8.00 pr.



Chrome metal design.

67-071031 67 Tone/Fader ..... \$ 14.00 pr.



68-07104 68 Volume/Tuning  
Tone/Fader ..... \$ 51.00 set



69-09215 69-70 Volume/Tuning ..... \$ 16.00 pr.

## RADIO KNOBS



69-09216 69-70 Tone/Fader, mono . . . . \$ 11.00 pr.  
69-09217 69-70 Tone/Fader, stereo . . . . \$ 11.00 pr.



72-09215 71-76 Volume/Tuning ..... \$ 19.00 pr.



72-09216 71-76 without tab ..... \$ 8.00 ea.  
72-09217 71-76 with tab ..... \$ 8.00 ea.

## RADIO COLOR BAR



### DRIVER QUALITY

58-06018 Bowman style color bar . . . . \$ 139.00 ea.



### SHOW QUALITY

Includes: mounting hardware, replacement lens and instructions.

58-060181 Show Quality, Black . . . . . \$ 215.00 ea.

58-060182 Show Quality, Chrome . . . . . \$ 279.00 ea.

# CHEVROLET NOVA PARTS



Car Shop Inc. 739 North Batavia Orange, California 92868

## DUAL FRONT SPEAKER SET



Our dual front speaker fits where the original mono speaker mounts under the dash. This gives you the great sound of two speakers in the front of your car without having to cut your door panels.

- 61-06007 62-65 With A/C .....\$ 29.00 set
- 66-07108 66-67 With A/C .....\$ 36.00 set
- 66-07107 66-67 Without A/C .....\$ 36.00 set
- 67-09218 68-76 With A/C .....\$ 36.00 set
- 67-09219 68-76 Without A/C .....\$ 36.00 set

## DUAL VOICE COIL DASH SPEAKERS



These speakers have up to 70% more cone area than the conventional dual speaker setup. This will give you improved bass response and power handling (140 watts). Both stereo channels hook directly to one speaker. This is the best sound solution for the original dash location we have found.

- 67-060112 66-67 With A/C .....\$ 56.00 ea.
- 66-071072 66-67 Without A/C .....\$ 56.00 ea.
- 67-092192 68-76 Without A/C .....\$ 56.00 ea.

## 4 X 6 KICK PANEL SPEAKERS



- 67-09221 "Custom auto sound" ...\$ 49.00 pr.

## 4 X 6 KICK PANEL SPEAKER GRILLS



- 67-09223 .....\$ 40.00 pr.

## 6 X 9 REAR SPEAKER GRILL



- 67-09301 67-74 .....\$ 23.00 ea.

## 6 X 9 REAR SPEAKERS



- 67-09302 Custom auto sound  
3-way coaxial, 200 watts \$ 78.00 pr.
- 67-09304 Kenwood  
200 watts .....\$ 89.00 pr.

## RETRO SOUND UNIVERSAL SPEAKERS



- Dual voice coil 5 x 7 speaker. 1.77" mount depth. 60 watts RMS.
- 67-09230 5 x 7 .....\$ 46.00 ea.



- Dual voice coil 6 x 9 speaker. 1.77" mount depth. 100 watts RMS.
- 67-09231 6 x 9 .....\$ 65.00 ea.



- Single voice coil 4.5" round speakers. 1.30" mount depth. 40 watts.
- 67-09232 4.5" round .....\$ 65.00 pr.
- Single voice coil 5.25" round speakers. 1.77" mount depth. 40 watts.
- 67-09233 5.25" round .....\$ 75.00 pr.

## RETRO SOUND UNIVERSAL SPEAKERS



Single voice coil 6.5" round universal mount speakers. 1.77" mount depth. 50 watts RMS.

- 67-09234 6.5" round .....\$ 79.00 pr.

## UNIVERSAL SPEAKERS



Universal, 200 watts, 5" neodymium woofer with 1 tweeter 11" x 8.5" x 3".

- 67-09307 .....\$ 115.00 pr.



Universal, 250 watts, 8" neodymium woofer with 2 tweeters 12.5" x 11" x 3".

- 67-093071 .....\$ 135.00 pr.

## POWERED 8" SUBWOOFER



Universal 100-watt-powered 8" subwoofer, black aluminum enclosure, high/low inputs, adjustable crossover network (50-100Hz), adjustable 0-180 degree phase control, Frequency response range: 35-100Hz. Enclosure size: 9" x 2.75" x 13.75"

- 67-093072 .....\$ 179.00 ea.

+ The following items require additional shipping and handling.

Fax Order 1-714-771-0407 • Toll Free 1-800-235-2470 • [www.TruckandCarShop.com](http://www.TruckandCarShop.com) • 2014 Catalog



# CHEVROLET NOVA PARTS

Car Shop Inc. 739 North Batavia Orange, California 92868

## ANTENNA GASKET



**Fargo**  
67-09308 62-72 .....\$ 2.00 ea.

## ANTENNA GROUND PLATE



67-09309 68-72 .....\$ 6.00 ea.

## ANTENNA BEZEL



69-09311 68-72 .....\$ 11.00 ea.

## ANTENNA BEZEL NUT



**Fargo**  
67-09312 68 .....\$ 6.00 ea.



69-09313 69-72 .....\$ 7.00 ea.

## FRONT ANTENNA CABLE & BODY



67-09314 68-72 .....\$ 16.00 ea.



70-09314 73-79 .....\$ 20.00 ea.

## ANTENNA MAST



*Round, telescopic screw-in style.*  
64-03008 62-66 screw-in style .....\$ 12.00 ea.



*Oval, telescopic antenna masts, stainless steel.*  
67-093166 62-66 screw-in style .....\$ 60.00 ea.  
67-093167 67-72 plug style with nut .....\$ 60.00 ea.



*Fixed mast AM/FM style antenna mast, plug style with nut.*  
67-093162 68-72 mast only .....\$ 10.00 ea.



## FRONT ANTENNAS



63-03023 62-65 Telescopic, includes cable . \$ 44.00 ea.

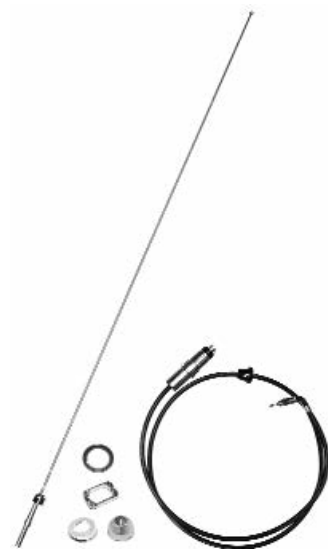

**Fixed mast AM/FM style antennas**  
*Includes: antenna mast, body, cable, chrome bezel, chrome nut, gasket and ground plate.*

67-09315 68 .....\$ 38.00 kit  
69-09316 69-72 .....\$ 38.00 kit



**Telescopic mast AM style antennas**  
*Features original oval shaped telescopic mast!*  
*Includes: antenna mast, body, cable, chrome bezel, chrome nut, gasket and ground ring.*

67-093151 68 .....\$ 179.00 kit  
69-093161 69-70 .....\$ 179.00 kit

# CHEVROLET NOVA PARTS



Car Shop Inc. 739 North Batavia Orange, California 92868

## REAR ANTENNAS



Features round telescopic screw-in style antenna mast.

- 64-03019 62-64 RH, includes cable . . . \$ 48.00 ea.
- 64-03020 62-64 LH, "dummy" . . . . . \$ 42.00 ea.



Features round telescopic screw-in style antenna mast.

- 65-03021 65-67 RH, includes cable . . . \$ 58.00 ea.
- 65-03022 65-67 LH, "dummy" . . . . . \$ 52.00 ea.

## ANTI-DIESEL SOLENOID WIRE



Commonly known as the idle stop solenoid, this wire provides power to the solenoid.

- 70-09410 70 all V8 except B/B with M/T . . . . . \$ 10.50 ea.

## AIR CONDITIONING HARNESS

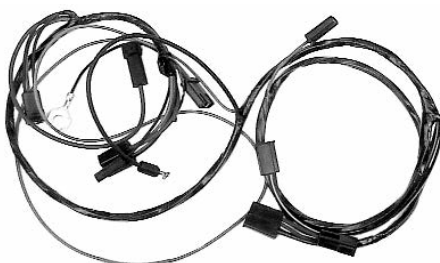

This harness provides wiring for the air conditioning system from under the dash to the engine compartment, includes heater wiring.

- 62-09401 62 4 & 6 cyl. . . . . \$ 112.00 ea.
- 62-09402 62 V8 . . . . . \$ 112.00 ea.
- 63-09401 63 4 & 6 cyl. . . . . \$ 109.00 ea.
- 63-09402 63 V8 . . . . . \$ 109.00 ea.
- 64 . . . . . \$ 109.00 ea.
- 65-09401 65 . . . . . \$ 109.00 ea.
- 66-09401 66-67 . . . . . \$ 109.00 ea.
- 68-09401 68 . . . . . \$ 119.00 ea.
- 69-09401 69-70 . . . . . \$ 108.00 ea.
- 71-09401 71 . . . . . \$ 119.00 ea.
- 72-09401 72 . . . . . \$ 119.00 ea.
- 73-09401 73-74 . . . . . \$ 119.00 ea.

### Air Conditioning Extension Harness

Compressor to A/C harness.

- 73-094075 73-74 . . . . . \$ 27.00 ea.

### Air Conditioning Compressor Ground Wire

- 62-094077 62-65 . . . . . \$ 8.00 ea.

### Air Conditioning Power Feed Wire

Starter solenoid to A/C harness.

- 62-09408 62-63 4 & 6 cyl . . . . . \$ 16.00 ea.
- 62-09409 62-63 V8 . . . . . \$ 16.00 ea.
- 64-09408 64 6 cyl . . . . . \$ 16.00 ea.
- 64-09409 64 V8 . . . . . \$ 16.00 ea.

Supplies power to the A/C compressor, Horn relay to A/C inline fuse.

- 65-09408 65-66 . . . . . \$ 16.00 ea.
- 67-09409 67 . . . . . \$ 16.00 ea.
- 67-09408 68-71 . . . . . \$ 16.00 ea.
- 72-09408 72 . . . . . \$ 17.00 ea.

## ALTERNATOR CONVERSION KIT



Converts your existing harness to use an internally regulated alternator.

- 67-15404 63-73 External to internal regulator harness . . . . . \$ 18.00 kit

## CLOCK HARNESS



- 64-09411 64 Dash mounted . . . . . \$ 15.00 ea.
- 68-09411 68-72 Dash mounted . . . . . \$ 14.00 ea.

## CONSOLE HARNESS



Wiring for console lights, shift lens neutral safety switch and console gauges when applicable.

- 63-09415 63-64 with A/T . . . . . \$ 32.00 ea.
- 63-09416 63-64 with courtesy lamps . . . \$ 20.00 ea.
- 65-09415 65-66 with A/T . . . . . \$ 32.00 ea.
- 67-09415 67 with A/T . . . . . \$ 32.00 ea.

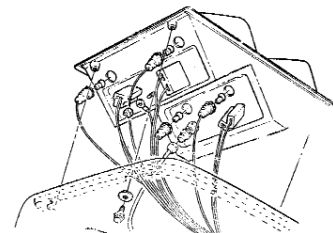

- 68-09415 68-72 with console gauges . . \$ 44.00 ea.
- 73-09415 73-75 with console gauges . . \$ 44.00 ea.

## DASH EXTENSION HARNESS



Glove box & heater panel lamp extension harness.

- 68-09510 68 . . . . . \$ 23.00 ea.

\* The following items require additional shipping and handling.



# CHEVROLET NOVA PARTS

Car Shop Inc. 739 North Batavia Orange, California 92868

## DASH / INSTRUMENT PANEL HARNESS



This brand new reproduction dash harness features a new fuse box, connectors, wires, terminals and tape. Complete and ready to be installed, all are circuit tested to insure quality.

|           |       |   |               |
|-----------|-------|---|---------------|
| 62-09432  | 62    | with A/T                                | \$ 357.00 ea. |
| 62-09433  | 62    | with M/T                                | \$ 370.00 ea. |
| 63-09432  | 63-64 | with warning lights                     | \$ 357.00 ea. |
| 63-09433  | 63-64 | with gauges                             | \$ 357.00 ea. |
| 65-09434  | 65    | with warning lights                     | \$ 357.00 ea. |
| 65-09435  | 65    | with gauges                             | \$ 357.00 ea. |
| 66-09435  | 66    | all                                     | \$ 357.00 ea. |
| 67-09435  | 67    | all                                     | \$ 357.00 ea. |
| 68-09433  | 68    | A/T, column shift                       | \$ 432.00 ea. |
| 68-09434  | 68    | M/T, all w/o gauges                     | \$ 432.00 ea. |
| 68-09435  | 68    | A/T, console shift                      | \$ 432.00 ea. |
| 68-09436  | 68    | M/T, console shift with gauges          | \$ 432.00 ea. |
| 68-09437  | 68    | A/T, console shift with gauges          | \$ 432.00 ea. |
| 69-09438  | 69    | A/T, column shift w/o AC                |               |
|           | 69    | M/T, all w/o AC                         | \$ 432.00 ea. |
| 69-094381 | 69    | A/T, column shift with AC               |               |
|           | 69    | M/T, all with AC                        | \$ 432.00 ea. |
| 69-09439  | 69    | A/T, console shift                      | \$ 432.00 ea. |
| 69-09440  | 69    | A/T, console shift with gauges          | \$ 432.00 ea. |
| 69-09441  | 69    | M/T, console shift with gauges          | \$ 432.00 ea. |
| 70-09442  | 70    | A/T, column shift                       |               |
|           | 70    | M/T, floor shift                        | \$ 436.00 ea. |
| 70-09443  | 70    | A/T, console shift                      | \$ 436.00 ea. |
| 70-09444  | 70    | A/T, console shift with gauges          | \$ 436.00 ea. |
| 70-09445  | 70    | M/T, console shift with gauges          | \$ 436.00 ea. |
| 71-09446  | 71    | A/T, column shift                       |               |
|           | 71    | M/T, all w/o gauges                     | \$ 436.00 ea. |
| 71-09447  | 71    | A/T, console shift                      | \$ 436.00 ea. |
| 71-09448  | 71    | A/T, console shift with gauges          | \$ 436.00 ea. |
| 71-09449  | 71    | M/T, console shift with gauges          | \$ 436.00 ea. |
| 72-09450  | 72    | with warning lights                     | \$ 454.00 ea. |
| 72-09451  | 72    | with warning lights & seat belt warning | \$ 495.00 ea. |
| 72-09452  | 72    | with gauges                             | \$ 454.00 ea. |
| 72-09453  | 72    | with gauges & seat belt warning         | \$ 454.00 ea. |
| 73-09454  | 73    | with warning lights                     | \$ 489.00 ea. |
| 73-09455  | 73    | with gauges                             | \$ 489.00 ea. |
| 74-09456  | 74    | with warning lights                     | \$ 489.00 ea. |
| 74-09457  | 74    | with gauges                             | \$ 489.00 ea. |

## ENGINE HARNESS

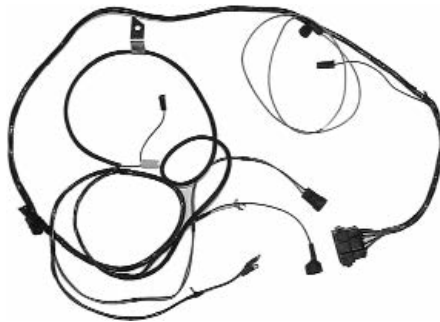

Stock replacement harness. This harness contains wiring for the starter, wiper motor, heater blower motor, coil etc...

|           |       |  |               |
|-----------|-------|--|---------------|
| 62-09517  | 62-66 | 4 cylinder                               | \$ 86.00 ea.  |
| 62-09518  | 62-66 | 6 cylinder                               | \$ 86.00 ea.  |
| 63-09519  | 63-65 | 6 cyl. with gauges                       | \$ 85.00 ea.  |
| 62-09520  | 62-66 | V8                                       | \$ 85.00 ea.  |
| 63-09522  | 63-65 | V8 with gauges                           | \$ 85.00 ea.  |
| 67-09524  | 67    | 4 cylinder                               | \$ 88.00 ea.  |
| 67-09525  | 67    | 6 cylinder                               | \$ 86.00 ea.  |
| 67-09526  | 67    | V8                                       | \$ 86.00 ea.  |
| 68-09522  | 68-69 | 6 cylinder                               | \$ 87.00 ea.  |
| 68-09524  | 68    | S/B, w/o gauges                          | \$ 87.00 ea.  |
| 68-09525  | 68    | B/B, w/o gauges                          | \$ 87.00 ea.  |
| 68-09526  | 68    | V8, with gauges                          | \$ 87.00 ea.  |
| 68-095261 | 68    | V8, with gauges                          | \$ 111.00 ea. |
| 69-09528  | 69    | 6 cylinder with idle stop solenoid       | \$ 87.00 ea.  |
| 69-09529  | 69    | S/B, w/o gauges                          | \$ 87.00 ea.  |
| 69-09530  | 69    | S/B, with idle stop solenoid             | \$ 87.00 ea.  |
| 69-09540  | 69    | B/B, w/o gauges                          | \$ 94.00 ea.  |
| 69-09532  | 69    | B/B, with idle stop solenoid, w/o gauges | \$ 87.00 ea.  |
| 69-09533  | 69    | V8 with gauges                           | \$ 87.00 ea.  |
| 69-09534  | 69    | V8 with gauges with idle stop solenoid   | \$ 87.00 ea.  |
| 70-09542  | 70    | 6 cylinder, A/T                          | \$ 148.00 ea. |
| 70-09543  | 70    | 6 cylinder, M/T                          | \$ 148.00 ea. |
| 70-09544  | 70    | S/B, A/T, w/o gauges                     | \$ 146.00 ea. |
| 70-09545  | 70    | S/B, A/T, with gauges                    | \$ 148.00 ea. |
| 70-09546  | 70    | S/B, M/T, w/o gauges                     | \$ 148.00 ea. |
| 70-09547  | 70    | S/B, M/T, with gauges                    | \$ 148.00 ea. |
| 70-09548  | 70    | B/B, A/T, w/o gauges                     | \$ 148.00 ea. |
| 70-09549  | 70    | B/B, A/T, with gauges                    | \$ 152.00 ea. |
| 70-09550  | 70    | B/B, M/T, w/o gauges                     | \$ 146.00 ea. |
| 70-09551  | 70    | B/B, M/T, with gauges                    | \$ 146.00 ea. |
| 71-09542  | 71    | 6 cylinder, A/T                          | \$ 148.00 ea. |
| 71-09543  | 71    | 6 cylinder, M/T                          | \$ 152.00 ea. |
| 71-09544  | 71    | V8, A/T, w/o gauges                      | \$ 146.00 ea. |
| 71-09545  | 71    | V8, A/T, with gauges                     | \$ 146.00 ea. |
| 71-09546  | 71    | V8, M/T, w/o gauges                      | \$ 146.00 ea. |
| 71-09547  | 71    | V8, M/T, with gauges                     | \$ 146.00 ea. |
| 72-09542  | 72    | 6 cylinder                               | \$ 166.00 ea. |
| 72-09544  | 72    | V8                                       | \$ 159.00 ea. |
| 72-09545  | 72    | V8, with gauges                          | \$ 160.00 ea. |

## ENGINE HARNESS



Stock replacement harness.

|          |    |                      |               |
|----------|----|----------------------|---------------|
| 73-09542 | 73 | 6 cylinder           | \$ 174.00 ea. |
| 73-09544 | 73 | V8                   | \$ 169.00 ea. |
| 73-09561 | 73 | V8, with gauges      | \$ 169.00 ea. |
| 74-09543 | 74 | 6 cylinder           | \$ 174.00 ea. |
| 74-09544 | 74 | V8, A/T, w/o gauges  | \$ 169.00 ea. |
| 74-09545 | 74 | V8, A/T, with gauges | \$ 169.00 ea. |
| 74-09546 | 74 | V8, M/T, w/o gauges  | \$ 169.00 ea. |
| 74-09547 | 74 | V8, M/T, with gauges | \$ 169.00 ea. |

## H.E.I. ENGINE HARNESS

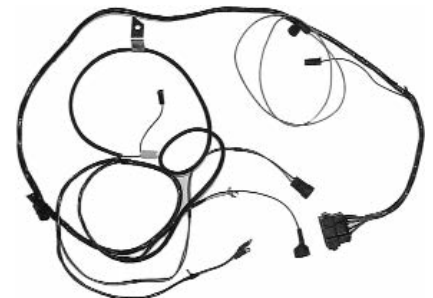

Modified for use with HEI distributors.

|           |       |                                   |               |
|-----------|-------|-----------------------------------|---------------|
| 62-09521  | 62-66 | V8 with H.E.I.                    | \$ 102.00 ea. |
| 63-09523  | 63-65 | V8, with H.E.I. with gauges       | \$ 102.00 ea. |
| 67-09527  | 67    | V8, with H.E.I.                   | \$ 102.00 ea. |
| 68-095241 | 68    | S/B, with H.E.I. w/o gauges       | \$ 111.00 ea. |
| 68-095251 | 68    | B/B, with H.E.I. w/o gauges       | \$ 111.00 ea. |
| 69-095291 | 69    | S/B, w/o gauges with H.E.I.       | \$ 111.00 ea. |
| 69-095401 | 69    | B/B, w/o gauges with H.E.I.       | \$ 111.00 ea. |
| 69-095331 | 69    | V8 with gauges with H.E.I.        | \$ 111.00 ea. |
| 70-095441 | 70    | S/B, A/T, w/o gauges with H.E.I.  | \$ 159.00 ea. |
| 70-095451 | 70    | S/B, A/T, with gauges with H.E.I. | \$ 159.00 ea. |
| 70-095461 | 70    | S/B, M/T, w/o gauges with H.E.I.  | \$ 159.00 ea. |
| 70-095471 | 70    | S/B, M/T, with gauges with H.E.I. | \$ 165.00 ea. |
| 70-095481 | 70    | B/B, A/T, w/o gauges with H.E.I.  | \$ 170.00 ea. |
| 70-095491 | 70    | B/B, A/T, with gauges with H.E.I. | \$ 170.00 ea. |
| 70-095501 | 70    | B/B, M/T, w/o gauges with H.E.I.  | \$ 165.00 ea. |
| 70-095511 | 70    | B/B, M/T, with gauges with H.E.I. | \$ 165.00 ea. |
| 71-095451 | 71    | V8, A/T, with gauges with H.E.I.  | \$ 159.00 ea. |
| 71-095471 | 71    | V8, M/T, with gauges              | \$ 159.00 ea. |

\* The following items require additional shipping and handling.

# CHEVROLET NOVA PARTS



Car Shop Inc. 739 North Batavia Orange, California 92868

## FORWARD LAMP HARNESS



This harness routes from the firewall forward and across the radiator core support. Contains wiring for the alternator, headlights, parking lights, horn relay etc...Stock replacements

|          |    |                        |               |
|----------|----|------------------------|---------------|
| 62-09563 | 62 | with generator         | \$ 152.00 ea. |
| 63-09563 | 63 | all                    | \$ 150.00 ea. |
| 64-09563 | 64 | all                    | \$ 150.00 ea. |
| 65-09563 | 65 | all                    | \$ 150.00 ea. |
| 66-09563 | 66 | all                    | \$ 150.00 ea. |
| 67-09563 | 67 | all                    | \$ 150.00 ea. |
| 68-09563 | 68 | 6 cylinder             | \$ 167.00 ea. |
| 68-09564 | 68 | V8, w/o gauges         | \$ 160.00 ea. |
| 68-09565 | 68 | V8, with gauges        | \$ 167.00 ea. |
| 69-09563 | 69 | 6 cylinder             | \$ 160.00 ea. |
| 69-09564 | 69 | V8, w/o gauges         | \$ 160.00 ea. |
| 69-09565 | 69 | V8, with gauges        | \$ 160.00 ea. |
| 70-09563 | 70 | 6 cylinder             | \$ 163.00 ea. |
| 70-09564 | 70 | V8, w/o gauges         | \$ 163.00 ea. |
| 70-09565 | 70 | V8, with gauges        | \$ 163.00 ea. |
| 70-09566 | 70 | V8, w/o gauges with AC | \$ 163.00 ea. |
| 71-09563 | 71 | 6 cylinder             | \$ 169.00 ea. |
| 71-09564 | 71 | V8, w/o gauges         | \$ 163.00 ea. |
| 71-09565 | 71 | V8, with gauges        | \$ 163.00 ea. |
| 72-09566 | 72 | all                    | \$ 163.00 ea. |
| 73-09567 | 73 | all                    | \$ 168.00 ea. |
| 74-09568 | 74 | all                    | \$ 168.00 ea. |

## FORWARD LAMP HARNESS-"INTERNAL REGULATED"

Modified for use with internal regulated alternator.

|           |       |  |               |
|-----------|-------|--|---------------|
| 63-095631 | 63-64 | driver side mount                            | \$ 168.00 ea. |
| 65-095631 | 65    | driver side mount                            | \$ 168.00 ea. |
| 66-095631 | 66    | driver side mount                            | \$ 168.00 ea. |
| 67-095631 | 67    | driver side mount                            | \$ 168.00 ea. |
| 68-095641 | 68    | V8, w/o gauges driver side mount             | \$ 189.00 ea. |
| 68-095651 | 68    | V8, with gauges driver side mount            | \$ 189.00 ea. |
| 68-095661 | 68    | V8, with gauges passenger side mount         | \$ 194.00 ea. |
| 69-095641 | 69    | V8, w/o gauges passenger side mount          | \$ 183.00 ea. |
| 69-095651 | 69    | V8, with gauges passenger side mount         | \$ 189.00 ea. |
| 70-095641 | 70    | V8, w/o gauges passenger side mount          | \$ 185.00 ea. |
| 70-095651 | 70    | V8, with gauges passenger side mount         | \$ 192.00 ea. |
| 70-095661 | 70    | V8, w/o gauges, with AC passenger side mount | \$ 192.00 ea. |
| 71-095641 | 71    | V8, w/o gauges passenger side mount          | \$ 185.00 ea. |
| 71-095651 | 71    | V8, with gauges passenger side mount         | \$ 192.00 ea. |

## HOOD LIGHT KIT



Excellent reproduction of the original factory option hood light RPO U26. Mercury activated switch turns light on when hood is opened.

|          |           |              |
|----------|-----------|--------------|
| 68-09601 | universal | \$ 37.00 kit |
|----------|-----------|--------------|

## TRUNK/ENGINE COMPARTMENT LIGHT KIT



|           |           |              |
|-----------|-----------|--------------|
| 67-096015 | universal | \$ 25.00 ea. |
|-----------|-----------|--------------|

## KICK DOWN HARNESS, TH400



This harness provides wiring for passing gear engagement system on the Turbo 400 auto trans.

|          |       |              |
|----------|-------|--------------|
| 68-09603 | 68-69 | \$ 32.00 ea. |
|----------|-------|--------------|

## NEUTRAL SAFETY EXTENSION



Wiring from the clutch pedal switch to the dash harness.

|          |    |                                       |
|----------|----|---------------------------------------|
| 70-09605 | 70 | With manual trans. . . . \$ 17.00 ea. |
|----------|----|---------------------------------------|

**California Showroom hours:**  
**TUESDAY - FRIDAY: 8:30AM to 4:30PM**  
**SATURDAY: 8:30AM to 3:30PM**  
*(Showroom closed Sunday & Monday)*  
**Phone order desk hours:**  
**MONDAY - FRIDAY: 8:30AM to 4:30PM**  
**ORDER TOLL FREE: 1-800-235-2470**  
**24 HOUR FAX: 714-771-0407**

## REAR LIGHT HARNESSES



### REAR LIGHT HARNESS

|          |       |               |               |
|----------|-------|---------------|---------------|
| 62-09619 | 62    | Coupe         | \$ 134.00 ea. |
| 62-09620 | 62    | Convertible   | \$ 141.00 ea. |
| 63-09619 | 63-64 | Coupe         | \$ 134.00 ea. |
| 63-09620 | 63    | Convertible   | \$ 141.00 ea. |
| 65-09619 | 65    | all exc wagon | \$ 134.00 ea. |
| 66-09619 | 66-67 | all exc wagon | \$ 134.00 ea. |

1968-72 left hand side tail light harness.

|          |       |  |               |
|----------|-------|--|---------------|
| 68-09620 | 68    |  | \$ 151.00 ea. |
| 68-09621 | 68    | with under dash lights                     | \$ 158.00 ea. |
| 69-09620 | 69    |  | \$ 91.00 ea.  |
| 69-09621 | 69    | with under dash lights                     | \$ 103.00 ea. |
| 70-09620 | 70-72 |  | \$ 92.00 ea.  |
| 70-09621 | 70-72 | with under dash lights                     | \$ 104.00 ea. |
| 72-09620 | 72    | with seat belt warning                     | \$ 99.00 ea.  |
| 72-09621 | 72    | with seat belt warning & under dash lights | \$ 109.00 ea. |
| 73-09622 | 73    |  | \$ 88.00 ea.  |
| 74-09622 | 74    |  | \$ 88.00 ea.  |



### REAR LIGHT EXTENSION HARNESS

1962-64 rear light extension harness to back-up lights.

|          |       |     |              |
|----------|-------|-----|--------------|
| 62-09626 | 62-63 | all | \$ 21.00 ea. |
| 64-09626 | 64    | all | \$ 16.00 ea. |

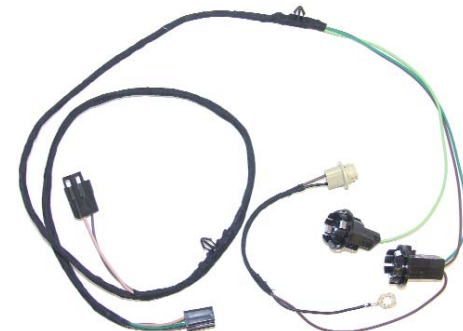

### REAR LIGHT EXTENSION HARNESS

1969-72 right hand side tail light extension harness.

|          |       |  |              |
|----------|-------|--|--------------|
| 69-09626 | 69-71 |  | \$ 74.00 ea. |
| 72-09626 | 72    |  | \$ 74.00 ea. |

\* The following items require additional shipping and handling.

Fax Order 1-714-771-0407 • Toll Free 1-800-235-2470 • [www.TruckandCarShop.com](http://www.TruckandCarShop.com) • 2014 Catalog



# CHEVROLET NOVA PARTS

Car Shop Inc. 739 North Batavia Orange, California 92868

## REAR LIGHT INTERMEDIATE HARNESSSES



Intermediate runs from the dash harness to the rear seat shelf.

|          |    |  |               |
|----------|----|--|---------------|
| 73-09630 | 73 | .....                                    | \$ 92.00 ea.  |
| 73-09631 | 73 | with under dash<br>courtesy lights ..... | \$ 105.00 ea. |

## TAIL LIGHT SOCKET



|          |       |                   |             |
|----------|-------|-------------------|-------------|
| 67-09801 | 62-68 | Brake light ..... | \$ 4.00 ea. |
|----------|-------|-------------------|-------------|



|          |       |                     |              |
|----------|-------|---------------------|--------------|
| 67-09802 | 62-68 | Back up light ..... | \$ 12.00 ea. |
|----------|-------|---------------------|--------------|

## REAR WINDOW DEFROSTER HARNESS



Wiring from the dash mounted switch to the defroster motor.

|          |       |       |              |
|----------|-------|-------|--------------|
| 69-09636 | 69-72 | ..... | \$ 44.00 ea. |
|----------|-------|-------|--------------|

## SPEAKER HARNESS



Wiring for the 4-way speaker system, front & rear.

|          |       |       |              |
|----------|-------|-------|--------------|
| 67-09637 | 68-69 | ..... | \$ 56.00 ea. |
|----------|-------|-------|--------------|

## SPEED WARNING HARNESS



Wiring for the relay and trigger system.

|          |    |       |              |
|----------|----|-------|--------------|
| 67-09638 | 67 | ..... | \$ 18.00 ea. |
| 69-09640 | 69 | ..... | \$ 18.00 ea. |

## TILT STEERING COLUMN WIRE ADAPTERS



Adapts your stock harness to fit ididit columns.

|          |       |       |              |
|----------|-------|-------|--------------|
| 59-13137 | 62    | ..... | \$ 34.00 ea. |
| 63-13138 | 63-65 | ..... | \$ 34.00 ea. |
| 66-13138 | 66    | ..... | \$ 34.00 ea. |
| 67-13138 | 67-68 | ..... | \$ 34.00 ea. |

## TACHOMETER HARNESS

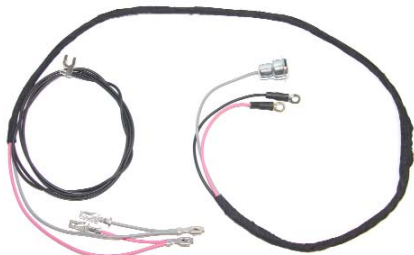

|           |       |                      |              |
|-----------|-------|----------------------|--------------|
| 62-09641  | 62    | .....                | \$ 39.00 ea. |
| 63-09641  | 63    | .....                | \$ 37.00 ea. |
| 64-09641  | 64-65 | Dash mounted .....   | \$ 37.00 ea. |
| 62-116102 | 65-66 | Column mounted ..... | \$ 39.00 ea. |

## TCS SOLENOID



|          |       |                         |               |
|----------|-------|-------------------------|---------------|
| 70-09642 | 70-71 | V8, 2BBL .....          | \$ 84.00 ea.  |
| 70-09643 | 70    | B/B .....               | \$ 109.00 ea. |
| 72-09643 | 72    | S/B .....               | \$ 82.00 ea.  |
| 73-09643 | 73-74 | V8, M/T w/o H.E.I. .... | \$ 82.00 ea.  |

## MUNCIE TCS SWITCH WIRE CLIP



This wire retainer bolts to the side of the transmission cover and guides the TCS harness to the switch on the transmission cover.

|           |       |       |              |
|-----------|-------|-------|--------------|
| 70-096431 | 70-74 | ..... | \$ 20.00 ea. |
|-----------|-------|-------|--------------|

## TCS RELAY



Features GM# 3961573 & LITTELFUSE INC.

|           |       |                  |              |
|-----------|-------|------------------|--------------|
| 70-096425 | 70-76 | 4 terminal ..... | \$ 50.00 ea. |
|-----------|-------|------------------|--------------|

## TRUNK LIGHT KIT



|          |       |       |              |
|----------|-------|-------|--------------|
| 66-07451 | 66-67 | ..... | \$ 28.00 kit |
| 70-07453 | 68-74 | ..... | \$ 28.00 kit |

## TRUNK LIGHT EXTENSION HARNESS

|          |       |       |              |
|----------|-------|-------|--------------|
| 67-09703 | 68-74 | ..... | \$ 10.00 ea. |
|----------|-------|-------|--------------|

## MAIN HARNESS TO FIREWALL SEAL

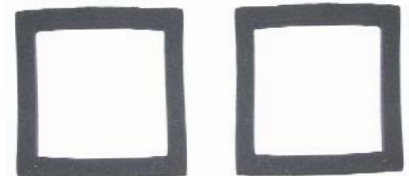

|          |       |       |             |
|----------|-------|-------|-------------|
| 62-09650 | 62-65 | ..... | \$ 4.00 ea. |
|----------|-------|-------|-------------|

## WIPER MOTOR HARNESS



|          |       |                          |              |
|----------|-------|--------------------------|--------------|
| 62-09660 | 62    | 2 speed .....            | \$ 23.00 ea. |
| 63-09661 | 63    | 2 speed, with washer ... | \$ 23.00 ea. |
| 64-09662 | 64    | 2 speed .....            | \$ 23.00 ea. |
| 65-09663 | 65-66 | 2 speed .....            | \$ 23.00 ea. |

## PLASTIC WIRING GUTTER



Features pre-punched holes for easy installation. Mounts on firewall.

|          |       |       |             |
|----------|-------|-------|-------------|
| 67-09705 | 64-72 | ..... | \$ 7.00 ea. |
|----------|-------|-------|-------------|



# CHEVROLET NOVA PARTS



Car Shop Inc. 739 North Batavia Orange, California 92868

## WIRE GUTTER BOLT KIT



67-09701 64-72 .....\$ 2.00 pr.

## COATED METAL "J" STRAPS



67-09706 62-74 2" .....\$ 4.00 ea.

67-09707 62-74 1.5" .....\$ 4.00 ea.

## SINGLE WIRE HARNESS CLIP



67-09709 universal .....\$ 4.00 pr.



62-09707 62-67 Under hood .....\$ 2.50 ea.

## WIRING JUNCTION BLOCK



*This is the plastic junction block that mounts in front of the battery, (auxiliary wire off battery cable runs to it as well as main power wire from Forward Lamp Harness).*

67-09708 67-71 .....\$ 6.00 ea.

## WIRING HARNESS STRAPS



*Plastic straps that hold the harness to the drivers side inner fender.*

67-09709 62-72 .....\$ 1.00 ea.

## FUSE BOX TO FIREWALL BOLTS



*#10 x 2 1/2" black phosphate with wax sealer.*

67-09650 62-74 .....\$ 4.00 pr.

## LIGHT BULBS



*Check owners manual for bulb #'s for your specific year.*

64-07470 # 67, # 97 or #1155 .....\$ 1.50 ea.



64-07471 # 89 .....\$ 2.00 ea.



64-07472 # 90 .....\$ 1.50 ea.



64-07473 # 93 .....\$ 1.50 ea.



64-07474 # 161 .....\$ 1.50 ea.



64-07475 # 168 .....\$ 1.50 ea.



64-07476 # 194 .....\$ 1.50 ea.



64-07477 # 194A, amber .....\$ 1.50 ea.



64-07478 # 211-2 .....\$ 2.00 ea.



64-07479 # 212-2 .....\$ 1.50 ea.



64-07480 # 561 .....\$ 1.50 ea.



64-07481 # 564 .....\$ 1.50 ea.



64-07482 # 631 .....\$ 1.50 ea.

## LIGHT BULBS



64-07483 # 906 .....\$ 1.50 ea.



64-07484 # 1003 .....\$ 1.50 ea.



64-07485 # 1156 .....\$ 1.50 ea.



64-07486 # 1157 .....\$ 1.50 ea.



64-07487 # 1157NA, amber .....\$ 1.50 ea.



64-07488 # 1445 .....\$ 1.50 ea.



64-07489 # 1816 .....\$ 1.50 ea.



64-07490 # 1892 .....\$ 1.50 ea.



64-07491 # 1893 .....\$ 1.50 ea.



64-07492 # 1895 .....\$ 1.50 ea.



64-07493 # 2057NA, amber .....\$ 2.00 ea.

## LIGHT BULBS



*Dash light socket & bulb.*

64-07495 68-74 .....\$ 2.00 ea.

✦ The following items require additional shipping and handling.

Fax Order 1-714-771-0407 • Toll Free 1-800-235-2470 • [www.TruckandCarShop.com](http://www.TruckandCarShop.com) • 2014 Catalog



# CHEVROLET NOVA PARTS

Car Shop Inc. 739 North Batavia Orange, California 92868

## WIRING HARNESS TAPE



This is the Black, vinyl, shiny, **non-adhesive** style harness tape used on all of the harnesses except the rear lamp which used a Black cloth-type tape which is not available at this time. One roll will do 2-3 harnesses.

- 67-09803 1 1/4" wide .....\$ 15.00 roll
- 67-098031 1" wide .....\$ 14.00 roll
- 67-098032 3/4" wide .....\$ 14.00 roll



New cloth wiring harness wrap. Correct for several applications. Sticky backing, super easy to install. Exact textured feel, 100 foot roll.

- 67-098033 .....\$ 18.00 roll

## FIBER OPTIC VIGILITE CHROME BEZEL

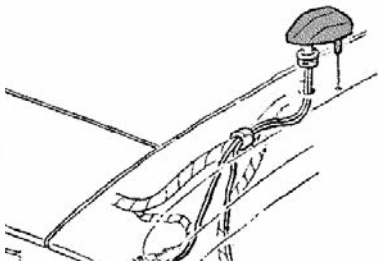

Chrome bezel that fits over fiber optic lens. Mounts on top of fenders.

- 68-09804 68-69 LH or RH .....\$ 29.00 ea.

## SPARK PLUG WIRE SETS



Features original "GM" markings.

- 62-09124 64-67 S/B .....\$ 44.00 set
- 67-09805 68 S/B .....\$ 44.00 set
- 69-09806 69-74 S/B .....\$ 44.00 set
- 67-09807 68-72 B/B .....\$ 44.00 set

## SPARK PLUG WIRE SETS



### "Flame Thrower" 8mm MAGx2 spark plug wire sets

High performance, low resistance, with two current paths for reliability and redundancy.

Features straight plug boots.

- 67-098071 V8, black .....\$ 69.00 set
- 69-098072 V8, blue .....\$ 69.00 set
- 67-098073 V8, red .....\$ 69.00 set

Features 90° plug boots.

- 67-098074 V8, black .....\$ 68.00 set
- 67-098075 V8, blue .....\$ 68.00 set
- 67-098076 V8, red .....\$ 68.00 set

## LOWER PLUG WIRE CLIP



Bolts on with oil pan bolt.

- 58-08737 64-67 .....\$ 5.50 ea.

## SPARK PLUG WIRE RETAINERS



Mounts to spark plug wire heat shield mounting bolt.

- 58-08736 64-67 S/B, LH or RH  
4 per car .....\$ 2.00 ea.



- 58-087361 64-67 S/B, LH or RH,  
lower rear, 2 per car ...\$ 4.00 ea.



- 68-09809 67-74 S/B, RH rear stand ...\$ 11.00 ea.

## SPARK PLUG WIRE RETAINERS



- 67-09810 67 S/B, LH rear stand ...\$ 25.00 ea.
- 68-09811 68 S/B, LH rear stand ...\$ 25.00 ea.



- 69-09812 69 S/B, LH rear stand ...\$ 27.00 ea.
- 70-09813 70-74 S/B, LH rear stand ...\$ 25.00 ea.



- 67-09814 68-72 S/B .....\$ 13.00 set



These are the plastic retainers that mount to the metal tabs on the valve covers.

- 67-09818 68-72 B/B .....\$ 9.00 set



These are the plastic retainers that mount to the metal brackets.

- 67-09819 68-72 2 wire .....\$ 2.50 ea.
- 67-09820 68-72 4 wire .....\$ 2.50 ea.

## CHROME SPARK PLUG WIRE LOOMS

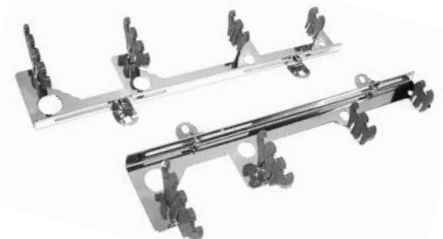

- 67-17507 68-74 S/B or B/B  
Universal .....\$ 24.00 pr.

# CHEVROLET NOVA PARTS



Car Shop Inc. 739 North Batavia Orange, California 92868

## POLISHED ALUMINUM SPARK PLUG WIRE LOOMS SMALL BLOCK OR BIG BLOCK



67-17510 68-74 Ball milled .....\$ 39.00 pr.



67-17511 68-74 With flames .....\$ 40.00 pr.

## SMALL BLOCK SPARK PLUG HEAT SHIELDS



V8 small block spark plug wire heat shields.

58-08802 64-67 4 pcs. ....\$ 17.00 set



Complete set of 4.

67-09821 68-72 S/B .....\$ 28.00 set

## SPARK PLUG HEAT SHIELD BOLTS



Original "L" headmark, 1/4-20 x 1/2" bolt.

67-09901 64-72 S/B heat shield bolt ....\$ 1.50 ea.



8-18 x 1/4, 1/4" hex, .34 O.D. Fastens shield bracket to shield.

67-099011 68-72 .....\$ .50 ea.

## BIG BLOCK SPARK PLUG HEAT SHIELDS



Complete set of 8.

67-09902 68-71 B/B, gold .....\$ 50.00 set

72-09903 72 B/B, silver .....\$ 34.00 set

## SPARK PLUGS



67-09830 63-72 230, 250 #R44XLS ...\$ 2.50 ea.



67-09832 62-68 283, 327 #R45 .....\$ 2.50 ea.

67-09833 62-68 327 #R45S .....\$ 2.50 ea.

67-09834 62-68 327/300HP+ #R43 ...\$ 2.50 ea.



67-09835 62-67 283 #R43S  
69-72 350 #R43S .....\$ 2.50 ea.

69-09836 69-72 307, 350 #R45TS ...\$ 2.50 ea.



67-09837 65-70 396 #R43XLS .....\$ 2.50 ea.

71-09838 71 396, 400 #R44TS ...\$ 2.50 ea.

70-09839 70-71 454 #R43T .....\$ 2.50 ea.

70-09840 70-71 454 #R43TS .....\$ 2.50 ea.

72-09841 72 396, 400, 454 #R44T ...\$ 2.50 ea.

73-09842 73-87 V8 #R45TS .....\$ 2.50 ea.



67-09845 62-68 spark plug gasket ....\$ 1.00 ea.

## ENGINE GROUND STRAP KITS



Reproduction braided copper ground straps. Includes mounting hardware.

62-09904 62-72 .....\$ 15.00 kit

## GROUND WIRE STAR WASHERS



1/4 size, .26 x .69 O.D. internal & external toothed washers.

67-099051 8 pieces .....\$ 3.50 set



5/16 size, .32 x .97 O.D. internal & external toothed washers.

67-099052 4 pieces .....\$ 3.50 set

## HOOD TO COWL GROUND CLIP



Mounts to Firewall Cowl and Grounds Hood to Body of Car.

68-099053 68-74 .....\$ 12.00 ea.



+ The following items require additional shipping and handling.

Fax Order 1-714-771-0407 • Toll Free 1-800-235-2470 • www.TruckandCarShop.com • 2014 Catalog



# CHEVROLET NOVA PARTS

Car Shop Inc. 739 North Batavia Orange, California 92868

## BATTERY TRAYS



Replace your rusted, corroded battery tray with a new one.

62-09906 62-67 .....\$ 19.00 ea.



68-09906 68-74 .....\$ 15.00 ea.

## BATTERY TRAY CLAMP / RETAINER



62-09909 62-67 top retainer .....\$ 14.00 ea.



67-09909 68-74 Clamp .....\$ 3.00 ea.



49-09107 62-67 .....\$ 6.00 pr.



Original "E" headmark, 5/16-18 x 1 1/4" bolt.

67-09910 68-74 Clamp bolt .....\$ 1.00 ea.

## BATTERY TRAY BOLTS



5/16-18 x 5/8, 1/2 hex, with 1.12 conical washer.

67-099105 68-74 .....\$ 3.50 pr.

## BATTERY CABLE CLIPS



Rubber coated spring steel with correct bolt hole size and oil pan clearance bends as original.

67-09933 64-74 On oil pan .....\$ 5.00 ea.

## ELECTRICAL TERMINAL NUTS



10-24, 3/8 hex, with .45 O.D. conical washer.

67-09940 62-79 8 pieces .....\$ 3.50 set

## BATTERY CABLES



Our cables are manufactured with the correct "Spring-Ring" design end, the correct gauge cable and the correct GM part number stamped on each cable when applicable.

### POSITIVE

|          |       |                     |                   |
|----------|-------|---------------------|-------------------|
| 62-09911 | 62-63 | 4 & 6 cylinder      | .....\$ 44.00 ea. |
| 64-09911 | 64-66 | 4 & 6 cylinder      | .....\$ 44.00 ea. |
| 64-09912 | 64    | 6 cyl. with AC      |                   |
|          | 64-66 | V8                  | .....\$ 44.00 ea. |
| 67-09914 | 67    | 6 cylinder          | .....\$ 44.00 ea. |
| 67-09915 | 67    | V8 without A/C      | .....\$ 44.00 ea. |
| 67-09916 | 67    | all, with AC        | .....\$ 44.00 ea. |
| 68-09914 | 68-69 | 6 cylinder          | .....\$ 44.00 ea. |
| 68-09912 | 68-69 | S/B                 | .....\$ 44.00 ea. |
| 68-09913 | 68    | B/B                 | .....\$ 44.00 ea. |
| 69-09913 | 69    | B/B                 | .....\$ 44.00 ea. |
| 69-09917 | 70    | 6 cylinder          | .....\$ 44.00 ea. |
| 70-09912 | 70    | S/B                 | .....\$ 44.00 ea. |
| 70-09913 | 70    | B/B                 | .....\$ 44.00 ea. |
| 71-09914 | 71    | S/B, side post      | .....\$ 48.00 ea. |
| 72-09915 | 72    | S/B, 307, side post | .....\$ 48.00 ea. |
| 72-09916 | 72    | S/B, 350, side post | .....\$ 48.00 ea. |

## BATTERY CABLES



### NEGATIVE

|          |       |                     |                   |
|----------|-------|---------------------|-------------------|
| 62-09920 | 62    | all                 |                   |
|          | 64    | V8                  |                   |
|          | 65    | all                 | .....\$ 44.00 ea. |
| 63-09920 | 63-64 | 4 & 6 cylinder      | .....\$ 44.00 ea. |
| 66-09920 | 66    | 6 cyl. without AC   |                   |
|          | 66    | V8 cylinder         | .....\$ 44.00 ea. |
| 66-09921 | 66-67 | 6 cyl. with AC      | .....\$ 44.00 ea. |
| 67-09923 | 67    | 6 cyl. without AC   | .....\$ 44.00 ea. |
| 67-09922 | 67    | V8 all              | .....\$ 44.00 ea. |
| 68-09923 | 68    | 6 cyl. without A/C  | .....\$ 44.00 ea. |
| 68-09924 | 68    | 6 cyl. with A/C     | .....\$ 44.00 ea. |
| 68-09925 | 68    | SB without A/C      | .....\$ 44.00 ea. |
| 68-09926 | 68    | SB with A/C         | .....\$ 44.00 ea. |
| 68-09927 | 68    | BB                  | .....\$ 44.00 ea. |
| 69-09927 | 69    | 6 cyl. without A/C  | .....\$ 44.00 ea. |
| 69-09928 | 69    | 6 cyl. with A/C     | .....\$ 44.00 ea. |
| 69-09929 | 69-70 | S/B                 | .....\$ 44.00 ea. |
| 69-09930 | 69    | B/B                 | .....\$ 44.00 ea. |
| 70-09931 | 70    | S/B, side post      | .....\$ 48.00 ea. |
| 70-09932 | 70    | B/B                 | .....\$ 44.00 ea. |
| 71-09929 | 71    | S/B, side post      |                   |
|          | 72    | S/B, 307, side post | .....\$ 48.00 ea. |
| 72-09929 | 72    | S/B, 350, side post | .....\$ 48.00 ea. |

## DISTRIBUTORS



Original rebuilt distributors.

|          |       |                 |                    |
|----------|-------|-----------------|--------------------|
| 67-10001 | 62-73 | V8, rebuilt     | .....\$ 85.00 ea.  |
| 74-10001 | 74-79 | V8,HEI, rebuilt | .....\$ 180.00 ea. |

✦ The following items require additional shipping and handling.

# CHEVROLET NOVA PARTS



Car Shop Inc. 739 North Batavia Orange, California 92868

## DISTRIBUTORS



### "Flame Thrower" Billet performance distributor

Replace your outdated points or electronic distributor with this performance proven distributor which features the patented Ignitor II electronics and a CNC machined 6061 T-6 Polished billet aluminum housing. V8. "Flame Thrower II" coil is recommended.

- 67-10002 62-73 V8, with black cap . . . . \$ 259.00 ea.  
 67-100021 62-73 V8, with red cap . . . . \$ 259.00 ea.



### "Flame Thrower" Billet performance distributor

- 74-10002 V8, with H.E.I. . . . . \$ 259.00 ea.



### RPC high performance distributor

- 74-100021 V8, with H.E.I. . . . . \$ 95.00 ea.

### CFR high performance distributor

- 74-100022 V8, with H.E.I. . . . . \$ 79.00 ea.

## DISTRIBUTOR HOLD DOWN



Includes wire clamp, plate and bolt. Replacement for some years.

- 67-10003 62-74 . . . . . \$ 14.00 kit



Steel plate style clamp.

- 65-10003 65-74 . . . . . \$ 10.00 ea.

## CHROME DISTRIBUTOR HOLD DOWN KIT



- 67-10004 62-74 chrome . . . . . \$ 5.00 kit

## DISTRIBUTOR GASKET



- 67-100045 64-74 V8 . . . . . \$ 2.00 ea.

## DISTRIBUTOR CAPS



- 67-10007 62-74 6-cylinder, Standard . . . \$ 7.00 ea.  
 67-100071 62-74 6-cylinder, AC Delco . . . \$ 11.00 ea.



- 67-10008 64-73 V8, Standard . . . . . \$ 10.00 ea.  
 67-100081 64-73 V8, AC Delco . . . . . \$ 18.00 ea.

## DISTRIBUTOR CAPS



Correct reproduction, "Delco-Remy PATENT PENDING".

- 67-100082 64-73 V8 . . . . . \$ 65.00 ea.



- 74-10008 74-79 V8, HEI, Standard . . . . \$ 11.00 ea.  
 74-100081 74-79 V8, HEI, AC Delco . . . . \$ 17.00 ea.

## DISTRIBUTOR ROTOR



- 67-10009 62-74 6-cylinder, Standard . . . \$ 4.00 ea.  
 67-100091 62-74 6-cylinder, AC Delco . . . \$ 8.00 ea.



- 67-10010 64-73 V8, Standard . . . . . \$ 4.00 ea.  
 67-100101 64-73 V8, AC Delco . . . . . \$ 7.00 ea.  
 74-10010 74-79 V8, HEI, Standard . . . . \$ 4.00 ea.  
 74-100101 74-79 V8, HEI, AC Delco . . . . \$ 6.00 ea.

## DISTRIBUTOR CONTACT POINTS



- 67-10011 62-74 6-cylinder, Standard . . . \$ 6.00 ea.  
 67-100111 62-74 6-cylinder, AC Delco . . . \$ 15.00 ea.  
 67-10012 64-73 V8, Standard . . . . . \$ 6.00 ea.  
 67-100121 64-73 V8, AC Delco . . . . . \$ 24.00 ea.

\* The following items require additional shipping and handling.



# CHEVROLET NOVA PARTS

Car Shop Inc. 739 North Batavia Orange, California 92868

## DISTRIBUTOR CONDENSER



- |           |       |                            |              |
|-----------|-------|----------------------------|--------------|
| 67-10013  | 62-74 | 6-cylinder, Standard . . . | \$ 12.00 ea. |
| 67-100131 | 62-74 | 6-cylinder, AC Delco . . . | \$ 15.00 ea. |
| 67-10014  | 64-73 | V8, Standard . . . . .     | \$ 4.00 ea.  |
| 67-100141 | 64-73 | V8, AC Delco . . . . .     | \$ 9.00 ea.  |

## COIL BRACKET BOLT KIT



Original "Anchor" headmark, (2) 5/16-18 x 3/4" bolts.

- |          |       |                            |             |
|----------|-------|----------------------------|-------------|
| 67-10017 | 62-73 | Coil bracket bolts . . . . | \$ 4.00 pr. |
|----------|-------|----------------------------|-------------|

## COIL BRACKETS



- |           |       |                 |             |
|-----------|-------|-----------------|-------------|
| 60-134023 | 62-72 | 6-cyl . . . . . | \$ 9.00 ea. |
|-----------|-------|-----------------|-------------|



- |           |       |                     |              |
|-----------|-------|---------------------|--------------|
| 67-10016  | 64-73 | V8, zinc . . . . .  | \$ 16.00 ea. |
| 67-100162 | 64-73 | V8, black . . . . . | \$ 11.00 ea. |



10-24 x 1 1/2, cadmium plated.

- |           |       |                           |             |
|-----------|-------|---------------------------|-------------|
| 67-100163 | 64-73 | V8, pinch screw . . . . . | \$ 5.00 ea. |
|-----------|-------|---------------------------|-------------|



- |          |       |                      |             |
|----------|-------|----------------------|-------------|
| 67-10018 | 64-73 | V8, chrome . . . . . | \$ 5.00 ea. |
|----------|-------|----------------------|-------------|

### Showroom hours:

**TUESDAY - FRIDAY: 8:30AM to 4:30PM**  
**SATURDAY: 8:30AM to 3:30PM**

### Phone order desk hours:

**MONDAY - FRIDAY: 8:30AM to 4:30PM**

## DISTRIBUTOR POINTS CONVERSION KIT



### "Ignitor" Electronic Ignition Kit, with coil

Never change points again. The Ignitor replaces breaker points with a dependable, self contained and maintenance free electronic ignition system. Quick installation. Fits under stock distributor caps.

Includes Black "Flame Thrower" coil.

- |          |       |                      |               |
|----------|-------|----------------------|---------------|
| 67-10005 | 62-73 | 6-cylinder . . . . . | \$ 139.00 kit |
| 67-10006 | 64-73 | V8 . . . . .         | \$ 136.00 kit |



Includes Chrome "Flame Thrower" coil.

- |           |       |                      |               |
|-----------|-------|----------------------|---------------|
| 67-100061 | 62-73 | 6-cylinder . . . . . | \$ 144.00 kit |
| 67-100062 | 64-73 | V8 . . . . .         | \$ 140.00 kit |



### "Ignitor II" Electronic Ignition Kit, with coil

The Ignitor II adds a powerful microcontroller to adjust the dwell. variable dwell helps to maintain peak energy throughout the entire RPM range. Up to 4 times more energy between 3000 and 5000 RPM.

Includes Black "Flame Thrower II" coil.

- |           |       |              |               |
|-----------|-------|--------------|---------------|
| 67-100051 | 62-73 | V8 . . . . . | \$ 172.00 kit |
|-----------|-------|--------------|---------------|

Includes Chrome "Flame Thrower II" coil.

- |           |       |              |               |
|-----------|-------|--------------|---------------|
| 67-100052 | 62-73 | V8 . . . . . | \$ 177.00 kit |
|-----------|-------|--------------|---------------|

## COIL



- |           |       |                           |              |
|-----------|-------|---------------------------|--------------|
| 67-10101  | 62-73 | Stock, Standard . . . . . | \$ 20.00 ea. |
| 67-101011 | 62-73 | Stock, AC Delco . . . . . | \$ 53.00 ea. |

## COIL



- |           |       |                         |              |
|-----------|-------|-------------------------|--------------|
| 67-101012 | 62-73 | Stock, chrome . . . . . | \$ 30.00 ea. |
|-----------|-------|-------------------------|--------------|



### "Flame Thrower" high performance coil

Perfect coil to match Ignitor electronic ignition kit. 40,000 volts. 1.5 OHM.

- |          |       |                               |              |
|----------|-------|-------------------------------|--------------|
| 67-10102 | 62-73 | Black, "Pertronix" . . . . .  | \$ 38.00 ea. |
| 67-10103 | 62-73 | Chrome, "Pertronix" . . . . . | \$ 43.00 ea. |

3.0 OHM.

- |           |       |                               |              |
|-----------|-------|-------------------------------|--------------|
| 67-101022 | 62-73 | Black, "Pertronix" . . . . .  | \$ 38.00 ea. |
| 67-101032 | 62-73 | Chrome, "Pertronix" . . . . . | \$ 43.00 ea. |

### "Flame Thrower II" high performance coil

Perfect coil to match Ignitor II electronic ignition kit. 45,000 volts. 0.6 OHM.

- |           |       |                               |              |
|-----------|-------|-------------------------------|--------------|
| 67-101021 | 62-73 | Black, "Pertronix" . . . . .  | \$ 43.00 ea. |
| 67-101031 | 62-73 | Chrome, "Pertronix" . . . . . | \$ 48.00 ea. |



- |           |       |                             |              |
|-----------|-------|-----------------------------|--------------|
| 74-10102  | 74-79 | V8, HEI, Standard . . . . . | \$ 23.00 ea. |
| 74-101021 | 74-79 | V8, HEI, AC Delco . . . . . | \$ 76.00 ea. |

## IGNITION COIL COVER



- |           |       |                             |              |
|-----------|-------|-----------------------------|--------------|
| 67-101022 | 74-79 | V8, HEI, Standard . . . . . | \$ 8.00 ea.  |
| 67-101023 | 74-79 | V8, HEI, AC Delco . . . . . | \$ 15.00 ea. |

+ The following items require additional shipping and handling.

# CHEVROLET NOVA PARTS



Car Shop Inc. 739 North Batavia Orange, California 92868

## IGNITION MODULE



- 74-100065 74-79 V8, HEI, Standard . . . \$ 21.00 ea.
- 74-100066 74-79 V8, HEI, AC Delco . . . \$ 45.00 ea.

## H.E.I. LEAD PIGTAILS



Contains coil lead & tach lead pigtails. Can also be used to modify 1967-1973 harnesses to work with H.E.I. distributors.

- 67-100145 coil lead & tach lead . . . . . \$ 7.00 pr.

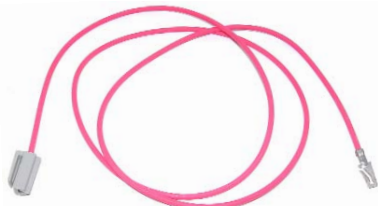

- 67-100146 pink lead wire . . . . . \$ 6.00 ea.

## DISTRIBUTOR VACUUM ADVANCE LINES



- 67-10105 62-70 6 cylinder . . . . . \$ 12.00 ea.



- 59-08722 64 283, 327 V8 . . . . . \$ 15.00 ea.



- 66-10106 66 283, 2 bbl. . . . . \$ 15.00 ea.



- 67-10109 67-69 Small block, 2 bbl. . . . \$ 12.00 ea.

## DISTRIBUTOR VACUUM ADVANCE LINES



- 67-10106 67-70 327, 350, 4 bbl. Quadra-Jet . . . . \$ 12.00 ea.



- 67-10107 68-72 Big block, 4 bbl. Quadra-Jet . . . . \$ 12.00 ea.

## VACUUM ADVANCE HOSE AND TUBE KIT



Includes 2 rubber hoses, 1 metal tube (with correct bends and flares) and 1 clip that retains metal tube.

- 67-10110 S/B with Holley & Z/28 or LT-1 intake . . . \$ 22.00 kit
- 67-101101 66-69 327, 350, Q-jet . . . . . \$ 22.00 kit



- 67-10112 68-69 396 hp, 4 bbl. Q-Jet . . . \$ 22.00 kit
- 67-10111 68-69 396/375 hp, Holley . . . \$ 22.00 kit

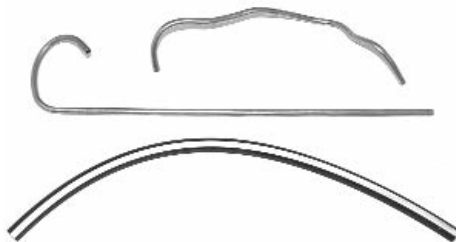

- 70-07705 70-72 Big Block Holley, WTCS . . . . . \$ 32.00 kit
- 70-077051 70-72 Big Block Q-Jet, WTCS . . . . . \$ 32.00 kit

\*TCS = Throttle Control Solenoid.

## DISTRIBUTOR VACUUM ADVANCE UNIT



- 67-10015 64-73 V8 . . . . . \$ 19.00 ea.
- 67-100151 62-67 6 cyl. . . . . \$ 15.00 ea.
- 68-100152 68-72 6 cyl. . . . . \$ 29.00 ea.

## VACUUM ADVANCE LINE RETAINER CLIP



- 67-10104 62-70 All . . . . . \$ 5.00 ea.

## HEADLIGHT SWITCHES



- 58-05803 62-64 . . . . . \$ 20.00 ea.



- 67-10113 65-73 . . . . . \$ 12.00 ea.
- 70-10117 74-79 . . . . . \$ 12.00 ea.

## HEADLIGHT SWITCH RETAINING NUT



- 69-10118 68-79 . . . . . \$ 8.50 ea.

## HEADLIGHT SWITCH NUT TOOL



- 69-14805 62-65 . . . . . \$ 9.00 ea.
- 66-14805 66-67 . . . . . \$ 9.00 ea.

+ The following items require additional shipping and handling.





# CHEVROLET NOVA PARTS

Car Shop Inc. 739 North Batavia Orange, California 92868

## HEADLIGHT KNOB AND ROD

- |   |   |
|---|---|
|    |  |
| 61-05809 62-63 .....  | \$ 12.00 ea.  |
|    |  |
| 64-05810 64 .....   | \$ 12.00 ea.  |
|    |  |
| 65-05810 65-66 .....  | \$ 14.00 ea.  |
|    |  |
| 67-10119 67 with chrome knob .....  | \$ 8.00 ea.   |
|  |   |
| 68-07723 68 .....   | \$ 23.00 ea.  |
|  |   |
| 69-10120 69-70 .....  | \$ 14.00 ea.  |
|  |   |
| 71-10121 71-78 .....  | \$ 19.00 ea.  |

## HEADLIGHT DIMMER SWITCH

- |   |  |
|---|--|
|  |  |
| 67-10123 62-79 .....  | \$ 5.00 ea.  |





## HEADLIGHT DIMMER PIGTAIL

- |   |             |
|---|-------------|
|  |             |
| 67-10124 62-79 .....  | \$ 2.50 ea. |

## DIMMER SWITCH THRU CARPET GROMMET

- |   |             |
|---|-------------|
|  |             |
| 67-101241 62-79 Black .....   | \$ 6.00 ea. |



## HORN RELAY

- |   |              |
|---|--------------|
|   |              |
| 58-11201 62 .....   | \$ 20.00 ea. |
|  |              |
| 64-07802 63-65 .....  | \$ 25.00 ea. |
|  |              |
| 67-10200 66-71 reproduction no logo .....   | \$ 32.00 ea. |
|  |              |
| Correct reproduction features Delco-Remy logo.                                      |              |
| 67-102012 66-71 with logo .....   | \$ 69.00 ea. |



## HORN RELAY

- |   |              |
|---|--------------|
|  |              |
| 72-10200 72-73 .....  | \$ 49.00 ea. |
|  |              |
| 74-10200 74-75 .....  | \$ 11.00 ea. |

## HORN MOUNTING BOLTS

- |  |             |
|--|-------------|
|   |             |
| "WB" headmark, (1) 5/16-18 x 1" bolt, lock washer and flat washer.                   |             |
| 67-10203 62-74 .....   | \$ 2.00 ea. |
|  |             |
| "Anchor" headmark, 5/16-18 x 7/8, 1/2 hex, with .75 toothed washer.                  |             |
| 67-102031 62-74 pointed tip .....  | \$ 4.00 pr. |

## HORNS

- |  |              |
|--|--------------|
|                     |              |
| 67-10125 62-74 High note, replacement  | \$ 18.00 ea. |
| 67-10126 62-74 Low note, replacement   | \$ 18.00 ea. |
|                     |              |
| Correct reproduction horns. New horns feature "Delco Remy" logo. Replacement mounting brackets included. |              |
| 67-10129 62-74 High & Low note .....   | \$ 99.00 pr. |



# CHEVROLET NOVA PARTS



Car Shop Inc. 739 North Batavia Orange, California 92868

## IGNITION SWITCH



Keys and cylinder not included.

62-04710 62-64 .....\$ 15.00 ea.  
64-05731 65 replacement .....\$ 17.00 ea.



67-10204 66-67 Reproduction .....\$ 17.00 ea.  
67-102041 66-67 Original GM .....\$ 44.00 ea.  
67-102042 68 Reproduction .....\$ 17.00 ea.  
68-10205 68 Original GM .....\$ 33.00 ea.



69-10206 69-79 Without tilt wheel ....\$ 25.00 ea.  
69-10207 69-79 With tilt wheel .....\$ 22.00 ea.

## IGNITION LOCK WITH KEYS



Ignition switch cylinder lock with 2 keys.

64-10710 62-64 with "GM" keys .....\$ 11.00 ea.  
65-10711 65 .....\$ 13.00 ea.



67-14609 66-67 .....\$ 15.00 ea.  
68-14610 68 .....\$ 18.00 ea.  
69-14611 69-78 .....\$ 15.00 ea.

## IGNITION SWITCH BEZEL



62-04613 62-64 chrome .....\$ 9.00 ea.

## IGNITION SWITCH BEZEL NUT



62-05727 62-65 chrome, 3-slots .....\$ 6.00 ea.



65-04617 65 chrome, 4-slots .....\$ 28.00 ea.  
66-04617 66 chrome, 4-slots .....\$ 28.00 ea.



67-10209 67 chrome, 3-slots .....\$ 7.00 ea.



68-10209 68 stainless steel, 3-slots ..\$ 38.00 ea.

## IGNITION BEZEL NUT TOOL



67-10208 62-67 With 3-slots .....\$ 9.00 ea.  
66-07821 65-66 With 4-slots .....\$ 9.00 ea.



68-10208 68 With 4-slots .....\$ 11.00 ea.

## VOLTAGE REGULATOR GROUND WIRE



Correct gauge, color and connectors.

67-10214 62-72 .....\$ 12.00 ea.

## VOLTAGE REGULATOR



62-10211 62 with generator .....\$ 82.00 ea.  
67-10211 63-72 exc. 61-63 amp alt. ....\$ 67.00 ea.  
67-102112 63-72 with 61-63 amp alt. ....\$ 69.00 ea.

## VOLTAGE REGULATOR BOLTS

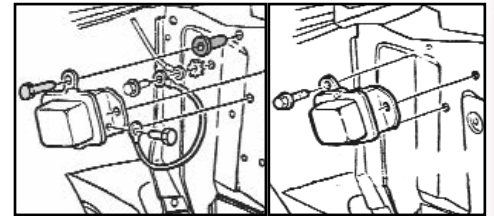

1963-68

1969-72



10-24 x 1, 5/16 hex, with shoulder.

67-102121 63-68 3 pieces .....\$ 5.00 set



69-102121 69-72 3 pieces .....\$ 2.50 set

## VOLTAGE REGULATOR WELL NUTS



67-10212 63-68 Regulator well nut  
(3 required) .....\$ 1.25 ea.

## VOLTAGE REGULATOR MOUNTING KIT



Kit includes 3 shouldered mounting bolts and 3 well nuts.

67-10213 63-68 .....\$ 8.00 kit

## BRAKE LIGHT SWITCH



67-10215 62-79 Without cruise control ..\$ 5.00 ea.



67-10216 64-74 With cruise control ...\$ 17.00 ea.

## BRAKE LIGHT SWITCH RETAINER



67-10217 68-74 .....\$ 2.00 ea.

+ The following items require additional shipping and handling.

Fax Order 1-714-771-0407 • Toll Free 1-800-235-2470 • [www.TruckandCarShop.com](http://www.TruckandCarShop.com) • 2014 Catalog



# CHEVROLET NOVA PARTS

Car Shop Inc. 739 North Batavia Orange, California 92868

## TURN SIGNAL FLASHER



- 67-10218 62-74 3 prong .....\$ 6.00 ea.  
 For use with L.E.D. park lights & tail lights.  
 67-102181 62-74 3 prong .....\$ 10.00 ea.

## TURN SIGNAL LEVERS

- TAQGO**  
 61-05407 62 .....\$ 12.00 ea.
- TAQGO**  
 63-05409 63-66 .....\$ 12.00 ea.
- TAQGO**  
 67-10219 67 .....\$ 11.00 ea.
- TAQGO**  
 68-10220 68-70 .....\$ 11.00 ea.  
 71-10221 71-74 .....\$ 15.00 ea.

## TILT COLUMN RELEASE LEVERS

- 67-10222 67 .....\$ 16.00 ea.
- 68-10223 68-70 .....\$ 16.00 ea.  
 71-10224 71-74 .....\$ 16.00 ea.

## TURN SIGNAL LEVER SCREW

- 67-10230 63-68 .....\$ 1.50 ea.  
 69-10231 69-74 .....\$ 1.00 ea.

## SIMULATED WOOD STEERING WHEELS



- 1964-66 SIMULATED WOOD STEERING WHEEL**  
 Cap and mounting hardware sold separately.  
 64-08017 64-66 .....\$ 229.00 ea.



- SIMULATED WALNUT STEERING WHEEL**  
 67-10301 68 .....\$ 280.00 ea.



## SIMULATED WOOD STEERING WHEELS



- SIMULATED WALNUT STEERING WHEEL KIT**  
 Includes steering wheel, mounting hub, horn cap and wood wheel mounting kit.  
 67-10302 68 .....\$ 355.00 kit



- SIMULATED ROSEWOOD STEERING WHEEL**  
 69-10303 69-70 .....\$ 280.00 ea.



- ROSEWOOD STEERING WHEEL KIT**  
 Includes steering wheel, mounting hub, horn cap and wood wheel mounting kit.  
 69-10304 69-70 With tilt .....\$ 355.00 kit  
 69-10305 69-70 Without tilt .....\$ 355.00 kit

+ The following items require additional shipping and handling.

# CHEVROLET NOVA PARTS



Car Shop Inc. 739 North Batavia Orange, California 92868

## COMFORT GRIP STEERING WHEEL



### COMFORT GRIP STEERING WHEEL

Original option for 1969-72.

- 69-10306 67-72 Black .....\$ 139.00 ea.
- 69-103061 67-72 Red .....\$ 169.00 ea.
- 69-103062 67-72 Light blue .....\$ 169.00 ea.



### COMFORT GRIP STEERING WHEEL KIT

Includes steering wheel, mounting hub, horn cap, horn contact plate steering wheel to hub screws & contact screws.

- 67-10307 67-68 Black .....\$ 215.00 kit
- 69-10307 69-72 Black .....\$ 215.00 kit

## STEERING WHEELS



### 1967 STANDARD STEERING WHEEL

Horn cap and hardware sold separately.

Black with chrome shroud.

- 67-10309 67 .....\$ 245.00 ea.

Black with silver shroud.

- 68-10310 68 .....\$ 245.00 ea.

## STEERING WHEELS



### 1967 "SS" DELUXE STEERING WHEEL

Steering wheel & brushed shroud only.

- 67-08020 67 Wheel & shroud only ...\$ 284.00 pr.



### 1967 SS DELUXE STEERING WHEEL KIT

Includes: steering wheel, brushed shroud, horn cap, horn buttons, horn contacts, horn cap & installation kit.

- 67-08021 67 Steering wheel kit .....\$ 375.00 kit



### 1969-72 STANDARD STEERING WHEEL

- 69-10311 69-70 Black .....\$ 215.00 ea.
- 69-103111 69-70 Dark Blue .....\$ 215.00 ea.
- 69-103112 69-70 Red .....\$ 215.00 ea.
- 69-103113 69-70 Dark Green .....\$ 215.00 ea.

## STEERING WHEELS



### 1969-72 STANDARD STEERING WHEEL KIT

Kit includes steering wheel, shroud, buttons and contacts.

Center emblem sold separately.

- 69-10312 69-70 Black steering wheel with black shroud ....\$ 278.00 kit
- 69-10313 69-70 Black steering wheel with rosewood shroud ..\$ 284.00 kit
- 69-103131 69-70 Dark Blue .....\$ 278.00 kit
- 69-103132 69-70 Red .....\$ 278.00 kit
- 69-103133 69-70 Dark Green .....\$ 278.00 kit



Includes steering wheel & shroud with SS emblem.

- 71-081035 71-74 Black .....\$ 259.00 kit



- 67-107042 71-74 Horn contact wire .....\$ 9.00 ea.

**Showroom hours:**  
**TUESDAY - FRIDAY: 8:30AM to 4:30PM**  
**SATURDAY: 8:30AM to 3:30PM**  
**Phone order desk hours:**  
**MONDAY - FRIDAY: 8:30AM to 4:30PM**

+ The following items require additional shipping and handling.

Fax Order 1-714-771-0407 • Toll Free 1-800-235-2470 • [www.TruckandCarShop.com](http://www.TruckandCarShop.com) • 2014 Catalog



# CHEVROLET NOVA PARTS

Car Shop Inc. 739 North Batavia Orange, California 92868

## HORN CAPS & EMBLEMS



Horn cap emblem only.

63-10314 63-64 Super Sport .....\$ 29.00 ea.



Fits standard steering wheel, complete cap & emblem.

67-10320 67 SS, chrome .....\$ 27.00 ea.  
67-10321 67 SS-350, chrome .....\$ 27.00 ea.  
68-10322 68 SS, silver .....\$ 26.00 ea.



Fits Deluxe SS steering wheel horn cap, emblem only.

67-08118 67 "SS" .....\$ 33.00 ea.



Fits Deluxe SS steering wheel, complete cap & emblem.

67-081181 67 "SS" .....\$ 52.00 ea.



Fits simulated wood steering wheel.

66-08115 64-66 US made .....\$ 47.00 ea.

## HORN CAPS & EMBLEMS



Fits simulated wood or comfort grip steering wheels.

67-10401 67-72 import .....\$ 30.00 ea.  
67-104011 67-72 US made .....\$ 44.00 ea.

## 4 SPOKE STEERING WHEEL HORN CAPS & EMBLEMS



With out emblem

73-10323 73-78 Black .....\$ 13.00 ea.



Horn cap plastic emblem.

73-10415 73-78 Bow-Tie, black with silver rings .....\$ 23.00 ea.

73-104151 73-78 All black with silver Bow-Tie .....\$ 20.00 ea.



73-10416 73-78 "SS" .....\$ 23.00 ea.

## 4 SPOKE STEERING WHEEL HORN CAP RETAINER



Mounts inside horn cap.

73-10419 73-78 Retainer .....\$ 6.00 ea.

## STEERING WHEEL SHROUD

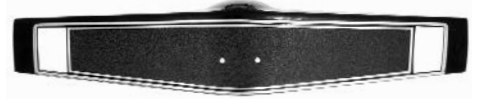

Fits standard steering wheel only.

69-10402 69-70 Black .....\$ 59.00 ea.  
69-104031 69-70 Dark Blue .....\$ 59.00 ea.  
69-104032 69-70 Red .....\$ 59.00 ea.  
69-104033 69-70 Dark Green .....\$ 59.00 ea.



69-10403 69-70 Rosewood .....\$ 64.00 ea.

## STEERING WHEEL SHROUD SCREW KIT



69-104035 69-70 shroud screw kit .....\$ 2.50 kit

## STEERING WHEEL HORN BUTTONS



Fits standard steering wheel only.

69-10404 69-70 Black .....\$ 13.00 pr.  
69-104041 69-70 Dark Blue .....\$ 13.00 pr.  
69-104042 69-70 Red .....\$ 13.00 pr.  
69-104043 69-70 Dark Green .....\$ 13.00 pr.

## HORN BUTTON CONTACTS



These are the metal contacts used to activate the horn.

Fits standard steering wheel only.

69-10405 69-70 .....\$ 20.00 set

# CHEVROLET NOVA PARTS



Car Shop Inc. 739 North Batavia Orange, California 92868

## STEERING WHEEL SHROUD EMBLEMS



For deluxe steering wheels with push button horn contacts.  
**68-10412** 68 SS .....\$ 20.00 ea.



For deluxe steering wheels with push button horn contacts.  
**68-10412** 68 SS-396 .....\$ 28.00 ea.



**69-10412** 69-70 Black with blue Bow-tie . \$ 13.00 ea.



**69-10414** 69 SS .....\$ 10.00 ea.



**70-10414** 70 SS .....\$ 13.00 ea.

## HORN CAP RETAINER & CONTACT KIT



Fits standard steering wheels  
**67-10417** 67-68 .....\$ 20.00 kit

## HORN CAP MOUNTING RING



Rubber mounting ring used to mount the horn cap on standard wheels.  
 2 7/16" diameter.

**67-10418** 67-68 .....\$ 5.00 ea.

## 1967 SS HORN CAP MOUNTING KIT



For deluxe SS steering wheels with push button horn contacts.  
**67-08101** 67 .....\$ 29.00 kit

## 1967 SS STEERING WHEEL HORN BUTTONS



Fits Deluxe SS steering wheel.  
**67-08104** 67 Chrome .....\$ 30.00 pr.

## 1967 SS STEERING WHEEL HORN BUTTON CONTACTS



These are the metal contacts used to activate the horn.  
 Fits SS steering wheel.  
**67-08106** 67 .....\$ 20.00 pr.

## HORN CAP MOUNTING KIT



Fits Wood & accessory comfort grip steering wheels.  
 Mounts steering wheel to hub & horn cap to wheel.  
**67-10503** 67-68 All .....\$ 25.00 kit

## HORN CAP MOUNTING KIT



Fits Wood & accessory comfort grip steering wheels.  
 Mounts steering wheel to hub & horn cap to wheel.  
**69-10504** 69-72 Without tilt .....\$ 28.00 kit  
**69-10505** 69-72 With tilt .....\$ 28.00 kit

## STEERING WHEEL MOUNTING HUB



Mounts optional simulated wood steering wheel to the steering column.  
 3 11/16" diameter, 1 7/8" tall, replaces GM #3828382  
**64-08201** 64-66 .....\$ 50.00 ea.



Mounts optional simulated wood or comfort grip steering wheel to the steering column.  
 3 15/16" diameter, 1 7/8" tall, replaces GM #3930062  
**67-10501** 67-68 .....\$ 34.00 ea.



Mounts optional simulated wood or comfort grip steering wheel to the steering column.  
 4 1/8" diameter, 1 3/16" tall, replaces GM #3937896.  
**69-10502** 69-72 .....\$ 34.00 ea.

## HORN PIN, SPRING & RETAINER



**69-105051** 69-79 .....\$ 5.00 kit

+ The following items require additional shipping and handling.

Fax Order 1-714-771-0407 • Toll Free 1-800-235-2470 • [www.TruckandCarShop.com](http://www.TruckandCarShop.com) • 2014 Catalog



# CHEVROLET NOVA PARTS

Car Shop Inc. 739 North Batavia Orange, California 92868

## HORN CAP CONTACT



Attaches horn cap, fits simulated wood or comfort grip wheels.

64-10506 64-66 .....\$ 31.00 ea.



69-10506 67-72 .....\$ 14.00 ea.

## TURN SIGNAL CANCELLING CAM



62-10507 62-65 .....\$ 20.00 ea.



67-10507 67-68 With tilt .....\$ 28.00 ea.



69-10507 69-72 with tilt .....\$ 15.00 ea.

69-10508 69-72 without tilt .....\$ 15.00 ea.

## LOWER HORN CONTACT



58-05603 62-66 .....\$ 5.00 ea.

## UPPER STEERING COLUMN BEARING



63-05617 63 without tilt .....\$ 15.00 ea.



64-05618 64-66 without tilt .....\$ 21.00 ea.

## UPPER STEERING COLUMN SHAFT BEARING



This bearing is used for the upper steering column shaft. GM #7800269.  
69-05617 69-74 without tilt .....\$ 22.00 ea.



This bearing is used for the upper steering column shaft. GM #5696210.  
1967-68 lower upper, 1969-74 2 required, upper or lower.  
67-05618 67-74 with tilt .....\$ 15.00 ea.

## STEERING COLUMN LOWER BEARING



Lower steering column plastic insert bushing & retainer clip.  
67-10515 67-68 w/o tilt .....\$ 25.00 ea.



Lower steering column plastic bearing retainer, bearing & retainer clip.  
69-10515 69-76 all .....\$ 37.00 ea.



Lower steering column plastic bearing retainer.  
69-05619 69-76 all .....\$ 8.00 ea.

## STEERING COLUMN SPONGE SEAL



62-10510 62-66 .....\$ 9.00 ea.

67-105101 67 .....\$ 9.00 ea.

67-10510 68 .....\$ 4.00 ea.

69-10511 69-72 .....\$ 4.00 ea.

## STEERING COLUMN CLAMP PLATE



69-105113 69-72 .....\$ 42.00 ea.

## STEERING COLUMN SEAL FASTENER KIT



67-10530 68 5 pieces .....\$ 6.00 kit



69-10531 69-72 6 pieces .....\$ 7.00 kit

## STEERING COLUMN TO FLOOR SEAL



62-10512 62-67 .....\$ 18.00 ea.



67-10512 68-74 .....\$ 13.00 ea.

## STEERING COLUMN TO DASH FASTENER KIT



67-102075 68 9 pieces .....\$ 5.50 kit



69-102076 69-74 6 pieces .....\$ 5.50 kit

## CARPET FIREWALL GUARD

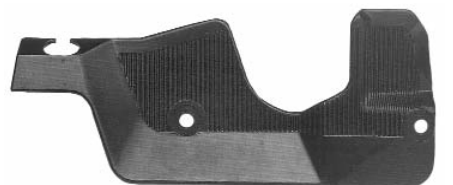

67-02845 69-72 .....\$ 23.00 ea.





\* The following items require additional shipping and handling.

# CHEVROLET NOVA PARTS



Car Shop Inc. 739 North Batavia Orange, California 92868

## STEERING COLUMN COVER TO FIREWALL SCREW KIT

- |   |   |          |             |
|---|---|----------|-------------|
|  |  |          |             |
| 67-02846  | 68  | 2 pieces | \$ 3.50 pr. |
|  |  |          |             |
| 69-02846  | 69-72   | 2 pieces | \$ 3.50 pr. |

## TURN SIGNAL SWITCHES

- |   |    |  |              |
|---|----|--|--------------|
|  |    |  |              |
|   |    |  |              |
| Replaces GM #3765110.   |    |  |              |
| 59-05313  | 62 |  | \$ 17.00 ea. |

- |  |                    |  |              |
|--|--------------------|--|--------------|
|  |                    |  |              |
|  |                    |  |              |
| Replaces GM #898197.   |                    |  |              |
| 63-05314   | 63-64 <sup>E</sup> |  | \$ 50.00 ea. |

- |   |       |  |              |
|---|-------|--|--------------|
|  |       |  |              |
|   |       |  |              |
| Replaces GM #910821, includes upper bearing.  |       |  |              |
| 64-053151   | 64-65 |  | \$ 42.00 ea. |

- |  |    |       |              |
|--|----|-------|--------------|
|   |    |       |              |
|   |    |       |              |
| Replaces GM #387115, features metal housing with plastic cam.  |    |       |              |
| Note: On 1966 cars without tilt wheel, you must check to see what letters are stamped into the plastic on the switch, ("BPC"). |    |       |              |
| 64-08001   | 66 | "BPC" | \$ 70.00 ea. |

## TURN SIGNAL SWITCHES



- Replaces GM #9110051, features plastic housing with plastic cam.  
 Note: On 1966 cars without tilt wheel, you must check to see what letters are stamped into the plastic on the switch, ("GUIDE").
- |          |    |         |              |
|----------|----|---------|--------------|
| 64-08002 | 66 | "GUIDE" | \$ 44.00 ea. |
|----------|----|---------|--------------|

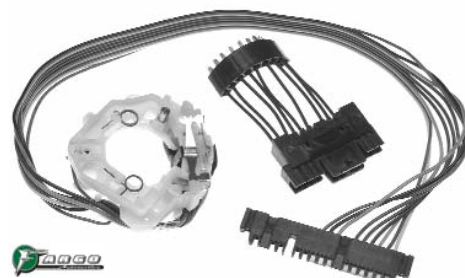

- Replaces GM #1893592, Delco #D6211.  
 This a service part, adapter pigtail included and is required.
- |          |       |  |              |
|----------|-------|--|--------------|
| 67-10516 | 67-68 |  | \$ 38.00 ea. |
|----------|-------|--|--------------|



- Replaces GM #7800482. No adapter needed.
- |          |       |             |              |
|----------|-------|-------------|--------------|
| 67-10517 | 67-68 | floor shift | \$ 42.00 ea. |
|----------|-------|-------------|--------------|
- Replaces GM #5698897. No adapter needed.
- |          |       |              |              |
|----------|-------|--------------|--------------|
| 67-10518 | 67-68 | column shift | \$ 42.00 ea. |
|----------|-------|--------------|--------------|

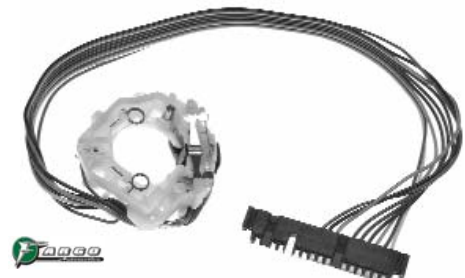

- Replaces GM #1997938.
- |          |       |  |              |
|----------|-------|--|--------------|
| 69-10517 | 69-72 |  | \$ 32.00 ea. |
|----------|-------|--|--------------|

• Car Shop •  
 • Best Quality • Best Price •

## TURN SIGNAL SWITCH REPAIR KITS







- Includes die cast ring, pawls, spring & bushing
- |          |    |  |              |
|----------|----|--|--------------|
| 61-05330 | 62 |  | \$ 27.00 ea. |
|----------|----|--|--------------|

## TURN SIGNAL RING PIVOT BOLT

- |   |    |               |             |
|---|----|---------------|-------------|
|  |    |               |             |
|  |    |               |             |
| 59-05328  | 62 | shoulder bolt | \$ 3.00 ea. |

## TURN SIGNAL SWITCH LEVER REPAIR CAM

- |   |    |  |             |
|---|----|--|-------------|
|  |    |  |             |
|  |    |  |             |
| "C" shaped cam on switch assembly   |    |  |             |
| 63-05331  | 63 |  | \$ 4.00 ea. |

- |   |       |  |             |
|---|-------|--|-------------|
|  |       |  |             |
|  |       |  |             |
| "C" shaped cam on switch assembly   |       |  |             |
| 64-05332  | 64-65 |  | \$ 4.00 ea. |

- |   |       |  |             |
|---|-------|--|-------------|
|  |       |  |             |
|  |       |  |             |
| 67-10518  | 67-68 |  | \$ 4.00 ea. |
| 69-10519  | 69-74 |  | \$ 4.00 ea. |

## HAZARD KNOB

- |   |       |                      |              |
|---|-------|----------------------|--------------|
|  |       |                      |              |
| 67-10520  | 67-68 | Chrome, short design | \$ 9.00 ea.  |
|  |       |                      |              |
| 67-105202   | 67-70 | Chrome, long design  | \$ 13.00 ea. |
|  |       |                      |              |
| 69-10521  | 69-77 | Black                | \$ 8.00 ea.  |

† The following items require additional shipping and handling.

Fax Order 1-714-771-0407 • Toll Free 1-800-235-2470 • [www.TruckandCarShop.com](http://www.TruckandCarShop.com) • 2014 Catalog



# CHEVROLET NOVA PARTS

Car Shop Inc. 739 North Batavia Orange, California 92868

## 4-WAY HAZARD FLASHER SWITCH



62-10520 62 ..... \$ 200.00 ea.

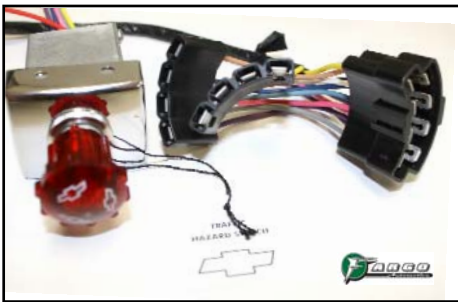

63-10520 63 ..... \$ 200.00 ea.

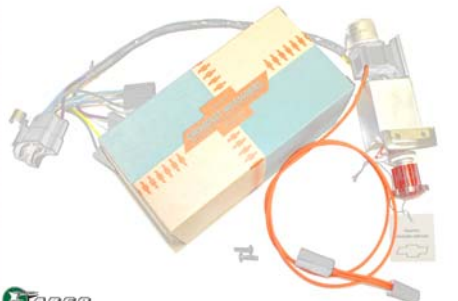

64-10520 64 ..... \$ 200.00 ea.



65-10520 65 ..... \$ 200.00 ea.

66-10520 66 ..... \$ 200.00 ea.

## CPP PAINTABLE STEEL TILT COLUMNS



New Classic Performance Products steering columns.  
5-way adjusting tilt columns, 2" dia. stainless steel tube, 3/4-36 spline output shaft, includes 3 & 4-speed shift indicator lenses.

62-10570 62-66 Column Shift ..... \$ Call ea.

67-10571 67 Column Shift ..... \$ Call ea.



5-way adjusting tilt column, 2" diameter stainless steel tube, 3/4-36 spline output shaft.

62-10575 62-67 Floor Shift ..... \$ Call ea.

## CPP TILT COLUMN INSTALL KITS



This kit has all the essentials for installing a 400 series steering box on your early Nova.

Fits original column shift column & 400 series steering box.

62-10576 62-66 ..... \$ 144.00 kit

Fits original floor shift column & 400 series steering box.

62-10577 62-66 ..... \$ 115.00 kit

Fits aftermarket 3/4-36 spline column & 400 series steering box.

62-10578 62-66 ..... \$ 159.00 kit

Fits aftermarket (hollow 1" DD) column & 400 series steering box.

62-10579 62-66 ..... \$ 159.00 kit

## IDIDIT PAINTABLE STEEL TILT COLUMNS



New Ididit steering columns

62-10580 62-66 Column Shift ..... \$ 645.00 ea.

67-10581 67 Column Shift ..... \$ 645.00 ea.

69-10582 69-73 Column Shift with key ..... \$ 879.00 ea.



New Ididit steering columns

62-10583 62-66 Floor Shift ..... \$ 399.00 ea.

67-10584 67 Floor Shift ..... \$ 399.00 ea.

69-10585 69-73 Floor Shift with key ..... \$ 639.00 ea.

## IDIDIT CHROME STEEL TILT COLUMNS



New Ididit steering columns

62-10590 62-66 Column Shift ..... \$ 519.00 ea.

67-10591 67 Column Shift ..... \$ 519.00 ea.

69-10592 69-73 Column Shift with key ..... \$ 739.00 ea.

+ The following items require additional shipping and handling.



# CHEVROLET NOVA PARTS

Car Shop Inc. 739 North Batavia Orange, California 92868



## IDIDIT CHROME STEEL TILT COLUMNS



New Ididit steering columns

|          |       |                         |       |           |     |
|----------|-------|-------------------------|-------|-----------|-----|
| 62-10593 | 62-66 | Floor Shift             | ..... | \$ 789.00 | ea. |
| 67-10594 | 67    | Floor Shift             | ..... | \$ 789.00 | ea. |
| 69-10595 | 69-73 | Floor Shift<br>with key | ..... | \$1059.00 | ea. |

## ORIGINAL GM TILT COLUMN



Reconditioned original columns

|           |       |                            |       |           |     |
|-----------|-------|----------------------------|-------|-----------|-----|
| 69-10604  | 69-74 | Column Shift               | ..... | \$ 399.00 | ea. |
| 69-10605  | 69-74 | Floor Shift, auto trans.   | ..    | \$ 399.00 | ea. |
| 69-106051 | 69-74 | Floor Shift, manual trans. |       | \$ 399.00 | ea. |

## IDIDIT TILT COLUMN FILLER PLATE



Fills the gap under a stock steering wheel on an IDIDIT column.  
Includes horn contact & spring.

|           |       |       |          |     |
|-----------|-------|-------|----------|-----|
| 64-150015 | 62-67 | ..... | \$ 25.00 | ea. |
|-----------|-------|-------|----------|-----|

## BILLET STEERING WHEEL HORN CONTACT WIRE



|           |       |         |     |
|-----------|-------|---------|-----|
| 67-107042 | ..... | \$ 9.00 | ea. |
|-----------|-------|---------|-----|

## BILLET ALUMINUM STEERING WHEELS



Made from machined aluminum and then chromed for a beautiful shine.  
Each wheel is available with a leather or simulated burlwood half wrap.  
14 inch.

**Cruiser Style**

|           |               |       |           |     |
|-----------|---------------|-------|-----------|-----|
| 67-106061 | Black Leather | ..... | \$ 219.00 | ea. |
| 67-106062 | Gray Leather  | ..... | \$ 235.00 | ea. |
| 67-106063 | Red Leather   | ..... | \$ 235.00 | ea. |
| 67-106064 | Burlwood      | ..... | \$ 235.00 | ea. |



**Retro Style**

|           |               |       |           |     |
|-----------|---------------|-------|-----------|-----|
| 67-106071 | Black Leather | ..... | \$ 219.00 | ea. |
| 67-106072 | Gray Leather  | ..... | \$ 235.00 | ea. |
| 67-106073 | Red Leather   | ..... | \$ 235.00 | ea. |
| 67-106074 | Burlwood      | ..... | \$ 235.00 | ea. |



**Shadow Style**

|           |               |       |           |     |
|-----------|---------------|-------|-----------|-----|
| 67-106081 | Black Leather | ..... | \$ 219.00 | ea. |
| 67-106082 | Gray Leather  | ..... | \$ 235.00 | ea. |
| 67-106083 | Red Leather   | ..... | \$ 235.00 | ea. |
| 67-106084 | Burlwood      | ..... | \$ 235.00 | ea. |

## BILLET ALUMINUM STEERING WHEELS



Made from machined aluminum and then chromed for a beautiful shine.  
Each wheel is available with a leather or simulated burlwood half wrap.  
14 inch.

**Bandit Style**

|           |               |       |           |     |
|-----------|---------------|-------|-----------|-----|
| 67-106091 | Black Leather | ..... | \$ 219.00 | ea. |
| 67-106092 | Gray Leather  | ..... | \$ 235.00 | ea. |
| 67-106093 | Red Leather   | ..... | \$ 235.00 | ea. |
| 67-106094 | Burlwood      | ..... | \$ 235.00 | ea. |



**Tracker Style**

|           |               |       |           |     |
|-----------|---------------|-------|-----------|-----|
| 67-106095 | Black Leather | ..... | \$ 219.00 | ea. |
| 67-106096 | Gray Leather  | ..... | \$ 235.00 | ea. |
| 67-106097 | Red Leather   | ..... | \$ 235.00 | ea. |
| 67-106098 | Burlwood      | ..... | \$ 235.00 | ea. |

## BILLET STEERING WHEEL MOUNTING HUB



Billet machined steering wheel hub, chrome plated, includes steering wheel to hub mounting screws with allen wrench and horn contact wire.

|          |       |            |       |          |     |
|----------|-------|------------|-------|----------|-----|
| 67-10701 | 67-79 | Chrome hub | ..... | \$ 59.00 | ea. |
|----------|-------|------------|-------|----------|-----|

## BILLET STEERING WHEEL HORN CAP



Billet machined horn cap, chrome plated.

|           |                 |       |          |     |
|-----------|-----------------|-------|----------|-----|
| 67-107041 | chrome horn cap | ..... | \$ 50.00 | ea. |
|-----------|-----------------|-------|----------|-----|

✦ The following items require additional shipping and handling.

Fax Order 1-714-771-0407 • Toll Free 1-800-235-2470 • [www.TruckandCarShop.com](http://www.TruckandCarShop.com) • 2014 Catalog



# CHEVROLET NOVA PARTS

Car Shop Inc. 739 North Batavia Orange, California 92868

## POWER STEERING PUMP BRACKETS

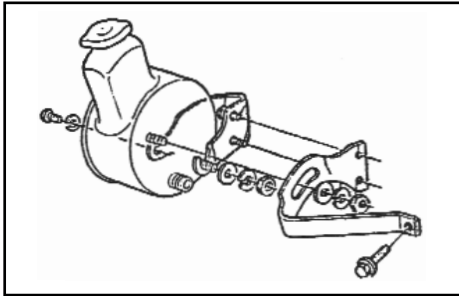

1964-1968 Small Block

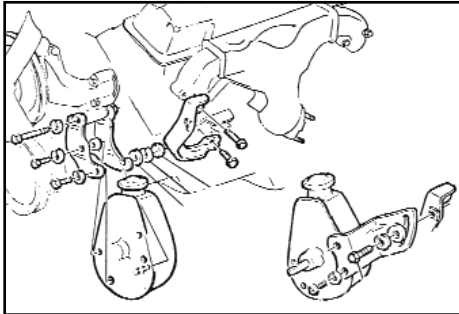

1969-1976 Small Block

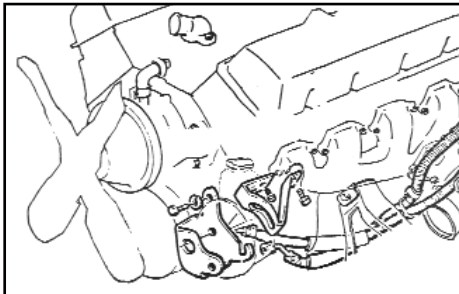

1968 Big Block

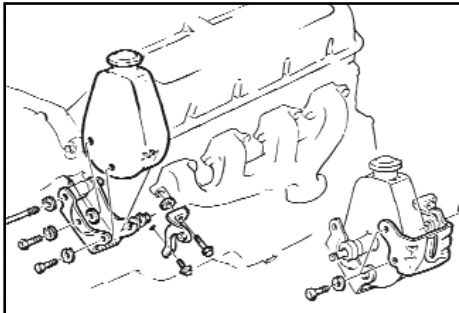

1969 Big Block

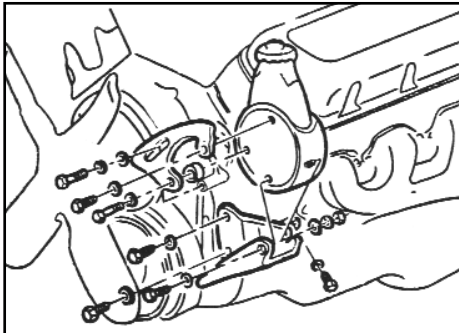

1970-1972 Big Block

## POWER STEERING PUMP BRACKETS



Will fit all small blocks with short water pump and 8-inch balancer.  
67-10705 64-68 S/B ..... \$ 46.00 pr.



61-09826 65-67 Adjuster bracket, S/B ... \$ 37.00 ea.



67-10706 68 S/B, adjuster, with 327 ... \$ 25.00 ea.



67-10707 68 B/B, adjuster ..... \$ 32.00 ea.



67-10708 64-68 S/B, cradle bracket ... \$ 46.00 ea.



67-10709 68 B/B, cradle bracket ... \$ 62.00 ea.



69-10710 69-76 S/B, cradle bracket ... \$ 23.00 ea.

## POWER STEERING PUMP BRACKETS



69-10711 69-76 S/B, rear adjuster, on block ..... \$ 28.00 ea.



69-10712 69-76 S/B, adjuster, on pump ... \$ 24.00 ea.



69-10714 69-76 S/B bracket kit, 3-pc. ... \$ 69.00 kit



Bracket to pump spacer, .25 thick x .40 ID & .73 O.D.  
69-10713 69-76 S/B ..... \$ 4.00 ea.



69-10715 69 B/B, bracket kit, 3-pc. ... \$ 55.00 kit



70-10716 70-72 B/B, cradle bracket ... \$ 30.00 ea.



70-10717 70-72 B/B, adjuster bracket ... \$ 25.00 ea.

# CHEVROLET NOVA PARTS



Car Shop Inc. 739 North Batavia Orange, California 92868

## POWER STEERING PUMP BRACKET BOLTS



Includes 2 mounting bolts and 2 lock washers, and 1 adjuster bolt.  
Original headmark. use with Part # 67-10705.

67-10801 64-68 .....\$ 4.00 set



Includes 2 bolts and 2 lock washers, grade 5.  
Original "Double circle" headmark, 7/16-14 x 1".

67-10802 68 B/B .....\$ 5.00 pr.

## POWER STEERING PUMP CAP



67-108032 62-72 metal .....\$ 31.00 ea.



67-10803 62-79 GM replacement .....\$ 10.00 ea.



67-108031 62-79 replacement with raised lettering ...\$ 6.00 ea.

## POWER STEERING PUMP SEAL KIT



67-10804 62-79 with bushing .....\$ 18.00 kit

67-10805 62-79 without bushing .....\$ 14.00 kit

## NEW POWER STEERING PUMPS



### BLACK POWER STEERING PUMPS

These 100% brand new pumps and reservoirs have a beautiful OEM appearance and function. Reservoirs come with all o-rings and fittings, including an AN adapter, if necessary to install in your application.

|           |       |            |                    |
|-----------|-------|------------|--------------------|
| 61-09807  | 62-67 | All        | .....\$ 135.00 ea. |
| 67-108061 | 68-69 | 6-cylinder | .....\$ 139.00 ea. |
| 67-108071 | 68    | S/B        | .....\$ 139.00 ea. |
| 69-108081 | 69    | S/B        | .....\$ 139.00 ea. |
| 69-108091 | 69    | B/B        | .....\$ 139.00 ea. |
| 70-108101 | 70-74 | V8         | .....\$ 139.00 ea. |



### CHROME POWER STEERING PUMPS

100% brand new pumps and reservoirs.

|           |       |            |                    |
|-----------|-------|------------|--------------------|
| 61-098072 | 62-67 | All        | .....\$ 155.00 ea. |
| 67-108062 | 68-69 | 6-cylinder | .....\$ 155.00 ea. |
| 67-108072 | 68    | S/B        | .....\$ 155.00 ea. |
| 69-108082 | 69    | S/B        | .....\$ 155.00 ea. |
| 69-108092 | 69    | B/B        | .....\$ 155.00 ea. |



70-108102 70-74 V8 .....\$ 149.00 ea.

## REBUILT POWER STEERING PUMPS



Rebuilt original power steering pumps.

|          |       |            |                    |
|----------|-------|------------|--------------------|
| 67-10806 | 68-69 | 6-cylinder | .....\$ 135.00 ea. |
| 67-10807 | 68    | S/B        | .....\$ 135.00 ea. |
| 69-10808 | 69    | S/B        | .....\$ 135.00 ea. |
| 69-10809 | 69    | B/B        | .....\$ 135.00 ea. |



70-10810 70-74 V8 .....\$ 135.00 ea.

## POWER STEERING HOSE CLIP



67-10821 68-74 on box .....\$ 9.00 ea.



This clip holds both the power steering and return hose together. These are sprung steel heat treated. Most models use 2 clips per car.  
67-108195 68-74 .....\$ 5.50 ea.

## POWER STEERING PULLEY NUT



67-10822 62-78 .....\$ 2.50 ea.

+ The following items require additional shipping and handling.

Fax Order 1-714-771-0407 • Toll Free 1-800-235-2470 • [www.TruckandCarShop.com](http://www.TruckandCarShop.com) • 2014 Catalog



# CHEVROLET NOVA PARTS

Car Shop Inc. 739 North Batavia Orange, California 92868

## POWER STEERING CYLINDER HOSES



62-10812 62-67 All .....\$ 88.00 pr.

## POWER STEERING PUMP TO CONTROL VALVE HOSES



62-10813 62-67 6-cylinder .....\$ 89.00 pr.  
62-10814 62-67 V8 .....\$ 89.00 pr.

## POWER STEERING PRESSURE HOSES



*Pressure Hose*  
67-10812 68 All .....\$ 31.00 ea.  
69-10814 69 V8 .....\$ 23.00 ea.  
69-10813 69 6-cylinder .....\$ 30.00 ea.  
70-10814 70-72 V8 .....\$ 25.00 ea.  
70-10813 70-73 6-cylinder .....\$ 22.00 ea.  
73-10814 73-74 V8 .....\$ 24.00 ea.

## POWER STEERING RETURN HOSES



*Return Hose*  
67-10818 62-74 .....\$ 18.00 ea.

## POWER STEERING HOSE BRACKETS



*Power steering hose to frame guide bracket set.*  
60-09915 62-67 .....\$ 39.00 set

## POWER STEERING PUMP PULLEY



*Fits 3rd groove on crank pulley, stock for most cars.*  
67-10823 62-78 single groove .....\$ 37.00 ea.

*Fits 2nd groove on crank pulley, works with double groove crank pulley.*  
67-108231 62-78 single groove .....\$ 44.00 ea.



67-10824 68 B/B, single groove, deep,  
Cast iron .....\$ 135.00 ea.



69-10825 69-78 Double groove .....\$ 40.00 ea.



69-10826 69-70 396/375 HP  
single, deep groove ...\$ 48.00 ea.



67-10827 62-78 Single groove, chrome ..\$ 24.00 ea.

## POWER STEERING CONTROL VALVE SEAL KIT



58-09911 62-67 .....\$ 15.00 kit

## POWER STEERING CONTROL VALVE



58-09909 62-67 .....\$ 199.00 ea.

## POWER STEERING CONTROL VALVE DUST BOOT



*Power steering control valve rubber boot with metal retainer.*  
58-09910 62-67 boot & retainer .....\$ 12.00 ea.



*Power steering control valve metal dust cap.*  
58-099101 62-67 dust cap .....\$ 5.00 ea.

## POWER STEERING CONTROL VALVE BALL STUD REPLACEMENT KIT



58-099111 62-67 .....\$ 49.00 kit

## POWER STEERING CYLINDER



58-09723 62-67 .....\$ 169.00 ea.

## POWER STEERING SLAVE CYLINDER SEAL KIT



58-09801 62-67 .....\$ 12.00 kit

## POWER STEERING SLAVE CYLINDER MOUNTING KIT



58-09802 62-67 .....\$ 11.00 kit

+ The following items require additional shipping and handling.

# CHEVROLET NOVA PARTS



Car Shop Inc. 739 North Batavia Orange, California 92868

## MANUAL STEERING GEAR BOX



All new! not rebuilt!

67-10901 68-76 ..... \$ 349.00 ea.

## POWER STEERING GEAR BOX



Our 400 Series Box for your Nova is truly the best of its kind. New compact design, an easy bolt on alternative to rack & pinion systems or other style boxes.

62-109022 62-67 400 steering box ..... \$ 379.00 ea.



Our 500 Series Box for your Nova is truly the best of its kind. A direct replacement for the factory power steering box or an easy way to upgrade from manual steering to power steering. The 14 to 1 ratio adds a new dimension of handling to your car, smooth operation and excellent road feedback.

67-109022 68-76 500 steering box ..... \$ 379.00 ea.

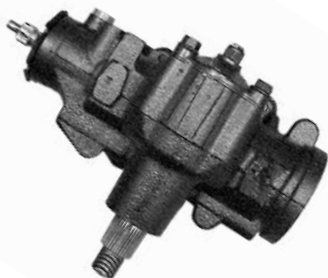

Rebuilt original units.

67-10902 68-76 4 turns ..... \$ 275.00 ea.

67-10903 68-76 quick ratio,  
3 turns ..... \$ 275.00 ea.

## POWER STEERING CONVERSION KIT



Includes 400 Series power steering box, power steering pump, cap, pulley, 2-pieces bracket kit & conversion hoses.

Box features 3/4-30 spline input shaft.

62-10850 62-67 V8, SB ..... \$ 599.00 kit

## STEERING BOX BOLT KIT



62-109032 62-67 15 pieces ..... \$ 12.00 kit



67-109032 68-76 6 pieces ..... \$ 13.00 kit

## POWER STEERING GEAR BOX REBUILD KIT



67-10905 68-72 ..... \$ 54.00 ea.

## STEERING COUPLER DISC KIT



This includes one disc and four mounting bolts.

67-10906 68-76 ..... \$ 13.00 kit

## STEERING COUPLER



Fits 400 series steering box.

62-10907 62-67 3/4-30 X 3/4-36 ..... \$ 98.00 ea.

62-10908 62-67 3/4-30 X 3/4-DD ..... \$ 98.00 ea.



67-10907 68-76 with power steering . . . \$ 32.00 ea.

67-10908 68-76 without power steering . . \$ 39.00 ea.



67-109081 68-74 with tilt, upper ..... \$ 44.00 ea.

## STEERING COUPLER BOLT



67-109085 68-76 clamp bolt ..... \$ 3.50 ea.

## STEERING COUPLER/RAG JOINT NUT KIT



67-109086 68-76 4 pieces ..... \$ 3.00 kit



† The following items require additional shipping and handling.

Fax Order 1-714-771-0407 • Toll Free 1-800-235-2470 • [www.TruckandCarShop.com](http://www.TruckandCarShop.com) • 2014 Catalog



# CHEVROLET NOVA PARTS

Car Shop Inc. 739 North Batavia Orange, California 92868

## STEERING ARMS



When converting your 4-lug car to disc brakes using our stock disc brake kit, you will need to change your spindles to 5-lug spindles and steering arms. The 5-lug spindles and steering arms bolt right on using your existing ball joints.

62-10930 62-67 LH & RH .....\$ 70.00 pr.



67-10930 68-74 LH & RH .....\$ 70.00 pr.

## PITMAN ARM



63-10909 63-67 manual steering .....\$ 75.00 ea.



67-10909 68-72 With P/S .....\$ 54.00 ea.

67-10911 68-72 Without P/S .....\$ 74.00 ea.

73-10909 73-74 With P/S .....\$ 49.00 ea.

## PITMAN ARM NUT & LOCK WASHER



67-109102 62-74 .....\$ 4.00 pr.

## TIE ROD BOOTS



67-10914 62-74 Urethane, black .....\$ 5.00 pr.



67-10915 62-74 Rubber, black .....\$ 2.00 ea.

## TIE RODS



### Outer Tie Rods

62-09616 62 LH or RH  
1st design, short .....\$ 26.00 ea.



62-10917 62 LH or RH  
2nd design, long, USA ..\$ 99.00 ea.



63-10916 63-67 LH or RH .....\$ 25.00 ea.



67-10916 68-74 LH or RH .....\$ 20.00 ea.



### Inner Tie Rods

62-09627 62 LH or RH  
1st design, long .....\$ 100.00 ea.



62-09616 62 LH or RH  
2nd design, short .....\$ 26.00 ea.



63-09627 63-67 LH or RH .....\$ 20.00 ea.

67-10919 68-74 LH or RH .....\$ 22.00 ea.

## TIE ROD ADJUSTING SLEEVE



58-097021 62-67 LH or RH .....\$ 11.00 ea.



67-11001 68-74 LH or RH .....\$ 9.00 ea.

## CENTERLINK (DRAGLINK)



67-11003 68-74 .....\$ 89.00 ea.

## IDLER ARM FRAME BRACKET

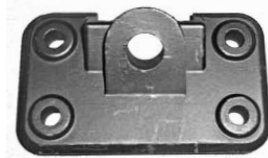

63-11005 63-67 manual steering .....\$ 42.00 ea.

## IDLER ARM



62-11006 62 .....\$ 149.00 ea.



63-11006 63-67 .....\$ 79.00 ea.



Upgraded design will eliminate the steering play associated with the original design. Includes premium Duraleen bushings, frame mount bracket & sleeves for centerlink.

63-110062 63-67 .....\$ 130.00 ea.

# CHEVROLET NOVA PARTS



Car Shop Inc. 739 North Batavia Orange, California 92868

## IDLER ARM



68-11006 68-74 .....\$ 59.00 ea.

## IDLER ARM BUSHINGS



62-11007 63-67 frame side .....\$ 15.00 ea.  
62-110071 63-67 centerlink side .....\$ 14.00 ea.

## IDLER ARM TO CENTERLINK BOLT KIT



63-110061 63-67 .....\$ 29.00 ea.

## IDLER ARM BOLT KIT



62-110061 62-65 16 pieces .....\$ 7.00 kit



66-110061 66-67 12 pieces .....\$ 7.00 kit



3/8-16 x 1 1/4, grade 8.

67-110061 68-74 .....\$ 6.50 kit

## BALL JOINTS

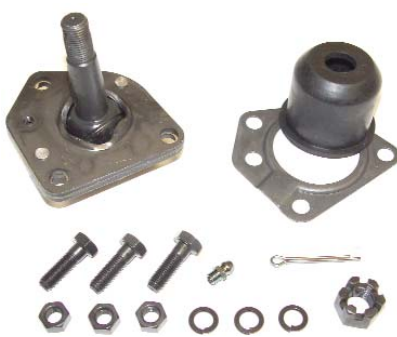

62-11008 62-67 upper, LH or RH import .....\$ 38.00 ea.

62-110081 62-67 upper, LH or RH made in USA .....\$ 54.00 ea.



67-11008 68-74 upper, LH or RH import .....\$ 16.00 ea.

67-110081 68-74 upper, LH or RH made in USA .....\$ 32.00 ea.



62-11010 62-67 lower, LH or RH import .....\$ 42.00 ea.

62-110101 62-67 lower, LH or RH made in USA .....\$ 65.00 ea.



67-11010 68-74 lower, LH or RH import .....\$ 16.00 ea.

67-110101 68-74 lower, LH or RH made in USA .....\$ 36.00 ea.

## BALL JOINT RIVET BOLT SET



This is a set of 8 rivet style bolts that attach the ball joint to the upper control arm and gives it the appearance of a real rivet

67-110081 68-74 .....\$ 20.00 set

## GREASE FITTING KIT



67-110082 62-74 10 pieces .....\$ 3.50 kit

## GREASE FITTING PLUGS



67-110083 62-74 6 pieces .....\$ 4.50 kit

## BALL JOINT BOOT SET



67-10913 68-74 Urethane, set of 4, black . \$ 8.00 set

## CASTLE NUT KITS



62-110105 62-67 24 pieces .....\$ 12.00 kit



67-110105 68-74 20 pieces .....\$ 11.00 kit

+ The following items require additional shipping and handling.

Fax Order 1-714-771-0407 • Toll Free 1-800-235-2470 • [www.TruckandCarShop.com](http://www.TruckandCarShop.com) • 2014 Catalog



# CHEVROLET NOVA PARTS

Car Shop Inc. 739 North Batavia Orange, California 92868

## UPPER CONTROL ARM SHAFT & BUSHING KIT



62-11012 62-67 LH or RH  
made in USA .....\$ 144.00 ea.



67-11012 68-74 LH or RH .....\$ 55.00 ea.

## UPPER CONTROL ARM BUSHING



62-11015 62-67 .....\$ 11.00 ea.  
67-11015 68-74 .....\$ 6.00 ea.

## LOWER CONTROL ARM BUSHING



62-11020 62-67 Bushing .....\$ 20.00 ea.  
62-110201 62-67 Bushing cap, 4 per car . \$ 3.00 ea.  
67-11020 68-72 Front of arm  
73-74 all .....\$ 8.00 ea.  
67-11021 68-72 Rear of arm .....\$ 8.00 ea.

## POLYURETHANE CONTROL ARM BUSHING KIT



67-11024 68-74 8 pieces, black .....\$ 77.00 kit

## LOWER CONTROL ARM STRUT ROD



62-11027 62-67 .....\$ 60.00 ea.

## LOWER STRUT ROD BUSHING KIT



62-11025 62-67 stock .....\$ 19.00 kit



62-11026 62-67 improved design .....\$ 36.00 kit

## LOWER CONTROL ARM STRUT ROD NUT KIT



62-11037 62-67 4 pieces .....\$ 11.00 kit

## STRUT ROD TO LOWER CONTROL ARM BOLT KIT



62-11038 62-67 12 pieces .....\$ 11.00 kit

## LOWER CONTROL ARM CAM BOLT KIT



Correct reproduction, 1 pair required for original control arms,  
2 pair required for CPP mini sub-frame.

62-11028 62-67 .....\$ 25.00 pr.

## LOWER ALIGNMENT LOCK OUT KIT



Kit eliminates alignment cams & provides 13 different positions for the  
control arm. They will never slip and cause a lost alignment.

62-110281 62-67 .....\$ 38.00 kit

## FRONT END REBUILD KITS



### ORIGINAL RUBBER KIT

Includes all of the following:

- 2 Upper Ball Joints
- 2 Lower Ball Joints
- 4 Upper A-Arm Bushings
- 2 Lower A-Arm, Front Bushings
- 2 Lower A-Arm, Rear Bushings
- 2 Inner Tie Rods
- 2 Outer Tie Rods
- 2 Tie Rod Adjusting Sleeves
- 2 Upper A-Arm Bumpers
- 2 Lower A-Arm Bumpers
- 2 Sway Bar End Link Kits

This kit contains original rubber bushings.

68-11026 68-74 .....\$ 239.00 kit



### POLYURETHANE KIT

Includes all of the following:

- 2 Upper Ball Joints
- 2 Lower Ball Joints
- 4 Upper A-Arm Bushings (poly.)
- 2 Lower A-Arm, Front Bushings (poly.)
- 2 Lower A-Arm, Rear Bushings (poly.)
- 2 Inner Tie Rods
- 2 Outer Tie Rods
- 2 Tie Rod Adjusting Sleeves
- 2 Upper A-Arm Bumpers
- 2 Lower A-Arm Bumpers
- 2 Sway Bar End Link Kits (poly.)

This kit contains polyurethane bushings.

68-11028 68-74 .....\$ 269.00 kit



# CHEVROLET NOVA PARTS



Car Shop Inc. 739 North Batavia Orange, California 92868

## FRONT END MINI REBUILD KIT



Includes all of the following:

- 2 Upper Ball Joints
- 2 Lower Ball Joints
- 4 Upper Control Arm Bushing
- 2 Lower Control Arm, Front Bushings
- 2 Lower Control Arm, Rear Bushings

This kit contains original rubber bushings.

67-11101 68-74 .....\$ 109.00 kit

## A-ARMS



Our A-arms come with ball joints pre installed.

66-11105 66-67 LH, upper .....\$ 149.00 ea.

66-11106 66-67 RH, upper .....\$ 149.00 ea.



Our A-arms come with ball joints pre installed.

67-11105 68-74 LH, upper .....\$ 119.00 ea.

67-11106 68-74 RH, upper .....\$ 119.00 ea.



Our A-arms come with ball joints pre installed.

66-11107 66-67 LH, lower .....\$ 139.00 ea.

66-11108 66-67 RH, lower .....\$ 139.00 ea.



67-11107 68-74 LH, lower .....\$ 119.00 ea.

67-11108 68-74 RH, lower .....\$ 119.00 ea.

## TUBULAR A-ARMS



CPP's quality upper and lower Totally Tubular™ control arms.

62-111052 62-67 LH & RH, upper, black  
made in USA .....\$ 309.00 pr.



Lower A-arm conversion kit, converts single arm to modern a-arm.

62-111072 62-67 LH & RH, lower, black  
made in USA .....\$ 399.00 kit



A-arms come with ball joints & bushings pre installed.

67-111052 68-74 LH, upper .....\$ 139.00 ea.

67-111062 68-74 RH, upper .....\$ 139.00 ea.



A-arms come with ball joints & bushings pre installed.

67-111072 68-74 LH, lower .....\$ 149.00 ea.

67-111082 68-74 RH, lower .....\$ 149.00 ea.

## TUBULAR A-ARMS



4 piece A-arm kit, with ball joints & bushings pre installed.

67-111073 68-74 .....\$ 449.00 kit

## TUBULAR A-ARM MINI SUB-FRAME KIT



Kit includes a 1/4" steel crossmember that bolts to the chassis in place of the factory strut rod mounts, eliminating the factory strut rods, and adding adjustable forward control arm mounts. This kit adds stability, alignability, improved steering response and over 2" of ground clearance for your early Nova.

62-111073 62-67 black .....\$ 699.00 kit

## TUBULAR A-ARM STEERING STOPS



When you want to add steering stops to your CPP tubular arms.

62-111074 62-67 LH & RH .....\$ 22.00 pr.



**NEW**  
2nd Location  
CONCORD NC

**Car Shop 2nd Location**  
2701 Derita Road Concord NC 28027 704-979-6490

† The following items require additional shipping and handling.

Fax Order 1-714-771-0407 • Toll Free 1-800-235-2470 • [www.TruckandCarShop.com](http://www.TruckandCarShop.com) • 2014 Catalog



# CHEVROLET NOVA PARTS

Car Shop Inc. 739 North Batavia Orange, California 92868

## CONTROL ARM BUMPERS



67-11112 62-67 lower .....\$ 14.00 ea.



67-11110 68-74 Upper .....\$ 3.00 ea.



68-11113 68-74 Lower .....\$ 7.00 ea.

## LOWER A-ARM BUMPER NUT KIT



67-111121 68-74 .....\$ 2.00 pr.

## A-ARM TO FRAME BOLT KIT



Upper A-arm shaft to frame serrated bolt kit.  
62-11103 62-67 8 pieces .....\$ 12.00 kit



Upper A-arm shaft to frame serrated bolt kit with shims.  
67-11103 68-74 .....\$ 15.00 kit



Lower A-arm to frame bolt kit.  
67-11104 68-74 .....\$ 22.00 kit

## UPPER A-ARM BUSHING RETAINER KIT

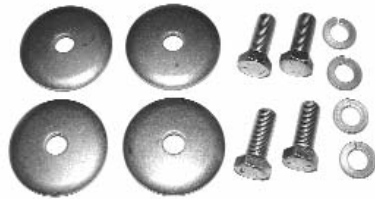

67-11102 68-72 .....\$ 10.00 kit

## FRONT END ALIGNMENT SHIM SET



67-11030 68-74 24 pcs, 3 assorted thicknesses .....\$ 8.00 set

## SUBFRAME



68-11041 68 .....\$ 979.00 ea.  
69-11042 69-74 .....\$ 979.00 ea.

## SUB FRAME REINFORCEMENT PLATES

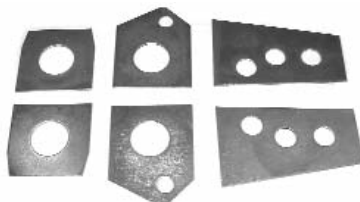

Reinforces corroded sub frames.  
67-11516 68-74 .....\$ 47.00 kit

## BODY MOUNT BUSHING KIT



This complete kit includes all of the rubber body mounts, steel insert sleeves and shouldered bushings used on the sub-frame. Includes radiator support bushings.

67-11512 68-72 .....\$ 42.00 kit

## BODY MOUNT BUSHING BOLT KIT



Includes all bolts and washers used when replacing your body mount bushings. Includes radiator support hardware.

67-11513 68-72 zinc, replacement .....\$ 20.00 kit



67-115131 68-72 Black oxide with correct bolts .....\$ 29.00 kit

## FRONT SHOCK MOUNTING BRACKET BOLT KIT



62-11135 62-67 24 pieces .....\$ 9.00 kit

+ The following items require additional shipping and handling.

# CHEVROLET NOVA PARTS



Car Shop Inc. 739 North Batavia Orange, California 92868

## FRONT SHOCK MOUNTING TOWERS



Includes hardware.

62-11126 62-67 LH or RH .....\$ 31.00 ea.

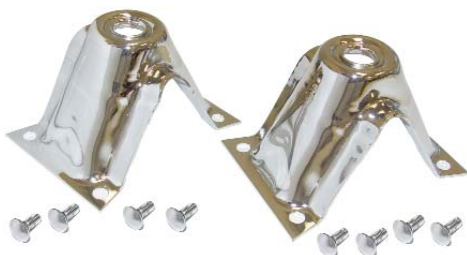

Includes hardware.

62-111261 62-67 Chrome, LH & RH ....\$ 67.00 pr.

## SHOCKS



62-11115 62-67 Front .....\$ 26.00 ea.



68-11115 68-79 Front .....\$ 31.00 ea.



62-11117 62-67 Rear .....\$ 26.00 ea.



68-11117 68-79 Rear, mono leaf .....\$ 24.00 ea.

64-08613 68-79 Rear, multi leaf .....\$ 25.00 ea.

## OE SPIRAL SHOCKS



67-11120 68-74 Front .....\$ 89.00 ea.

## FRONT SHOCK MOUNTING KIT



62-11127 62-67 upper .....\$ 10.00 kit



62-111271 62-67 lower .....\$ 10.00 kit



67-11127 68-74 lower .....\$ 8.00 kit

## REAR SHOCK MOUNTING BOLTS



62-11128 62-67 6 pieces .....\$ 5.00 kit



With mono leaf springs, lower.

67-11128 68-74 6 pieces .....\$ 4.50 kit

## REAR SHOCK MOUNTING HARDWARE



Upper bolt kit.

68-111291 68-74 4 pieces .....\$ 6.00 kit



With multi leaf springs, lower nut & lock washer kit.

68-11129 68-74 4 pieces .....\$ 3.50 kit

## SHOCK MOUNTING BOLT



Mounts to multi leaf shock mounting plate.

68-11412 68-74 .....\$ 7.00 ea.

## FRONT UPPER COIL SPRING INSULATORS



67-11216 68-79 .....\$ 12.00 ea.

## FRONT COIL SPRINGS



These top quality coil springs will help restore your cars original ride and steering. A must for virtually all Novas as the front of the car has a tendency to sag.

62-11203 62-67 6-cyl, 283 .....\$ 72.00 pr.

66-11203 66-67 327,350 & all wagons ..\$ 70.00 pr.

67-11203 68-74 6-cylinder without A/C ..\$ 85.00 pr.

67-11204 68-74 6-cylinder with A/C

68-74 S/B without A/C .....\$ 87.00 pr.

67-11206 68-74 S/B with A/C

68-72 B/B, all .....\$ 89.00 pr.

## Lowered coil springs

Lowers car 1-1/2 to 2 inches. Improves handling.

62-11214 62-67 .....\$ 109.00 pr.

62-11215 62-67 heavy duty .....\$ 119.00 pr.

68-11215 68-74 .....\$ 109.00 pr.

## EIBACH PERFORMANCE COIL SPRINGS



## Eibach Pro-Kit Lowering Springs

High Performance handling, lower center of gravity, progressive spring design, excellent ride quality, lowers car 1-1/2 to 2 inches.

67-11214 68-74 All .....\$ 199.00 pr.

+ The following items require additional shipping and handling.

Fax Order 1-714-771-0407 • Toll Free 1-800-235-2470 • [www.TruckandCarShop.com](http://www.TruckandCarShop.com) • 2014 Catalog



# CHEVROLET NOVA PARTS

Car Shop Inc. 739 North Batavia Orange, California 92868

## COIL SPRING PERCH



62-11240 62-67 .....\$ 22.00 ea.

## COIL SPRING PERCH NUT KIT



62-11241 62-67 8 pieces .....\$ 3.50 kit

## COIL SPRING UPPER SEAT



62-11242 62-67 .....\$ 25.00 ea.

## PRELUBE, FOR URETHANE PRODUCTS



Prevent squeaks! Apply prelube to all urethane products before assembly.  
67-11220 1 oz. ....\$ 3.50 ea.

## FRONT SWAY BAR END LINK KIT



With rubber bushings  
67-11217 62-79 .....\$ 14.00 pr.

With polyurethane bushings  
67-11218 62-79 .....\$ 22.00 pr.

## FRONT SWAY BAR BUSHING



Replacement style rubber bushings.

67-11219 68-74 With 3/4" bar .....\$ 8.00 pr.



OE style rubber bushings.

67-112191 63-69 With 11/16" bar .....\$ 21.00 pr.

## FRONT SWAY BAR BRACKETS



67-112195 68-74 front .....\$ 22.00 pr.

## GREASEABLE FRONT SWAY BAR BUSHING KIT



Greaseable bushing & bracket kit, with polyurethane bushings.

67-11221 68-74 With 5/8" bar .....\$ 24.00 pr.

67-11222 68-74 With 3/4" bar .....\$ 24.00 pr.

67-11223 68-74 With 7/8" bar .....\$ 24.00 pr.

67-11224 68-74 With 1" bar .....\$ 24.00 pr.

67-11225 68-74 With 1-1/8" bar .....\$ 24.00 pr.

67-11226 68-74 With 1-1/4" bar .....\$ 24.00 pr.

## FRONT SWAY BAR TO FRAME BOLT KIT



69-112262 68-74 4 pieces .....\$ 6.00 kit

## REAR SWAY BAR END BRACKET BOLT KIT



70-112263 70-72 F-41, 12 pieces .....\$ 6.00 kit

## HI PERFORMANCE ANTI-SWAY BAR KIT



62-11227 62-67 1" front .....\$ 149.00 kit

67-11227 68-74 1" front .....\$ 149.00 kit

67-11228 68-74 1-1/8" front .....\$ 149.00 kit

## REAR SWAY BAR KIT

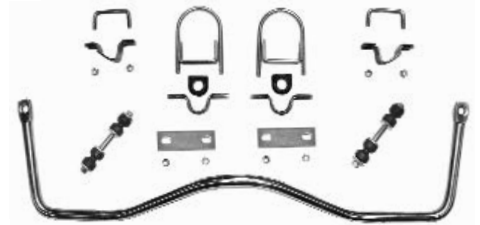

68-11303 68-74 .....\$ 139.00 kit

## LEAF SPRINGS

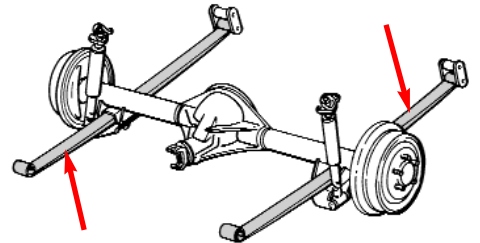

67-11305+ 68-74 Mono, coupe .....\$ 279.00 pr.

68-11307+ 68-74 4-Leaf .....\$ 259.00 pr.

67-11308+ 68-74 5-Leaf .....\$ 209.00 pr.

## LEAF SPRING SHACKLE KIT



This kit includes 2 shackle plates, 2 bolts, 2 nuts and 4 bushings.  
1 kit will do one side of the car.

67-11319 62-74 LH or RH .....\$ 31.00 kit

## LEAF SPRING SHACKLE BUSHING



Shackle bushings are used on the rear part of the spring.  
Order 8 pieces to do 1 car complete.

67-11321 62-74 .....\$ 4.00 ea.

# CHEVROLET NOVA PARTS



Car Shop Inc. 739 North Batavia Orange, California 92868

## LEAF SPRING PADS

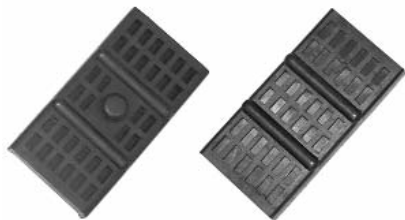

- 67-11311 68-74 Mono, upper .....\$ 6.00 ea.  
67-11312 68-74 Mono, lower .....\$ 7.00 ea.



- 68-11313 68-74 Multi, upper or lower ...\$ 6.00 ea.

## LEAF SPRING BOLTS



- 68-11316 68-74 U-bolts with multi leaf .....\$ 24.00 pr.



- 68-11317 68-74 T-bolt, 1-5/8" .....\$ 4.00 ea.

## LEAF SPRING TO AXLE FASTENER KIT



- 67-11330 62-67 with mono leaf .....\$ 26.00 kit  
68-74



- 67-11331 68-74 with multi leaf .....\$ 38.00 kit

## LEAF SPRING MOUNTING KIT



- 67-11323 68-74 With mono springs ...\$ 89.00 set  
68-11324 68-74 With multi springs 2 U-bolts, 4 T-bolts ...\$ 89.00 set  
68-113241 68-74 With multi springs with 4 U-bolts .....\$ 89.00 set

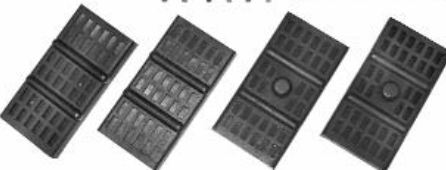

## LEAF SPRING REBUILD KIT

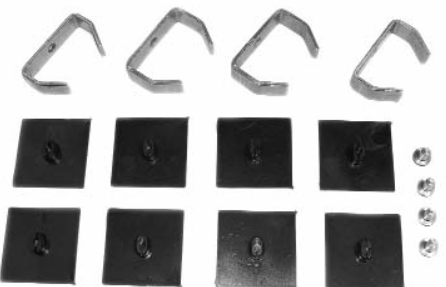

- This kit includes new straps, pads and rivet pins to re-assemble your leaf springs. For use with original factory springs only.  
68-11309 68-74 4-Leaf .....\$ 30.00 kit  
68-11310 68-74 5-Leaf .....\$ 39.00 kit

## LEAF SPRING FRONT EYE BUSHING



- 62-11401 62-67 2 per spring .....\$ 7.00 ea.



- 67-11401 68-74 .....\$ 16.00 ea.

## LEAF SPRING EYE BUSHING BOLTS



- Original style bolt kit.  
62-114021 62-67 8 pieces .....\$ 15.00 kit



- Original style bolt kit.  
67-114021 68-74 .....\$ 12.00 kit  
67-11402 68-74 replacement, bolt only ..\$ 3.75 ea.

## FRONT LEAF SPRING BRACKET MOUNTING KIT



- 67-11405 68-74 6 J-nuts only .....\$ 7.00 kit



- 6 J-nuts and 6 bolts.  
67-11406 68-74 .....\$ 14.00 kit

## LEAF SPRING & SHOCK MOUNTING PLATE



- 68-11409 68-69 LH or RH, with mono leaf .....\$ 44.00 ea.



- 67-114101 68-74 LH, with multi leaf .....\$ 33.00 ea.  
67-114102 68-74 RH, with multi leaf .....\$ 33.00 ea.

+ The following items require additional shipping and handling.



# CHEVROLET NOVA PARTS

Car Shop Inc. 739 North Batavia Orange, California 92868

## TRACTION BAR KIT

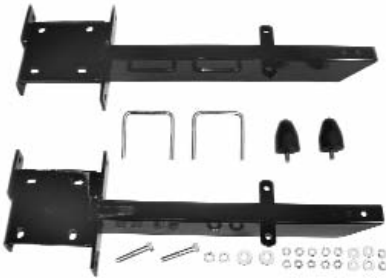

67-11413 68-74 .....\$ 224.00 kit

## LEAF SPRING PERCHES



Must be welded to the rear axle.

67-11425 68-74 with mono leaf springs  
LH & RH .....\$ 65.00 pr.



67-11426 68-74 with multi leaf springs  
LH & RH .....\$ 65.00 pr.

## REAR AXLE BUMPERS



62-11414 62-67 tall type .....\$ 8.00 ea.



62-11415 62-67 short type .....\$ 26.00 pr.



67-11414 68-74 replacement .....\$ 22.00 ea.

## REAR AXLE PINION BUMPER



67-11417 68-69 .....\$ 14.00 ea.

## DIFFERENTIAL COVER



67-11501 65-74 12-bolt, original design ..\$ 39.00 ea.



67-11502 64-74 10-bolt, chrome .....\$ 25.00 ea.

67-11503 65-74 12-bolt, chrome .....\$ 28.00 ea.

## HEAVY DUTY ALUMINUM DIFFERENTIAL COVER



PERFECT LAUNCH, reinforced lightweight aluminum rear end cover designed to strengthen the rear housing case in heavy torque situations.

67-115031 65-74 10-bolt .....\$ 169.00 ea.

67-115032 65-74 12-bolt .....\$ 169.00 ea.

## FINNED ALUMINUM DIFFERENTIAL COVER



67-115035 65-74 12-bolt .....\$ 119.00 ea.

## REAR AXLE DIFFERENTIAL HARDWARE



58-09418 62-63 Copper washers and nuts  
20 pcs. ....\$ 7.00 set

58-09417 62-63 Copper washers  
10 pcs. ....\$ 5.00 set

## REAR AXLE DIFFERENTIAL HARDWARE



58-09418 62-63 Bolts, lock washers  
and nuts, 30 pcs. ....\$ 9.00 set

## DIFFERENTIAL COVER GASKET



58-09319 62-63 Housing gasket .....\$ 6.00 ea.

67-11504 64-74 10-bolt .....\$ 6.00 ea.

67-11505 65-74 12-bolt .....\$ 7.00 ea.

## DIFFERENTIAL COVER BOLT KIT



64-115051 64-74 10 pieces .....\$ 10.00 set



67-115051 65-74 12 pieces .....\$ 12.00 set

## DIFFERENTIAL VENT



67-11508 62-74 .....\$ 4.00 ea.

## REAR END OVERHAUL KIT



67-115081 64-74 10 Bolt .....\$ 129.00 kit

67-115082 65-74 12 Bolt .....\$ 119.00 kit

# CHEVROLET NOVA PARTS



Car Shop Inc. 739 North Batavia Orange, California 92868

## REAR AXLE PINION SEAL



- |          |       |         |       |          |     |
|----------|-------|---------|-------|----------|-----|
| 67-11506 | 64-74 | 10-bolt | ..... | \$ 15.00 | ea. |
| 67-11507 | 65-74 | 12-bolt | ..... | \$ 12.00 | ea. |

## DIFFERENTIAL LUBRICANT TAG



Red plastic tag with white letters.

- |           |       |                     |       |         |     |
|-----------|-------|---------------------|-------|---------|-----|
| 67-11509  | 66-74 | use positraction... | ..... | \$ 9.00 | ea. |
| 67-115091 | 66-74 | use limited slip... | ..... | \$ 9.00 | ea. |

## DIFFERENTIAL LUBRICANT TAG



Metal style tag, Use limited slip diff. lube only.

- |           |       |       |       |         |     |
|-----------|-------|-------|-------|---------|-----|
| 67-115092 | 65-72 | ..... | ..... | \$ 6.00 | ea. |
|-----------|-------|-------|-------|---------|-----|

## DIFFERENTIAL FILL PLUG



- |           |       |            |       |         |     |
|-----------|-------|------------|-------|---------|-----|
| 58-093241 | 62-63 | Drain Plug | ..... | \$ 3.00 | ea. |
| 67-11510  | 64-74 | Magnetic   | ..... | \$ 5.00 | ea. |

Original style that accepts the red posi tag.

- |           |       |                  |       |          |     |
|-----------|-------|------------------|-------|----------|-----|
| 67-115101 | 64-74 | 3/4" Filler Plug | ..... | \$ 15.00 | ea. |
|-----------|-------|------------------|-------|----------|-----|

## UNIVERSAL JOINT U-BOLTS



- |           |       |                 |       |         |     |
|-----------|-------|-----------------|-------|---------|-----|
| 67-115118 | 62-72 | all, u-bolt kit | ..... | \$ 5.00 | pr. |
|-----------|-------|-----------------|-------|---------|-----|



- |           |       |                |       |         |     |
|-----------|-------|----------------|-------|---------|-----|
| 73-115117 | 73-79 | all, clamp kit | ..... | \$ 7.00 | pr. |
|-----------|-------|----------------|-------|---------|-----|

## UNIVERSAL JOINTS



- |           |       |                                      |      |          |     |
|-----------|-------|--------------------------------------|------|----------|-----|
| 67-115114 | 62-79 | front or rear<br>(outside snap ring) | .... | \$ 14.00 | ea. |
|-----------|-------|--------------------------------------|------|----------|-----|

## O.E. STYLE STEEL WHEELS



Fits small (1954-69 dog dish) hub caps, 5 lug, 5 on 4-3/4" bolt pattern. Hub caps & trim rings not included. **Made in U.S.A.**

- |           |          |                           |      |           |     |
|-----------|----------|---------------------------|------|-----------|-----|
| 67-11580+ | 14" x 6" | - 4" backside setting     | .... | \$ 99.00  | ea. |
| 67-11581+ | 14" x 7" | - 4 1/4" backside setting | ..   | \$ 99.00  | ea. |
| 67-11582+ | 15" x 7" | - 4 1/4" backside setting | ..   | \$ 104.00 | ea. |
| 67-11583+ | 15" x 8" | - 4 1/4" backside setting | ..   | \$ 105.00 | ea. |

## RALLY WHEELS



### SILVER

Hub caps & trim rings not included. **Made in U.S.A.**

- |           |          |                           |      |           |     |
|-----------|----------|---------------------------|------|-----------|-----|
| 67-11623+ | 14" x 6" | - 3-3/4" backside setting | ..   | \$ 94.00  | ea. |
| 67-11624+ | 14" x 7" | - 4" backside setting     | .... | \$ 95.00  | ea. |
| 67-11625+ | 15" x 4" | - 2-1/2" backside setting | ..   | \$ 116.00 | ea. |
| 67-11626+ | 15" x 6" | - 3-1/2" backside setting | ..   | \$ 99.00  | ea. |
| 67-11627+ | 15" x 7" | - 4-1/4" backside setting | ..   | \$ 99.00  | ea. |
| 67-11628+ | 15" x 8" | - 4-1/2" backside setting | ..   | \$ 104.00 | ea. |



### CHROME

- |           |          |                           |      |           |     |
|-----------|----------|---------------------------|------|-----------|-----|
| 67-11620+ | 14" x 7" | - 4" backside setting     | .... | \$ 142.00 | ea. |
| 67-11621+ | 15" x 7" | - 4-1/4" backside setting | ..   | \$ 149.00 | ea. |
| 67-11622+ | 15" x 8" | - 4-1/2" backside setting | ..   | \$ 150.00 | ea. |

## 1969-70 SS WHEEL



1969-70 Super Sport, silver/black.

Center caps & trim rings not included. **Made in U.S.A.**

- |           |          |       |       |           |     |
|-----------|----------|-------|-------|-----------|-----|
| 67-11590+ | 14" x 7" | ..... | ..... | \$ 169.00 | ea. |
| 67-11591+ | 15" x 7" | ..... | ..... | \$ 175.00 | ea. |

## RALLY WHEEL TRIM RINGS



### "REPRODUCTION" RALLY WHEEL TRIM RINGS

We now offer an affordable alternative to expensive GM trim rings.

- |          |          |               |       |          |     |
|----------|----------|---------------|-------|----------|-----|
| 67-11633 | 14" x 6" | .....         | ..... | \$ 29.00 | ea. |
| 67-11634 | 14" x 7" | .....         | ..... | \$ 36.00 | ea. |
| 67-11635 | 15" x 7" | squared edges | ..... | \$ 29.00 | ea. |
| 67-11636 | 15" x 7" | rounded edges | ..... | \$ 30.00 | ea. |
| 67-11637 | 15" x 8" | rounded edges | ..... | \$ 32.00 | ea. |

## "SS WHEEL" TRIM RINGS



Fits 1969-70 Super Sport 14 x 7 wheels.

- |          |       |          |       |          |     |
|----------|-------|----------|-------|----------|-----|
| 69-11702 | 69-70 | set of 4 | ..... | \$ 99.00 | set |
|----------|-------|----------|-------|----------|-----|

+ The following items require additional shipping and handling.

Fax Order 1-714-771-0407 • Toll Free 1-800-235-2470 • [www.TruckandCarShop.com](http://www.TruckandCarShop.com) • 2014 Catalog



# CHEVROLET NOVA PARTS

Car Shop Inc. 739 North Batavia Orange, California 92868

## HUB CAP SPINNER SETS



62-03207 62-63 set of 4, fits wire wheel . . \$ 189.00 set



62-032071 62-63 single, fits wire wheel . . \$ 59.00 ea.



65-03208 67 SS, set of 4 . . . . . \$ 315.00 set

65-03209 67 SS, single . . . . . \$ 89.00 ea.

## HUB CAP EMBLEMS



63-03115 63-64 "SS" . . . . . \$ 45.00 ea.



65-03213 65 "SS"  
67 "SS" . . . . . \$ 45.00 ea.



69-03217 71 fits finned wheel cover . . \$ 25.00 ea.

## "DOG DISH" HUB CAPS



67-117036 67 set of 4 . . . . . \$ 349.00 set



68-117036 68-69 set of 4 . . . . . \$ 349.00 set

**California Showroom hours:**  
**TUESDAY - FRIDAY: 8:30AM to 4:30PM**  
**SATURDAY: 8:30AM to 3:30PM**  
 (Showroom closed Sunday & Monday)  
**Phone order desk hours:**  
**MONDAY - FRIDAY: 8:30AM to 4:30PM**  
**ORDER TOLL FREE: 1-800-235-2470**  
**24 HOUR FAX: 714-771-0407**



## RALLY WHEEL HUB CAPS



Flat style with Bowtie logo, caps do not come painted, set of 4.

67-11704 polished stainless . . . . . \$ 140.00 set

67-11705 chrome . . . . . \$ 135.00 set



Original design, "Chevrolet Motor Division Disc Brake".

67-11707 67 chrome, set of 4 . . . . . \$ 145.00 set



Original design, "Chevrolet Motor Division".

67-11708 67 chrome, set of 4 . . . . . \$ 95.00 set





# CHEVROLET NOVA PARTS



Car Shop Inc. 739 North Batavia Orange, California 92868

## RALLY WHEEL HUB CAPS



Original design, "Chevrolet Motor Division"

68-11709 68-77 GM, single . . . . . \$ 249.00 ea.



68-11710 68-77 Reproduction, set of 4 . . \$ 185.00 set



68-11711 68-77 with Bow-Tie, set of 4 . . \$ 185.00 set

## PLASTIC RALLY WHEEL CENTER CAPS



Replacement Derby style caps, Chrome plastic, set of 4.

68-117101 68-77 . . . . . \$ 29.00 set

## RALLY WHEEL HUB CAP - CENTER CAP SCREWS



Center cap screw kit.

67-11714 67-77 4 original screws . . . . . \$ 6.00 kit

## RALLY WHEEL HUB CAP CENTER CAPS



Original design, "Chevrolet Motor Division"

67-117122 67 reproduction, single . . . \$ 19.00 ea.

67-117121 67 reproduction, 4 pcs. . . . \$ 72.00 set



Original design, "Chevrolet Motor Division Disc Brake"

67-11713 67 . . . . . \$ 23.00 ea.

## 1969-70 SS WHEEL CENTER CAPS



Chrome center cap with SS insert.

69-11716 69-70 reproduction . . . . . \$ 14.00 ea.

69-11715 69-70 Original GM . . . . . \$ 40.00 ea.



SS center cap retainer.

69-11718 69-70 reproduction . . . . . \$ 6.00 ea.

69-11717 69-70 Original GM . . . . . \$ 21.00 ea.

## 1969-70 SS WHEEL CENTER CAP INSERTS



SS insert only.

69-118071 69-70 repro set of 4 . . . . . \$ 16.00 set



SS 396 inserts only, set of 4, not original.

69-11808 69-70 set of 4, 1 3/4" . . . . . \$ 16.00 set



SS 454 inserts only, set of 4, not original.

69-11809 69-70 set of 4, 1 3/4" . . . . . \$ 16.00 set

## UNIVERSAL CENTER CAP INSERT DECALS



Blue & silver Bow-tie insert only

70-11807 1 9/16" . . . . . \$ 5.00 ea.



Universal center cap decals

67-11830 2" black with red Bowtie . . . . . \$ 5.00 ea.

67-11831 2" black with silver Chevrolet . . . \$ 5.00 ea.

## 1971-78 WHEEL CENTER CAPS



71-11845 71-78 . . . . . \$ 39.00 ea.

+ The following items require additional shipping and handling.

Fax Order 1-714-771-0407 • Toll Free 1-800-235-2470 • [www.TruckandCarShop.com](http://www.TruckandCarShop.com) • 2014 Catalog



# CHEVROLET NOVA PARTS

Car Shop Inc. 739 North Batavia Orange, California 92868

## VALVE STEM CAPS



67-11814 chrome .....\$ 5.00 set



67-11815 Skulls, chrome .....\$ 5.00 set



67-11816 Dice, chrome .....\$ 5.00 set



67-11817 Dice, black .....\$ 5.00 set

67-11818 Dice, white .....\$ 5.00 set

67-11819 Dice, red .....\$ 5.00 set

67-11820 Dice, green .....\$ 5.00 set

67-11821 Dice, purple .....\$ 5.00 set

67-11822 Dice, blue .....\$ 5.00 set



Original style valve stem caps.

67-118141 62-70 5 pcs. ....\$ 7.00 set

## LUG NUTS



67-11823 62-79 7/16" x 20 .....\$ .50 ea.

67-118231 62-79 7/16" x 20, set of 20 ...\$ 6.00 set



69-11824 69-70 SS lug nuts, stainless capped set of 20 .....\$ 35.00 set

## LUG STUDS



62-11825 62-79 7/16", knurled shank ...\$ 1.00 ea.

67-11825 62-79 1/2", knurled shank ...\$ 1.00 ea.

## WHEEL BEARINGS, FRONT



62-11901 62-63 Front inner bearing ...\$ 8.00 ea.

62-11902 62-63 Front outer bearing ...\$ 7.00 ea.

67-11901 64-78 Front inner bearing ...\$ 10.00 ea.

67-11902 64-79 Front outer bearing ...\$ 8.00 ea.

## WHEEL BEARING SEAL, FRONT



62-11903 62-63 Front bearing seal ....\$ 8.00 ea.

67-11903 64-74 Front bearing seal ....\$ 4.00 ea.

## WHEEL BEARINGS, REAR



62-11905 62-63 Rear bearing .....\$ 85.00 ea.

67-11905 64-79 Rear bearing .....\$ 17.00 ea.

## WHEEL BEARING SEAL, REAR



62-11906 62-63 Rear bearing seal ....\$ 10.00 ea.

67-11906 64-79 Rear bearing seal ....\$ 5.00 ea.

## FRONT WHEEL BEARING GREASE CAP



Correct button style reproduction grease caps.

67-119065 64-72 .....\$ 16.00 pr.



67-11907 64-72 replacement .....\$ 3.00 ea.

67-11908 64-72 GM replacement .....\$ 14.00 ea.

## SELF ADJUSTER REPAIR KITS



Front or rear, with drum brakes.

67-11910 64-79 LH .....\$ 15.00 kit

67-11911 64-79 RH .....\$ 15.00 kit

## BRAKE SHOE RETURN SPRING & HOLD DOWN KIT



With drum brakes.

67-11912 64-74 Front .....\$ 8.00 kit

67-11913 64-79 Rear .....\$ 7.00 kit

## BRAKE ADJUSTER HOLE COVER



67-11914 64-79 .....\$ 1.00 ea.

## BRAKE SHOE ANCHOR PIN



With drum brakes.

67-11917 64-74 Front .....\$ 18.00 ea.

67-119171 64-79 Rear .....\$ 22.00 pr.

## BRAKE PLATE TO SPINDLE HARDWARE



With drum brakes.

64-11850 64-72 Front, 8 pieces .....\$ 13.00 kit

# CHEVROLET NOVA PARTS



Car Shop Inc. 739 North Batavia Orange, California 92868

## PARKING BRAKE SHOE LEVERS



Parking brake shoe lever kit, with drum brakes.

- 67-11915 64-79 LH .....\$ 30.00 kit
- 67-11916 64-79 RH .....\$ 30.00 kit



Brake space bar, with drum brakes.

- 67-119162 64-79 LH or RH .....\$ 9.00 ea.



Brake shoe washer, with drum brakes.

- 67-119164 64-79 .....\$ 4.50 ea.

## EMERGENCY BRAKE LEVER SPRINGS



- 67-119168 67-79 .....\$ 3.00 pr.

## COMPLETE BRAKE HARDWARE KIT

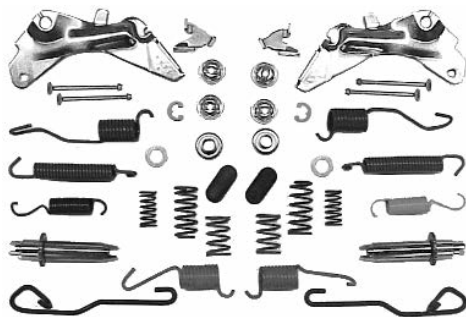

With drum brakes.

- 67-11918 64-74 Front .....\$ 38.00 kit
- 67-11919 64-79 Rear .....\$ 38.00 kit

## BRAKE HOSE TO CALIPER BOLT KIT



Fits single-piston calipers. 2 bolts & 4 copper seal washers.

- 69-11950 69-74 6 pieces .....\$ 11.00 ea.

## BRAKE HOSE COPPER SEAL WASHERS



Fits single-piston calipers. 2 bolts & 4 copper seal washers.

- 49-07823 62-74 .....\$ .50 ea.

## FRONT BRAKE HOSES



Two per car

- 62-12001 62-66 Drum .....\$ 15.00 ea.
- 67-12001 67 Drum .....\$ 18.00 ea.



- 67-12002 67-68 4-piston disc .....\$ 18.00 ea.
- 68-12003 68-74 Drum .....\$ 18.00 ea.



- 69-12004 69-74 Disc .....\$ 16.00 ea.

## REAR BRAKE HOSE



- 62-12009 62-66 .....\$ 15.00 ea.
- 67-12009 66-67 .....\$ 15.00 ea.
- 68-12010 68 .....\$ 22.00 ea.



- 69-12011 69-73 .....\$ 20.00 ea.
- 74-12012 74 .....\$ 18.00 ea.

## BRAKE LINE JUNCTION BLOCKS



1964-1967 Factory Drum and 1967 Disc

- 64-120135 64-67 front .....\$ 48.00 pr.



- 67-120135 62-68 rear .....\$ 17.00 ea.

## BRAKE HOSE RETAINER CLIP



- 67-12014 62-79 .....\$ 1.00 ea.

## FRONT BRAKE HOSE BRACKETS



These mount the drum brake hoses to the sub frame.

- 69-120143 69-74 front, 2 piece set .....\$ 26.00 pr.



These mount the disc brake hoses to the sub frame.

- 69-120141 69-74 front, 3 piece set .....\$ 42.00 set

## FRONT BRAKE HOSE BRACKET BOLTS



Also used to connect brake hose to A-arm on 1969 Camaros.

- 69-120145 69-74 front .....\$ 2.50 pr.

## REAR BRAKE HOSE TO DIFF BRACKETS



Fits 10 or 12 bolt rear ends.

- 67-120142 67-68 rear .....\$ 10.00 ea.



Fits 10 or 12 bolt rear ends.

- 69-120142 69 rear .....\$ 21.00 ea.

## BRAKE HOSE TO DIFF BRACKET BOLT



Mounts hose to rear axle bracket.

- 69-120146 69-74 rear .....\$ 2.00 ea.

## REAR BRAKE HOSE TO FLOOR BRACKET BOLTS



- 68-120148 68-72 rear .....\$ 3.00 pr.

+ The following items require additional shipping and handling.



# CHEVROLET NOVA PARTS

Car Shop Inc. 739 North Batavia Orange, California 92868

## BLEEDER SCREWS



Fits wheel cylinders, master cylinders & 4-piston calipers.

67-12015 64-74 5/16-24, 4 pieces . . . \$ 6.00 set

Fits single-piston calipers.

69-12015 69-74 3/8-24, 2 pieces . . . \$ 4.00 pr.



67-12016 62-74 Plastic dust caps . . . \$ 3.50 pr.

## BRAKE HOSE RETAINER CLIPS



These clips hold your front brake hose to your upper control arms.

69-120161 69-74 . . . \$ 14.00 pr.

## BRAKE LINE ARMOR SHIELD



10 foot roll

67-12017 62-79 3/16" . . . \$ 17.00 ea.

67-12018 62-79 1/4" . . . \$ 17.00 ea.

67-12019 62-79 5/16" . . . \$ 18.00 ea.

67-12020 62-79 3/8" . . . \$ 20.00 ea.

## WHEEL CYLINDER REPAIR KIT



67-12021 68-74 LH or RH, front . . . \$ 6.00 ea.

67-12022 64-74 LH or RH, rear . . . \$ 8.00 ea.

## WHEEL CYLINDERS



62-12023 62-63 LH, front . . . \$ 24.00 ea.

62-12024 62-63 RH, front . . . \$ 24.00 ea.



64-12023 64-67 LH, front . . . \$ 22.00 ea.

64-12024 64-67 RH, front . . . \$ 22.00 ea.

67-12023 68-74 LH, front . . . \$ 12.00 ea.

67-12024 68-74 RH, front . . . \$ 12.00 ea.



62-12025 62-63 LH, rear . . . \$ 26.00 ea.

62-120251 62-63 RH, rear . . . \$ 26.00 ea.



67-12025 64-74 LH or RH, rear . . . \$ 9.00 ea.

## WHEEL CYLINDER MOUNTING BOLTS



67-120265 64-74 . . . \$ 1.75 ea.

## WHEEL CYLINDER PUSH RODS



67-12027 62-74 LH or RH, replacement . \$ 2.00 ea.



67-120271 62-74 LH or RH, original . . . \$ 4.50 ea.

## MASTER CYLINDERS



64-09125 62-66 1-inch bore . . . \$ 59.00 ea.

66-09126 66 7/8-inch bore . . . \$ 92.00 ea.



With correct bail style top.

67-12028 67-74 With drum brakes . . . \$ 69.00 ea.



With bolt on style top, replacement style.

67-120281 67-74 With drum brakes . . . \$ 49.00 ea.



Tall design

67-12029 67-68 With disc . . . \$ 69.00 ea.



Short design

68-12030 67-69 With disc . . . \$ 65.00 ea.

# CHEVROLET NOVA PARTS



Car Shop Inc. 739 North Batavia Orange, California 92868

## MASTER CYLINDERS



Correct reproduction with original casting # & bleeder screws.  
68-12031 67-69 With disc . . . . . \$ 89.00 ea.



With disc, dual bail type, shallow push rod depth.  
70-12031 70-74 . . . . . \$ 45.00 ea.



Chrome plated aluminum master cylinder, dual bail cap.  
Ports on both sides.  
67-12040 67-74 1-inch bore . . . . . \$ 85.00 ea.  
67-12041 67-74 1 1/8-inch bore . . . . . \$ 85.00 ea.



Aluminum master cylinder, dual bail cap, ports on both sides.  
67-12042 67-74 1-inch bore . . . . . \$ 69.00 ea.  
67-12043 67-74 1 1/8-inch bore . . . . . \$ 69.00 ea.

## CHROME CUSTOM MASTER CYLINDERS



Chrome plated aluminum master cylinder with flat top lid. 1 inch bore.  
67-12044 67-74 ball milled top . . . . . \$ 129.00 ea.



67-120441 67-74 smooth top . . . . . \$ 129.00 ea.

## MASTER CYLINDER NUT KIT



67-12045 62-69 4 pieces . . . . . \$ 2.00 kit



70-12046 70-74 2 pieces . . . . . \$ 2.00 kit

## MASTER CYLINDER FIREWALL PLUG



Without power brakes.  
62-12050 62-67 . . . . . \$ 9.00 ea.

## MASTER CYLINDER GASKET



Master cylinder gasket without power brakes.  
67-12101 62-74 . . . . . \$ 5.00 ea.

## MASTER CYLINDER PUSH ROD TO PEDAL CLIP



67-121021 67-74 . . . . . \$ 3.00 ea.

## MASTER CYLINDER PUSH ROD KIT



67-12102 68-74 Push rod kit  
without power brakes . . . \$ 17.00 kit

## MASTER CYLINDER COVERS



Correct zinc-plated covers with seal. For cars with the original master cylinders, may not fit some aftermarket cylinders.

67-12103 67-69 With power disc brakes . \$ 17.00 ea.

70-12104 70-74 With power disc brakes  
single bail type . . . . . \$ 21.00 ea.

## CHROME MASTER CYLINDER COVER



67-12105 67-72 With disc, dual bail . . . \$ 7.00 ea.

67-12106 67-74 With drum, single bail . . \$ 7.00 ea.

## MASTER CYLINDER COVER SEAL



67-12107 67-72 With drum, single bail . . \$ 3.00 ea.

67-12108 67-64 With disc, dual bail . . . \$ 9.00 ea.



+ The following items require additional shipping and handling.



# CHEVROLET NOVA PARTS

Car Shop Inc. 739 North Batavia Orange, California 92868

## 4-PISTON BRAKE CALIPERS



- 67-12109 67-68 LH, 4-piston .....\$ 169.00 ea.  
 67-12110 67-68 RH, 4-piston .....\$ 169.00 ea.

## SINGLE PISTON BRAKE CALIPERS

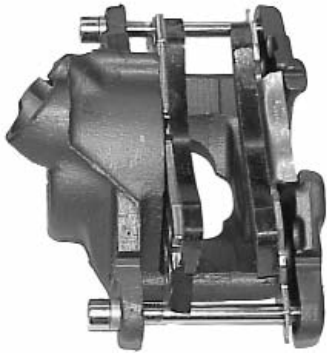

1969 original design.

- 69-12111 69 LH with pads .....\$ 79.00 ea.  
 69-12112 69 RH with pads .....\$ 79.00 ea.

1969 replacement.

- 69-12113 69-74 LH with pads .....\$ 49.00 ea.  
 69-12114 69-74 RH with pads .....\$ 49.00 ea.

## ALUMINUM DUAL PISTON BRAKE CALIPERS



Light weight aluminum D52 GM disc brake caliper. replaces stock single piston calipers, all new, loaded with semi metallic D52 pads.

- 69-12115 69-74 raw finish .....\$ 279.00 pr.  
 69-12116 69-74 polished .....\$ 369.00 pr.

## CALIPER MOUNTING BOLT



- 69-12119 69-74 .....\$ 8.00 pr.

## CALIPER MOUNTING HARDWARE KIT



- 69-12120 69-74 .....\$ 7.00 kit

## CALIPER MOUNTING BRACKET BOLT KITS



- 69-121212 68 for 4-piston calipers ....\$ 6.00 kit

## BRAKE CALIPER BRACKET & SHIELD BOLT KIT



- 69-121213 68 10-pieces .....\$ 25.00 kit  
 69-121214 69-74 10-pieces .....\$ 25.00 kit

## BRAKE CALIPER MOUNTING BRACKETS



Mounts single piston & D52 aluminum dual piston calipers

- 69-12121 69-74 .....\$ 69.00 pr

## SPINDLE BOLT



Correct style spindle bolt.

- 69-121215 68-74 .....\$ 5.00 ea.

## DISC BRAKE BACKING PLATES



Correct silver plating with stamped part numbers. RH & LH pair.  
 GM Part # 1381722 RH, 1381723 LH

- 67-12122 68 with 4-piston calipers ...\$ 64.00 pr.  
 1969-74 GM Part # 5463496 RH, 5463497 LH  
 69-12123 69-74 with single piston calipers \$ 64.00 pr.

For modular drop spindles.

- 68-121231 68-74 .....\$ 48.00 pr.

## BRAKE PADS



One set does two calipers.

- 67-12201 67-68 with 4-piston calipers ...\$ 32.00 set  
 69-12202 69-74 D52 type .....\$ 26.00 set

## BRAKE SHOES



- 62-12205 62-63 Front .....\$ 30.00 set  
 62-12206 62-63 Rear .....\$ 34.00 set  
 67-12205 64-74 Front .....\$ 34.00 set  
 67-12206 64-74 Rear .....\$ 30.00 set

## BRAKE DRUM BACKING PLATES



Includes brake shoe mounting stud.

- 67-122102 68-74 LH, rear .....\$ 55.00 ea.  
 67-122103 68-74 RH, rear .....\$ 55.00 ea.

# CHEVROLET NOVA PARTS



Car Shop Inc. 739 North Batavia Orange, California 92868

## BRAKE DRUMS



67-12207 64-68 Front, non-finned . . . . \$ 35.00 ea.



67-12208 64-74 Front, finned . . . . \$ 35.00 ea.  
67-12209 64-74 Rear . . . . \$ 35.00 ea.

## REAR DRUM BRAKE ASSEMBLIES



67-122104 68-74 LH & RH, rear . . . . \$ 379.00 pr.

## REAR AXLE RETAINER PLATE BOLT KIT



67-122108 64-74 24 pieces . . . . \$ 11.00 kit

## DISC BRAKE SPINDLES



Stock replacements.

67-12218 68-74 . . . . \$ 79.00 ea.

## MODULAR DISC BRAKE SPINDLES



2 inch drop spindles, for factory 1969-74 single piston brakes.

62-122182 62-67 . . . . \$ 225.00 pr.

2 inch drop spindles, for factory brakes.

67-122182 68-74 . . . . \$ 225.00 pr.

## C5 DISC BRAKE SPINDLES



These spindles are a direct bolt on. This spindle utilizes a C5 bearing hub assembly. They also utilize C5 brakes or aftermarket alternatives (a direct fit for Baer, Brembo, and Wilwood C5 applications). Maintains the stock drum brake offset.

67-122185 68-74 . . . . \$ 269.00 pr.

## BRAKE ROTORS



67-12211 67-68 4-piston . . . . \$ 109.00 ea.  
69-12212 69-74 . . . . \$ 45.00 ea.



69-12217 69-74 X-Drilled & Slotted . . . \$ 149.00 pr.

## SPINDLE NUT & WASHER SET

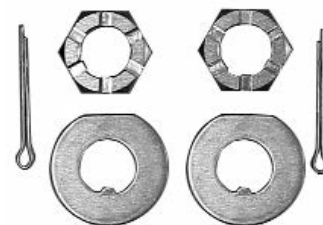

67-122201 64-79 . . . . \$ 10.00 set



\* The following items require additional shipping and handling.

Fax Order 1-714-771-0407 • Toll Free 1-800-235-2470 • [www.TruckandCarShop.com](http://www.TruckandCarShop.com) • 2014 Catalog



# CHEVROLET NOVA PARTS

Car Shop Inc. 739 North Batavia Orange, California 92868

## POWER BRAKE MANIFOLD T-FITTINGS



Connects brake booster vacuum hose/tube to the intake manifold.  
**67-12301** 64-72 1 port, 3/8" .....\$ 15.00 ea.



**67-12302** 64-72 2 port, 3/8" & 1/4" .....\$ 16.00 ea.



**67-12303** 64-72 Threaded port .....\$ 15.00 ea.



**67-12304** 64-72 2 port, threaded & 1/4" .....\$ 15.00 ea.



**67-12305** 64-72 3 port,  
 (1) threaded & (2) 1/4" .....\$ 16.00 ea.



**73-12306** 73-78 4 port,  
 (1) threaded & (3) 1/4" .....\$ 25.00 ea.

## VACUUM BOOSTER PIPE



Replacement for some years.  
**67-012307** 67-72 S/B .....\$ 19.00 ea.



**67-12308** 68-69 B/B .....\$ 33.00 ea.

## VACUUM BOOSTER PIPE



**70-12309** 70 B/B .....\$ 28.00 ea.  
**71-12310** 71-72 B/B .....\$ 28.00 ea.

## POWER BRAKE BOOSTER



*Gold cadmium plated*  
**62-12311** 62-67 9" .....\$ 149.00 ea.



Exact reproduction, features "Delco Moraine" logo  
**67-12311** 68-74 11" .....\$ 169.00 ea.



*Chrome booster*  
**62-123112** 62-67 9" .....\$ 249.00 ea.  
**67-123112** 68-74 11" .....\$ 259.00 ea.

## POWER BRAKE BOOSTER DUST BOOT



**67-12313** 68-74 White plastic .....\$ 11.00 ea.

## BRAKE BOOSTER TO FIREWALL NUT KIT



**67-123131** 62-69 8 pieces .....\$ 3.50 kit



**70-123131** 70-74 4 pieces .....\$ 3.50 kit

## BRAKE BOOSTER HOSE AND VALVE KIT



**67-12314** 68-74 S/B .....\$ 20.00 kit  
**67-12315** 68-72 B/B .....\$ 18.00 kit

## POWER BOOSTER HOSE BRACKET



**67-12316** 68-72 .....\$ 13.00 ea.

## POWER BRAKE BOOSTER CHECK VALVE



**67-12317** 64-79 Original color, with seal .....\$ 10.00 ea.



**67-123171** 64-79 Chrome, without seal .....\$ 8.00 ea.

## MASTER CYLINDER PUSH ROD



For power brakes, fits in booster.  
**67-12318** 68-74 Long .....\$ 5.00 ea.  
**71-12319** 68-74 Short .....\$ 5.00 ea.



# CHEVROLET NOVA PARTS



Car Shop Inc. 739 North Batavia Orange, California 92868

## C5 FRONT DISC BRAKE CONVERSION KITS



### C5 spindle & disc brake kit.

These spindles are a direct bolt on. This spindle utilizes a C5 bearing hub assembly. Complete brake kits include spindles, slotted and drilled rotors, loaded calipers, stainless steel braided brake hoses, C5 bearing hub assembly and mounting hardware. Specify black or red calipers.  
Note: C5 hubs use 12x1.5 metric lug nuts.

Maintains the stock drum brake offset.

- 67-12330+ 68-74 LH & RH, black ..... \$ 649.00 kit
- 67-12331+ 68-74 LH & RH, red ..... \$ 649.00 kit

## STOCK FRONT DISC BRAKE CONVERSION KITS



### Single piston front disc brake kit.

Includes: Calipers, Caliper mounting brackets, Rotors, Backing Plates, Brake Pads, Spindles, Wheel Bearings, Seals, Grease Caps & Hoses.

- 67-12401+ 68-74 LH & RH ..... \$ 399.00 pr.

## POWER FRONT DISC BRAKE CONVERSION KITS



### Power single piston front disc brake kit.

Includes: Calipers, caliper brackets, rotors, cad plated power booster, master cylinder, proportioning valve, master cylinder line kit, new front brake line kit, brake pads, wheel bearings, hoses & hardware.

Works with most 15" wheels

1962-67 Nova kits come with 9" booster

1962-63 models require 5-lug drum spindles and steering arms.

- 62-12340+ 62-64 5 lug ..... \$ 699.00 kit
- 65-12341+ 65-66 5 lug ..... \$ 699.00 kit
- 67-12342+ 67 5 lug ..... \$ 699.00 kit

## POWER FRONT DISC BRAKE CONVERSION KITS



### With cross drilled & slotted rotors.

- 62-12344+ 62-64 5 lug ..... \$ 799.00 kit
- 65-12345+ 65-66 5 lug ..... \$ 799.00 kit
- 67-123461+ 67 5 lug ..... \$ 799.00 kit

### With cross drilled & slotted rotors & red calipers.

- 62-12347+ 62-64 5 lug ..... \$ 859.00 kit
- 65-12348+ 65-66 5 lug ..... \$ 859.00 kit
- 67-12349+ 67 5 lug ..... \$ 859.00 kit

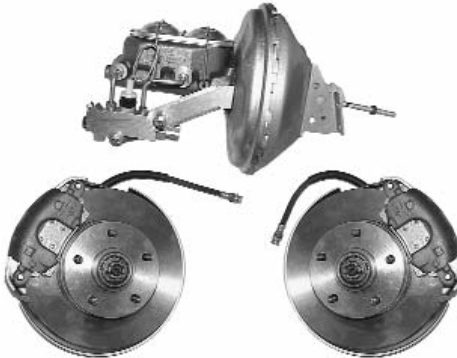

### Power single piston front disc brake kit.

Includes: Calipers, Master Cylinder, Rotors, Cad Plated Power Booster Backing plates, Brake Pads, Spindles, Wheel Bearings, Hoses, Attachment Hardware, Proportioning Valve, Master Cylinder Line Kit

1968-74 Nova kits come with 11" booster

Works with most 15" wheels

- 67-12402+ 68-74 ..... \$ 699.00 kit



### With cross drilled & slotted rotors.

- 67-12350+ 68-74 ..... \$ 799.00 kit

### With cross drilled & slotted rotors & red calipers.

- 67-12351+ 68-74 ..... \$ 859.00 kit

## 2 INCH DROP SPINDLE POWER FRONT DISC BRAKE KIT

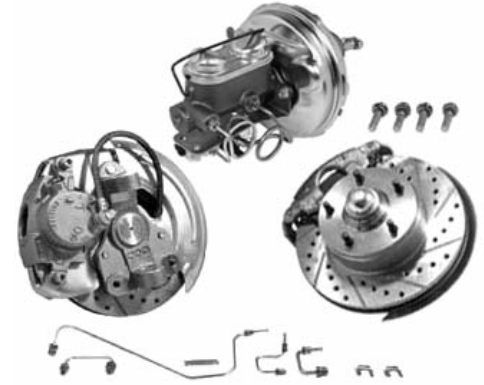

Improve your cars braking performance, add power brakes and lower it 2 inches, all in one kit. This kit works with most 15" and larger wheels. The drop spindle comes assembled with 11" rotors and loaded calipers, bearings, seals, dust caps, spindle nuts, banjo bolts and brake hoses, plus an assembled power brake booster with a disc brake master cylinder, proportioning valve and an original material conversion brake line kit.

- 62-12223+ 62-64 ..... \$ 799.00 kit
- 65-12223+ 65-66 ..... \$ 799.00 kit
- 67-12223+ 67 ..... \$ 799.00 kit
- 68-12223+ 68-74 ..... \$ 799.00 kit

### With cross drilled & slotted rotors.

- 62-122231+ 62-64 ..... \$ 899.00 kit
- 65-122231+ 65-66 ..... \$ 899.00 kit
- 67-122231+ 67 ..... \$ 899.00 kit
- 68-122231+ 68-74 ..... \$ 899.00 kit

### With cross drilled & slotted rotors & red calipers.

- 62-122232+ 62-64 ..... \$ 959.00 kit
- 65-122232+ 65-66 ..... \$ 959.00 kit
- 67-122232+ 67 ..... \$ 959.00 kit
- 68-122232+ 68-74 ..... \$ 959.00 kit



+ The following items require additional shipping and handling.



# CHEVROLET NOVA PARTS

Car Shop Inc. 739 North Batavia Orange, California 92868

## 13" FRONT DISC BRAKE CONVERSION KITS

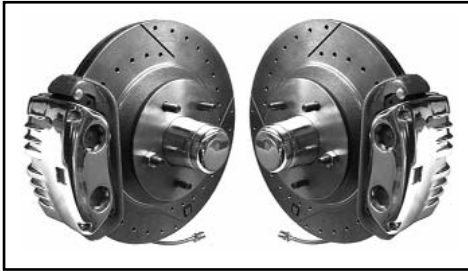

### 13" dual piston front disc brake kit, stock height

Includes: 13" cross drilled and gas slotted rotors, dual 38mm piston aluminum calipers, stock height spindles, high performance brake pads, bearings, seals, steel hubs, rubber brake hoses, grease caps, spindle nuts, mounting brackets and all necessary hardware.

Must use 17" rims or larger.

67-124071+ 68-74 stock height . . . . . \$ 849.00 kit

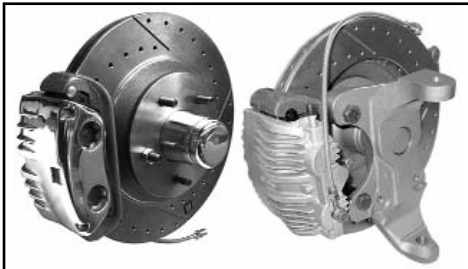

### 13" dual piston front disc brake kit, 2" drop

Includes: 13" cross drilled and gas slotted rotors, dual 38mm piston aluminum calipers, 2" Drop spindles, high performance brake pads, bearings, seals, steel hubs, rubber brake hoses, grease caps, spindle nuts, mounting brackets and all necessary hardware.

Must use 17" rims or larger.

67-124072+ 68-74 2-inch drop, 13" . . . . . \$ 849.00 kit

## HYDRAULIC ASSIST POWER BRAKE FRONT DISC BRAKE CONVERSION KIT

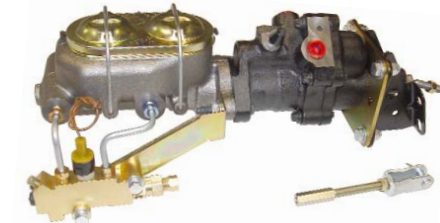

Includes: Calipers, Caliper mounting brackets, Rotors, Backing plates, Brake Pads, Spindles, Wheel Bearings & Seals, Hoses, Power steering hoses & modification parts, Hydro Boost unit & Master Cylinder, Proportioning Valve optional.

67-12403+ 68-74 Without prop valve . . . . \$ 959.00 kit

67-12404+ 68-74 With prop valve . . . . . \$ 989.00 kit

## HYDRAULIC ASSIST POWER BRAKE MASTER CYLINDER COMBO

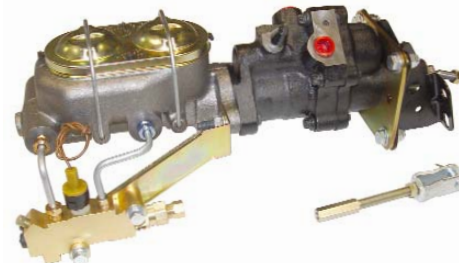

Receives hydraulic pressure from your power steering pump, Includes power steering hose modification kit.

67-12406 68-74 with front disc prop valve . . . . . \$ 599.00 kit

With chrome lid and chrome prop valve kit.

67-124064 68-74 with front disc prop valve . . . . . \$ 675.00 kit



## HYDRAULIC ASSIST POWER BRAKE HOSE KIT



67-12407 68-74 hose kit, rubber . . . . . \$ 229.00 kit



67-124073 68-74 hose kit, steel braided . . \$ 279.00 kit

## POWER BRAKE BOOSTER, MASTER CYLINDER & PROP. VALVE COMBO



With Gold cadmium plated booster

62-12408 62-67 with drum . . . . . \$ 299.00 kit

62-124081 62-67 with front disc . . . . . \$ 299.00 kit

### Custom high mount kit

Mounts booster 1 5/8" higher than stock location. Works with after market Mustang 2 front ends that no longer use factory shock towers.

62-124082 62-67 with front disc . . . . . \$ 329.00 kit



With Gold cadmium plated booster

67-12408 68-74 with front disc . . . . . \$ 299.00 kit

With Chrome plated booster

67-124081 68-74 with front disc . . . . . \$ 399.00 kit

With Chrome plated booster, master cylinder & prop valve.

67-124082 68-74 with front disc . . . . . \$ 429.00 kit

+ The following items require additional shipping and handling.

# CHEVROLET NOVA PARTS



Car Shop Inc. 739 North Batavia Orange, California 92868

## POWER BRAKE BOOSTER, MASTER CYLINDER & PROP. VALVE COMBO



This is the booster kit for the concours restorer looking to duplicate the factory correct booster assembly. Correct master cylinder with bleeder screws, round proportioning valve with correct metering block.

67-124083 68-69 front disc ..... \$ 329.00 kit

## DISC BRAKE PROPORTIONING VALVE



Modern replacement type.

67-12409 62-79 front disc ..... \$ 59.00 ea.

67-12410 62-79 4-wheel disc ..... \$ 59.00 ea.

## DISC BRAKE PROPORTIONING VALVE KIT



Complete kit: universal proportioning valve, master cylinder lines & mounting bracket, for use with 1967-69 style master cylinder.

Mounts the valve under the master cylinder.

47-094153 62-67 with front disc ..... \$ 89.00 kit

47-094158 62-67 with 4-wheel disc ..... \$ 89.00 kit

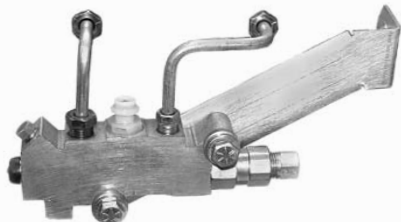

Complete kit: universal proportioning valve, master cylinder lines & mounting bracket, for use with 1967-69 style master cylinder.

Mounts the valve on the left side of the master cylinder.

67-124092 68-73 with front disc ..... \$ 79.00 kit

67-124093 68-73 with 4-wheel disc ..... \$ 79.00 kit

## BRAKE MASTER CYLINDER & PROP VALVE KIT



With cast iron master cylinder.

62-12430 62-67 with front disc ..... \$ 149.00 kit

62-12431 62-67 with 4-wheel disc ..... \$ 149.00 kit



With cast iron master cylinder, 1 inch bore.

68-12430 68-74 with front disc ..... \$ 139.00 kit

68-12431 68-74 with 4-wheel disc ..... \$ 139.00 kit

With cast iron master cylinder, 1 1/8 inch bore.

68-12432 68-74 with front disc ..... \$ 139.00 kit

68-12433 68-74 with 4-wheel disc ..... \$ 139.00 kit



With aluminum master cylinder, 1 inch bore.

68-12434 68-74 with front disc ..... \$ 169.00 kit

68-12435 68-74 with 4-wheel disc ..... \$ 169.00 kit

With aluminum master cylinder, 1 1/8 inch bore.

68-12436 68-74 with front disc ..... \$ 169.00 kit

68-12437 68-74 with 4-wheel disc ..... \$ 169.00 kit

## BRAKE MASTER CYLINDER & PROP VALVE KIT



Includes chrome master cylinder, chrome proportioning valve, master cylinder lines & chrome mounting bracket.

All chrome, 1 inch bore.

68-12438 68-74 with front disc ..... \$ 199.00 kit

68-12439 68-74 with 4-wheel disc ..... \$ 199.00 kit

All chrome, 1 1/8 inch bore.

68-12440 68-74 with front disc ..... \$ 199.00 kit

68-12441 68-74 with 4-wheel disc ..... \$ 199.00 kit

## DISC BRAKE PROPORTIONING HOLD OFF VALVE



Original style new replacements, round valve with bracket

67-12413 67-68 ..... \$ 85.00 ea.

68-12413 69 ..... \$ 85.00 ea.



70-12413 70 ..... \$ 85.00 ea.

## PROPORTIONING VALVE BRACKET, ORIGINAL DESIGN



Mounts original design valves.

67-12414 67-68 ..... \$ 27.00 ea.

69-12414 69-70 ..... \$ 12.00 ea.



71-12414 71-74 ..... \$ 19.00 ea.

† The following items require additional shipping and handling.

Fax Order 1-714-771-0407 • Toll Free 1-800-235-2470 • [www.TruckandCarShop.com](http://www.TruckandCarShop.com) • 2014 Catalog



# CHEVROLET NOVA PARTS

Car Shop Inc. 739 North Batavia Orange, California 92868

## BRAKE VALVE & SWITCH BOLT KIT



71-124142 71-72 with power brakes . . . . \$ 3.00 kit

## PROPORTIONING VALVE, ORIGINAL DESIGN



67-124151 67-69 all . . . . . \$ 69.00 ea.  
70-124151 70-74 all . . . . . \$ 89.00 ea.

## ADJUSTABLE PROPORTIONING VALVE



67-12415 . . . . . \$ 59.00 ea.

## REAR BRAKE HOLD OFF VALVE



67-12420 68-69 . . . . . \$ 44.00 ea.  
70-12420 70 . . . . . \$ 44.00 ea.

## REAR DISC BRAKE KITS

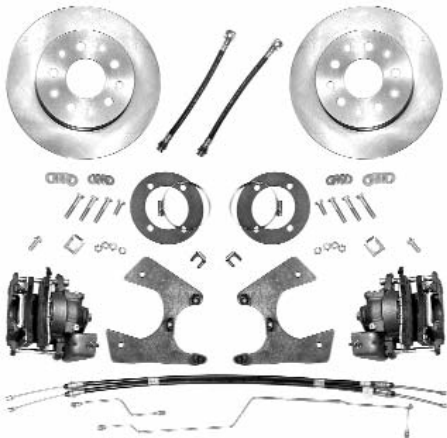

Includes custom rear E-brake cables & hard lines  
Fits 10 or 12 bolt rear ends.

68-12501+ 68-74 . . . . . \$ 599.00 kit  
68-125011+ 68-74 with 12" rotors . . . . \$ 699.00 kit

## PARKING BRAKE RELEASE HANDLE



Will fit 1962-1967.

62-12502 62-65 Made in USA . . . . . \$ 34.00 ea.  
62-125021 62-65 import . . . . . \$ 22.00 ea.



66-12502 66-67 . . . . . \$ 34.00 ea.



67-12502 68-79 black . . . . . \$ 5.00 ea.



67-125021 68-79 Chrome . . . . . \$ 6.00 ea.



67-12503 68-74 Handle rod grommet . . \$ 4.00 ea.

## PARKING BRAKE LIGHT SWITCH



67-125032 68-74 . . . . . \$ 18.00 ea.

## PARKING BRAKE SWITCH PADDLE CLIP



The clip attaches to the parking brake pedal assembly where the emergency brake cable clips to, and deactivates the parking light switch when it is not applied (up).

67-125033 68-74 . . . . . \$ 13.00 ea.

## PARKING BRAKE CABLE RETAINER CLIP



This commonly missing clip keeps the emergency brake cable from falling out of the bracket.

67-125034 68-74 . . . . . \$ 5.50 ea.

## PARKING BRAKE ROD CATCH PAWL & SPRING



62-12506 62-67 . . . . . \$ 22.00 kit

## PARKING BRAKE HANDLE ASSEMBLY



66-12504 66-67 . . . . . \$ 99.00 ea.

## PARKING BRAKE PEDAL ASSEMBLY



67-12504 68 . . . . . \$ 70.00 ea.  
69-12505 69 . . . . . \$ 70.00 ea.

## PARKING BRAKE TO DASH HARDWARE KIT



62-125041 62-65 1 piece . . . . . \$ 2.00 ea.



66-125041 66-67 . . . . . \$ 3.50 pr.



67-125041 68-72 3 pieces . . . . . \$ 3.00 kit

## PARKING BRAKE CABLE & BRACKET HARDWARE KIT



62-125141 62-67 9 pieces . . . . . \$ 6.00 kit

+ The following items require additional shipping and handling.

# CHEVROLET NOVA PARTS



Car Shop Inc. 739 North Batavia Orange, California 92868

## PARKING BRAKE CABLES

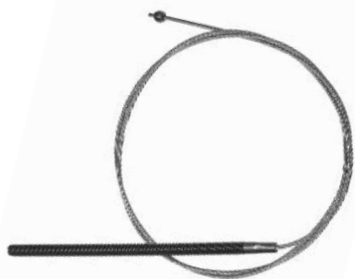

### FRONT

- 67-12508 68-71 plastic coated .....\$ 29.00 ea.  
67-125081 68-71 OE spiral wound .....\$ 47.00 ea.



### INTERMEDIATE

- 68-12511 68-74 Intermediate, 83 7/8" ...\$ 13.00 ea.

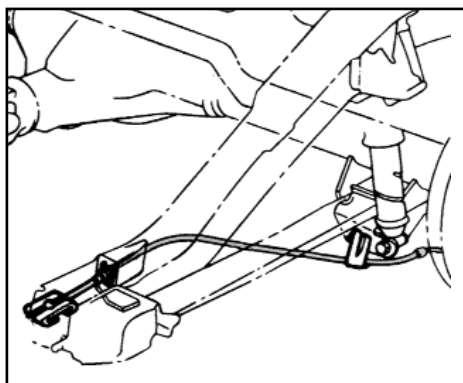

### REAR

- 67-12512 68-75 plastic coated  
LH or RH .....\$ 24.00 ea.



- 67-125121 68-75 OE spiral wound  
LH or RH .....\$ 39.00 ea.

## PARKING BRAKE CABLE CLIPS



- 67-12514 62-79 3 pcs. ....\$ 5.00 set

## PARKING BRAKE CABLE CONNECTORS



Front cable to intermediate cable connector.

- 67-12515 68-74 Front .....\$ 6.50 ea.



Intermediate cable guide hook.

- 67-12516 68-74 Cable guide .....\$ 8.00 ea.



Intermediate cable to rear cable connectors.

- 67-12517 62-79 Rear .....\$ 4.00 ea.



### Parking brake cable connector kit

Front cable connector, cable guide hook and 2 rear connectors.

- 67-125172 68-74 4 piece kit .....\$ 14.00 kit

## PARKING BRAKE CABLE SUPPORTS



Mounts to multi leaf shock mount plate.

- 68-12518 68-74 .....\$ 25.00 pr.

## BRASS UNION



3/8-24 Female thread both sides, 3/16" tube.

- 67-12530 3/8-24 .....\$ 4.00 ea.

7/16-24 Female thread both sides, 1/4" tube.

- 67-12531 7/16-24 .....\$ 4.00 ea.

1/2-20 Female thread both sides, 5/16" tube.

- 67-12532 1/2-20 .....\$ 4.00 ea.

5/8-18 Female thread both sides, 3/8" tube.

- 67-12533 5/8-18 .....\$ 4.00 ea.

## INVERTED FLARE PLUG



- 67-12535 3/8-24 thread .....\$ 3.50 ea.

- 67-12536 7/16-24 thread .....\$ 3.50 ea.

## FRONT BRAKE LINE KITS



### ORIGINAL MATERIAL

- 62-12601+ 62-64 Standard drum,  
4 line set .....\$ 50.00 kit  
65-12601+ 65-66 Standard drum,  
4 line set .....\$ 50.00 kit  
67-12600+ 67 Standard drum,  
4 line set .....\$ 59.00 kit  
67-12601+ 68 Standard drum,  
4 line set .....\$ 54.00 kit  
67-12602+ 68 Power drum,  
4 line set .....\$ 54.00 kit  
67-12603+ 68 Standard disc,  
5 line set .....\$ 54.00 kit  
67-12604+ 68 Power disc,  
5 line set .....\$ 54.00 kit

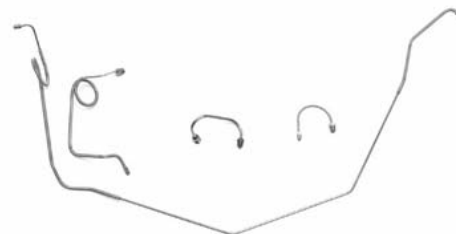

- 69-12604+ 69-73 Standard drum,  
4 line set .....\$ 54.00 kit  
69-12606+ 69-73 Power drum,  
4 line set .....\$ 54.00 kit  
69-12608+ 69 Power disc,  
4 line set .....\$ 54.00 kit  
70-12609+ 70 Power disc,  
7 line set .....\$ 74.00 kit  
71-12610+ 71-72 Power disc,  
4 line set .....\$ 60.00 kit

### STAINLESS STEEL

- 62-12611+ 62-64 Standard drum,  
4 line set .....\$ 70.00 kit  
65-12611+ 65-66 Standard drum,  
4 line set .....\$ 70.00 kit  
67-12611+ 67 Standard drum,  
4 line set .....\$ 84.00 kit  
67-12613+ 68 Standard drum,  
4 line set .....\$ 84.00 kit  
67-12614+ 68 Power drum,  
4 line set .....\$ 84.00 kit  
67-12615+ 68 Standard disc,  
5 line set .....\$ 84.00 kit  
67-12616+ 68 Power disc,  
5 line set .....\$ 84.00 kit  
69-12616+ 69-73 Standard drum,  
4 line set .....\$ 84.00 kit  
69-12618+ 69-73 Power drum,  
4 line set .....\$ 84.00 kit  
69-12620+ 69 Power disc,  
4 line set .....\$ 84.00 kit  
70-12621+ 70 Power disc,  
7 line set .....\$ 94.00 kit  
71-12622+ 71-72 Power disc,  
4 line set .....\$ 84.00 kit

+ The following items require additional shipping and handling.

Fax Order 1-714-771-0407 • Toll Free 1-800-235-2470 • [www.TruckandCarShop.com](http://www.TruckandCarShop.com) • 2014 Catalog



# CHEVROLET NOVA PARTS

Car Shop Inc. 739 North Batavia Orange, California 92868

## FRONT CALIPER BRAKE LINES



### ORIGINAL MATERIAL

|           |       |                        |                |
|-----------|-------|------------------------|----------------|
| 67-12625  | 67-68 | LH, 3/8" & 3/8" ports  | ..\$ 10.00 ea. |
| 67-126251 | 67-68 | LH, 3/8" & 1/2" ports  | ..\$ 10.00 ea. |
| 67-12626  | 67-68 | RH, 3/8" & 3/8" ports  | ..\$ 10.00 ea. |
| 67-126261 | 67-68 | RH, 3/8" & 7/16" ports | ..\$ 10.00 ea. |

### STAINLESS STEEL

|           |       |                        |                |
|-----------|-------|------------------------|----------------|
| 67-12627  | 67-68 | LH, 3/8" & 3/8" ports  | ..\$ 12.00 ea. |
| 67-126271 | 67-68 | LH, 3/8" & 1/2" ports  | ..\$ 12.00 ea. |
| 67-12628  | 67-68 | RH, 3/8" & 3/8" ports  | ..\$ 12.00 ea. |
| 67-126281 | 67-68 | RH, 3/8" & 7/16" ports | ..\$ 12.00 ea. |

## FRONT TO REAR BRAKE LINES

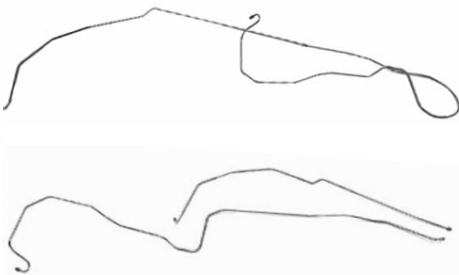

### ORIGINAL MATERIAL

|           |       |                     |                   |
|-----------|-------|---------------------|-------------------|
| 62-12630+ | 62-65 | all                 | .....\$ 48.00 ea. |
| 66-12630+ | 66    | with dual exhaust   | ....\$ 48.00 ea.  |
| 66-12631+ | 66    | with single exhaust | ....\$ 48.00 ea.  |
| 67-12630+ | 67    | all                 | .....\$ 48.00 ea. |
| 68-12630+ | 68    | all                 | .....\$ 48.00 ea. |
| 69-12630+ | 69    | Manual brakes       | .....\$ 59.00 ea. |
| 69-12631+ | 69    | Power brakes        | .....\$ 59.00 ea. |
| 70-12630+ | 70    | Power disc, 1-piece | ....\$ 60.00 ea.  |
| 71-12630+ | 71-73 | Power disc, 1-piece | ....\$ 60.00 ea.  |
| 71-12631+ | 71-73 | Manual drum         | .....\$ 60.00 ea. |

### STAINLESS STEEL

|           |       |                     |                   |
|-----------|-------|---------------------|-------------------|
| 62-12640+ | 62-65 | all                 | .....\$ 64.00 ea. |
| 66-12640+ | 66    | with dual exhaust   | ....\$ 64.00 ea.  |
| 66-12640+ | 66    | with single exhaust | ....\$ 64.00 ea.  |
| 67-12640+ | 67    | all                 | .....\$ 64.00 ea. |
| 68-12640+ | 68    | all                 | .....\$ 64.00 ea. |
| 69-12640+ | 69    | Manual brakes       | .....\$ 74.00 ea. |
| 69-12641+ | 69    | Power brakes        | .....\$ 74.00 ea. |
| 70-12640+ | 70    | Power disc, 1-piece | ....\$ 74.00 ea.  |
| 71-12640+ | 71-73 | Power disc, 1-piece | ....\$ 74.00 ea.  |
| 71-12641+ | 71-73 | Manual drum         | .....\$ 74.00 ea. |

## REAR AXLE BRAKE LINE SETS

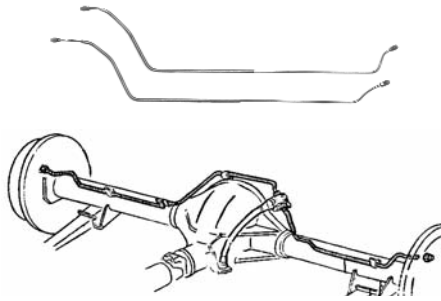

### ORIGINAL MATERIAL

|          |       |                 |                   |
|----------|-------|-----------------|-------------------|
| 62-12651 | 62-65 | 6-cyl           | .....\$ 27.00 pr. |
| 66-12651 | 66-67 | all             | .....\$ 27.00 pr. |
| 68-12652 | 68    | With mono leaf  | .....\$ 24.00 pr. |
| 68-12653 | 68    | With multi leaf | .....\$ 24.00 pr. |
| 69-12654 | 69-73 | all             | .....\$ 24.00 pr. |

### STAINLESS STEEL

|          |       |                 |                   |
|----------|-------|-----------------|-------------------|
| 62-12659 | 62-65 | 6-cyl           | .....\$ 35.00 pr. |
| 66-12659 | 66-67 | all             | .....\$ 35.00 pr. |
| 68-12660 | 68    | With mono leaf  | .....\$ 34.00 pr. |
| 68-12661 | 68    | With multi leaf | .....\$ 34.00 pr. |
| 69-12662 | 69-73 | all             | .....\$ 34.00 pr. |

## DISC BRAKE CONVERSION LINE SET

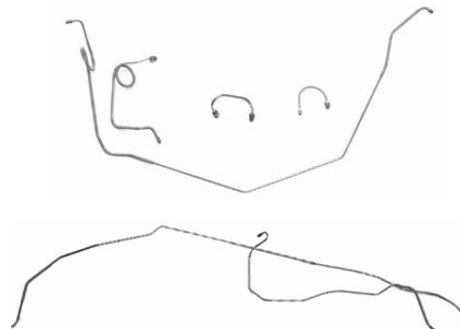

All lines are pre-bent and have the correct fittings to mate-to our replacement proportioning valves.

### ORIGINAL MATERIAL

|  |       |                |                   |
|--|-------|----------------|-------------------|
| Dual master & power disc brake conversion line kit.<br>For use with valve kit that mounts the under the master cylinder. |       |                |                   |
| 62-12665+  | 62-64 | front line kit | .....\$ 84.00 set |
| 65-12665+  | 65-66 | front line kit | .....\$ 84.00 set |

Power disc brake conversion line kit.  
For use with valve kit that mounts to the left side of the master cylinder.

|   |       |                |                    |
|---|-------|----------------|--------------------|
| 67-12665+   | 67    | front line kit | .....\$ 70.00 set  |
| 1968-1973 kit includes front line kit and 2-piece front to rear line. |       |                |                    |
| 68-12665+   | 68-73 |                | .....\$ 114.00 set |

### STAINLESS STEEL

|  |       |                |                   |
|--|-------|----------------|-------------------|
| Dual master & power disc brake conversion line kit.<br>For use with valve kit that mounts the under the master cylinder. |       |                |                   |
| 62-12666+  | 62-64 | front line kit | .....\$ 99.00 set |
| 65-12666+  | 65-66 | front line kit | .....\$ 99.00 set |

Power disc brake conversion line kit.  
For use with valve kit that mounts to the left side of the master cylinder.

|   |       |                |                    |
|---|-------|----------------|--------------------|
| 67-12666+   | 67    | front line kit | .....\$ 89.00 set  |
| 1968-1973 kit includes front line kit and 2-piece front to rear line. |       |                |                    |
| 68-12666+   | 68-73 |                | .....\$ 159.00 set |

## BRAKE LINE CLIPS



|          |       |           |                   |
|----------|-------|-----------|-------------------|
| 64-12701 | 64-65 | 8 pieces  | .....\$ 21.00 set |
| 66-12701 | 66    | 8 pieces  | .....\$ 21.00 set |
| 67-12701 | 67    | 11 pieces | .....\$ 28.00 set |
| 68-12701 | 68    | 17 pieces | .....\$ 28.00 set |
| 69-12701 | 69    | 25 pieces | .....\$ 36.00 set |
| 70-12701 | 70    | 25 pieces | .....\$ 36.00 set |
| 71-12701 | 71-72 | 25 pieces | .....\$ 38.00 set |

## FUEL LINE CLIPS



|           |       |   |                   |
|-----------|-------|---|-------------------|
| 64-12705  | 64-65 | 5 pieces                                    | .....\$ 19.00 set |
| 66-12705  | 66    | 6 pieces                                    | .....\$ 21.00 set |
| 67-12705  | 67    | 6 pieces                                    | .....\$ 21.00 set |
| 68-12705  | 68    | 9 pieces                                    | .....\$ 22.00 set |
| 69-12705  | 69-72 | 3/8" main fuel line,<br>14 pieces           | .....\$ 21.00 set |
| 69-127051 | 69-72 | 3/8" main & 1/4" return<br>lines, 15 pieces | .....\$ 27.00 set |

## BRAKE LINE CLIP & JUNCTION BLOCK BOLT



|  |       |  |                  |
|--|-------|--|------------------|
| Original "E" headmark, 5/16-18 x 1/2". |       |  |                  |
| 67-12708                               | 62-74 |  | .....\$ 1.50 ea. |

## LINE CLIPS



|          |                            |                  |
|----------|----------------------------|------------------|
| 67-12680 | 2 line, push in            | .....\$ 4.00 ea. |
| 67-12681 | 2 line, rivet style        | .....\$ 5.00 ea. |
| 67-12682 | frame clip, bolt on, black | .....\$ 5.00 ea. |



|          |                        |                  |
|----------|------------------------|------------------|
| 67-12683 | 3/16", 1 line, snap in | .....\$ 3.00 ea. |
| 67-12684 | 1/4", 1 line, snap in  | .....\$ 3.00 ea. |

+ The following items require additional shipping and handling.

# CHEVROLET NOVA PARTS



Car Shop Inc. 739 North Batavia Orange, California 92868



## BOLTS

- 67-12770  1/4-20 x 1" with washer .....\$ .50 ea.  
 67-12771  1/4-20 x 1-3/16" with washer ...\$ .50 ea.

- 67-12772  5/16-18 x 3/4", pointed tip .....\$ .50 ea.  
 67-12773  5/16-18 x 7/8" with washer, pointed tip .....\$ .50 ea.

- 67-12774  5/16-18 x 1", pointed tip .....\$ .50 ea.





- 67-12775  5/16-18 x 1" with washer .....\$ .50 ea.  
 67-12776  3/8-16 x 1", pointed tip .....\$ .60 ea.  
 67-12777  3/8-16 x 1-1/2", with washer .....\$ .60 ea.

## FENDER TO COWL BOLTS





- 3/8-16 x 1 3/8, 9/16 hex, with 1.31 conical washer.  
 67-12778 68-74 4 pieces .....\$ 6.00 set

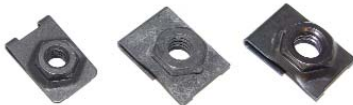

## J-NUTS

- 67-12780  Fits #8 screw .....\$ .50 ea.  
 67-12781  Fits #10 screw .....\$ .50 ea.



- With hex style nut.  
 67-12782  Fits 1/4-20 bolts .....\$ .60 ea.  
 67-12783  Fits 5/16-18 bolts .....\$ .60 ea.  
 67-12784  Fits 3/8-16 bolts .....\$ .60 ea.



- With tube style nut.  
 67-12785  Fits 1/4-20 bolts .....\$ .60 ea.  
 67-12786  Fits 5/16-18 bolts .....\$ .60 ea.  
 67-12787  Fits 3/8-16 bolts .....\$ .60 ea.



- With square style nut.  
 67-12788  Fits 7/16-14 bolts, short .....\$ .75 ea.

## SQUARE NUT INSERT



- 5/16-18, .49 x .69 x .21 thick. GM# 9418785.  
 67-12790 6 pieces .....\$ 5.00 set

## FRONT END BODY SHIMS

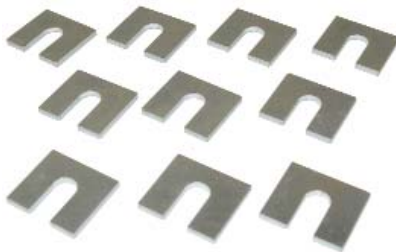

- Kits contain 10 shims.  
 67-12791 62-79 thin .....\$ 5.00 set  
 67-12792 62-79 thick .....\$ 5.00 set

## THREADED PLUGS



- 67-12793 Fits 1/4"-18 hole .....\$ 1.00 ea.  
 67-12794 Fits 3/8"-18 hole .....\$ 1.00 ea.  
 67-12795 Fits 1/2"-14 hole .....\$ 1.00 ea.

## STANDARD NUT



- 67-12796 3/8"-16 .....\$ .25 ea.  
 67-12797 7/16"-14 .....\$ .25 ea.

## SELF LOCKING NUTS



- 67-12798 #10-24 .....\$ .20 ea.  
 67-12799 1/4"-20 .....\$ .20 ea.

## EXTERNAL TOOTH LOCK WASHERS



- 67-12765 1/4" ID .....\$ .20 ea.  
 67-12766 5/8" ID .....\$ .20 ea.  
 67-12767 3/8" ID .....\$ .20 ea.  
 67-12768 7/16" ID .....\$ .20 ea.  
 67-12769 1/2" ID .....\$ .20 ea.

## UNDER HOOD DETAILING FASTENER KITS



Most Kits contain necessary fasteners for: Battery cable straps, headlight ground, park light ground, junction block, heater box nuts, heater hose to wheelhouse clip, horns, horn relay, radiator, fan shroud, ground straps, voltage regulator, washer jar bracket, wiper motor, wiring J-clips, regulator ground screws, wiper hose straps, wiring gutter to firewall screws and wiring harness nylon straps.

These items are not included in the Master Body Fastener Kits.  
 All kits include original style screws, nuts & bolts.

- 64-12754 64-66 (61 pieces) .....\$ 55.00 kit  
 67-12754 67 (64 pieces) .....\$ 55.00 kit  
 68-12754 68 (64 pieces) .....\$ 55.00 kit  
 69-12754 69-70 (63 pieces) .....\$ 55.00 kit  
 71-12754 71 (51 pieces) .....\$ 55.00 kit  
 72-12754 72 (53 pieces) .....\$ 55.00 kit

## BASIC FRONT END FASTENER KITS

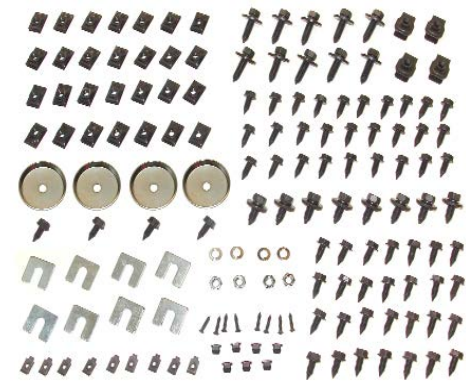

Kits contain necessary fasteners for the fenders, hood, core support, grill, headlight bezels, inner fenders and shims.  
 Black Oxide as original.

- 62-12709 62-67 .....\$ 44.00 ea.  
 68-12710 68-72 .....\$ 46.00 ea.

**Showroom hours:**  
**TUESDAY - FRIDAY: 8:30AM to 4:30PM**  
**SATURDAY: 8:30AM to 3:30PM**  
**Phone order desk hours:**  
**MONDAY - FRIDAY: 8:30AM to 4:30PM**  
[www.TruckandCarShop.com](http://www.TruckandCarShop.com)

† The following items require additional shipping and handling.



# CHEVROLET NOVA PARTS

Car Shop Inc. 739 North Batavia Orange, California 92868

## MASTER BODY FASTENER KITS



The hardware you need to properly reassemble your car body in one package. Each label includes assembly manual page number.

Most Kits contain necessary fasteners for: Battery tray, front & rear bumpers, front & rear bumper brackets, cowl vent panel, door latches, fender emblems, wheelhouse braces, fenders, fender tie bar, grill, grill brackets, grill molding, headlight adjusters, headlight bezels, headlight bodies, hood & hinges, hood catch & lock plate, hood latch support, hood adjusters, license plate brackets, license light, marker lights, mirror bracket, park lights, tail light body, trunk latch & striker, trunk lid & hinges, wheel opening moldings, wheelhouse to radiator support & more.

All kits include original style bolts with correct headmarks.

|          |       |              |                 |     |
|----------|-------|--------------|-----------------|-----|
| 64-12764 | 64    | (376 pieces) | ..... \$ 159.00 | kit |
| 65-12764 | 65    | (383 pieces) | ..... \$ 159.00 | kit |
| 66-12764 | 66    | (383 pieces) | ..... \$ 159.00 | kit |
| 67-12764 | 67    | (384 pieces) | ..... \$ 159.00 | kit |
| 68-12764 | 68    | (322 pieces) | ..... \$ 159.00 | kit |
| 69-12764 | 69    | (327 pieces) | ..... \$ 159.00 | kit |
| 70-12764 | 70    | (317 pieces) | ..... \$ 159.00 | kit |
| 71-12764 | 71-72 | (314 pieces) | ..... \$ 159.00 | kit |

Fastener kits are based on part numbers & finishes specified in the factory assembly manuals.

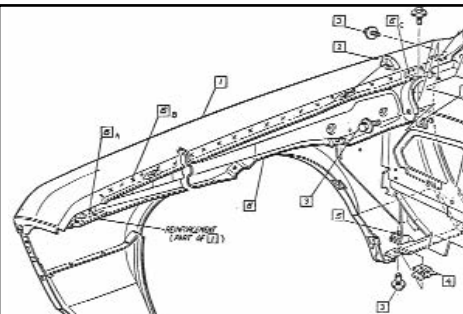

## MASTER CHASSIS FASTENER KITS



**Master Chassis Fastener Kits.** Most contain necessary fasteners for: Accelerator lever & support, axle retainer plates, brake booster, booster hose clamps, brake cables, brake hose retainers, brake line brackets, brake plate assembly, control arm bushings, control arms, differential cover, drive shaft, engine mounts, engine frame mounts, exhaust hangers, fuel hose clamps, gas tank, grease fittings, Idler arm, master cylinder, parking brake, pitman arm, shocks, speedometer cable, rear spring clamps, sway bar brackets, rag joint, steering gear box, centerlink & ball joint nuts, steering shaft, suspension bumpers, trans crossmember, trans insulator, wheel cylinders and more.

All kits include original style fasteners.

|          |       |   |                |     |
|----------|-------|---|----------------|-----|
| 64-12744 | 64-65 | 283, 327<br>Drum, (448 pieces)                | .... \$ 275.00 | kit |
| 66-12744 | 66    | 283, 327<br>Drum, (443 pieces)                | .... \$ 280.00 | kit |
| 67-12744 | 67    | 283, 327<br>Drum, (449 pieces)                | .... \$ 280.00 | kit |
| 67-12745 | 67    | 283, 327<br>Disc, (449 pieces)                | .... \$ 295.00 | kit |
| 68-12745 | 68    | 307,327,350, mono leaf<br>Drum, (338 pieces)  | .... \$ 250.00 | kit |
| 68-12746 | 68    | 307,327,350, multi leaf<br>Drum, (336 pieces) | .... \$ 260.00 | kit |
| 68-12747 | 68    | 307,327,350, mono leaf<br>Disc, (345 pieces)  | .... \$ 270.00 | kit |
| 68-12748 | 68    | 307,327,350, multi leaf<br>Disc, (343 pieces) | .... \$ 275.00 | kit |
| 68-12749 | 68    | 396, multi leaf<br>Disc, (344 pieces)         | .... \$ 280.00 | kit |
| 69-12745 | 69    | S/B, mono leaf<br>Drum, (348 pieces)          | .... \$ 260.00 | kit |
| 69-12746 | 69    | S/B, multi leaf<br>Drum, (352 pieces)         | .... \$ 270.00 | kit |
| 69-12747 | 69    | S/B, mono leaf<br>Disc, (345 pieces)          | .... \$ 275.00 | kit |
| 69-12748 | 69    | S/B, multi leaf<br>Disc, (351 pieces)         | .... \$ 280.00 | kit |
| 69-12749 | 69    | 396, multi leaf<br>Disc, (352 pieces)         | .... \$ 285.00 | kit |

## MASTER CHASSIS FASTENER KITS

**Master Chassis Fastener Kits.**

|          |       |   |                |     |
|----------|-------|---|----------------|-----|
| 70-12745 | 70    | Nova, S/B, mono leaf<br>Drum, (346 pieces)  | .... \$ 265.00 | kit |
| 70-12746 | 70    | Nova, S/B, multi leaf<br>Drum, (350 pieces) | .... \$ 270.00 | kit |
| 70-12747 | 70    | Nova, S/B, mono leaf<br>Disc, (344 pieces)  | .... \$ 280.00 | kit |
| 70-12748 | 70    | Nova, S/B, multi leaf<br>Disc, (374 pieces) | .... \$ 295.00 | kit |
| 70-12749 | 70    | Nova, 396, multi leaf<br>Disc, (375 pieces) | .... \$ 300.00 | kit |
| 71-12745 | 71-72 | Nova, S/B, mono leaf<br>Drum, (353 pieces)  | .... \$ 270.00 | kit |
| 71-12746 | 71-72 | Nova, S/B, multi leaf<br>Drum, (349 pieces) | .... \$ 280.00 | kit |
| 71-12747 | 71-72 | Nova, S/B, mono leaf<br>Disc, (356 pieces)  | .... \$ 285.00 | kit |
| 71-12748 | 71-72 | Nova, S/B, multi leaf<br>Disc, (378 pieces) | .... \$ 300.00 | kit |

Fastener kits are based on part numbers & finishes specified in the factory assembly manuals.

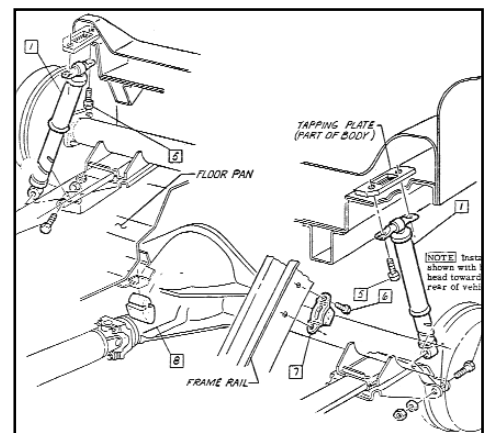

✦ The following items require additional shipping and handling.



# CHEVROLET NOVA PARTS



Car Shop Inc. 739 North Batavia Orange, California 92868

## HOOD HINGES



- 63-10620 63-65 LH, black .....\$ 45.00 ea.
- 63-10621 63-65 RH, black .....\$ 45.00 ea.



- 67-12712 66-67 LH, black, repro .....\$ 40.00 ea.
- 67-12713 66-67 RH, black, repro .....\$ 40.00 ea.

Correct dark gray phosphate plated just like GM hinges. Original gauge material, accurately stamped from high strength steel, hardened pivot points. OE Quality. Spring not included.

- 67-127121 66-67 LH, phosphate .....\$ 112.00 ea.
- 67-127131 66-67 RH, phosphate .....\$ 112.00 ea.

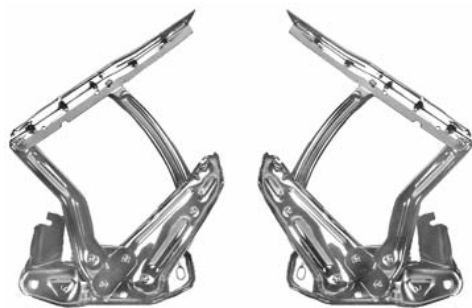

- 67-127155 66-67 LH & RH, chrome .....\$ 349.00 ea.



- 68-106233 68-79 LH .....\$ 47.00 ea.
- 68-106234 68-79 RH .....\$ 47.00 ea.

## HOOD HINGES



Correct dark gray phosphate plated just like GM hinges. Original gauge material, accurately stamped from high strength steel, hardened pivot points. OE Quality. Includes INSTALLED matte black spring.

- 68-096145 68-79 LH .....\$ 94.00 ea.
- 68-096146 68-79 RH .....\$ 94.00 ea.

## HOOD HINGE BOLT KIT



- 3/8-16 x 13/16, 9/16 hex, with star washer. Silver zinc.
- 64-096244 62-64 All .....\$ 6.00 kit



- 3/8-16 x 13/16, 9/16 hex, with 1" conical washer. Black oxide.
- 67-127175 64-79 4 pieces .....\$ 6.00 kit

## HOOD HINGE SPRING



- Replaces GM #3848272.
- 67-127191 63-64 reproduction .....\$ 14.00 ea.
- 67-12719 63-64 GM .....\$ 19.00 ea.



- Replaces GM #3864680 & #3926800.
- 66-09623 65
- 68-72 .....\$ 22.00 ea.



- Replaces GM #3877203 & #409025.
- 67-12718 66-67
- 73-79 .....\$ 12.00 ea.

## HOOD LATCH



- 68-12721 68-72 .....\$ 41.00 ea.

## HOOD CATCH & LOCK PLATE BOLTS



- 62-12730 62-65 15 pieces .....\$ 7.00 kit
- 66-12730 66-67 10 pieces .....\$ 6.00 kit
- 68-12730 68-70 11 pieces .....\$ 9.00 kit



- 71-12730 71-72 11 pieces .....\$ 11.00 kit

## HOOD LATCH SUPPORT



This is the support that mounts between the grill and the radiator core support, below the hood latch.

- 66-12801 66 .....\$ 34.00 ea.
- 67-12802 67 .....\$ 34.00 ea.
- 70-12802 68-72 .....\$ 23.00 ea.

• CAR SHOP • BEST QUALITY! •  
• BEST PRICE! •

+ The following items require additional shipping and handling.

Fax Order 1-714-771-0407 • Toll Free 1-800-235-2470 • [www.TruckandCarShop.com](http://www.TruckandCarShop.com) • 2014 Catalog



# CHEVROLET NOVA PARTS

Car Shop Inc. 739 North Batavia Orange, California 92868

## HOOD LATCH CATCH ASSEMBLY



66-12725 66 .....\$ 85.00 ea.



68-12725 68-72 .....\$ 85.00 ea.

## HOOD INSULATION KIT



62-12805 62-65 .....\$ 20.00 kit  
 66-12805 66-67 .....\$ 20.00 kit  
 68-12805 68-72 .....\$ 20.00 kit

## HOODS

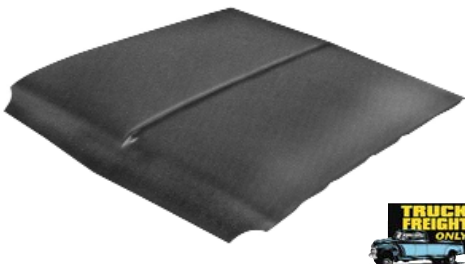

### STANDARD HOOD

62-12811+ 62-65 steel .....\$ 289.00 ea.  
 66-12811+ 66-67 steel .....\$ 299.00 ea.

## HOODS



68-12811+ 68-72 steel .....\$ 349.00 ea.



62-12812+ 62-65 steel, 2" tall .....\$ 365.00 ea.



66-12812+ 66-67 steel, 2" tall .....\$ 359.00 ea.



68-12812+ 68-72 steel, 2" tall .....\$ 389.00 ea.  
 68-12813+ 68-72 steel, 4" tall .....\$ 389.00 ea.  
 73-12812+ 73-74 steel, 2" tall .....\$ 365.00 ea.

## "SS" HOOD INSERTS



67-129012 68-72 LH & RH, import .....\$ 147.00 pr.  
 Made from original GM tooling!  
 67-12901 68-72 LH or RH, USA .....\$ 115.00 ea.

## "SS" HOOD INSERT CHROME BEZEL



68-129021 68-72 LH or RH, import .....\$ 39.00 ea.  
 Made from original GM tooling!  
 68-12902 68-72 LH or RH, USA .....\$ 73.00 ea.

## "SS" HOOD INSERT REINFORCEMENT BRACKETS



68-129022 68-72 .....\$ 16.00 pr.

## "SS" HOOD INSERT SEALS

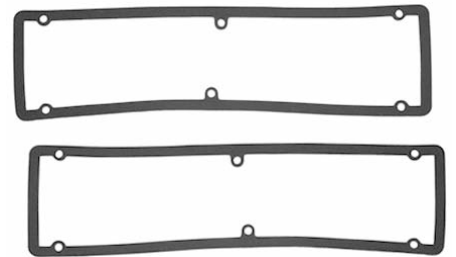

New correct style hood louver gaskets.  
 68-12903 68-72 .....\$ 11.00 pr.

## COWL VENT PANELS



This is the panel that fits directly in front of the windshield.  
 66-12904+ 66-67 .....\$ 239.00 ea.



68-12904+ 68-72 .....\$ 209.00 ea.

## COWL PANEL SCREW KIT



67-12907 68-72 4 pieces .....\$ 3.50 kit

+ The following items require additional shipping and handling.

# CHEVROLET NOVA PARTS



Car Shop Inc. 739 North Batavia Orange, California 92868

## OUTER COWL PANELS



New Weld through primer.

|          |       |    |       |          |     |
|----------|-------|----|-------|----------|-----|
| 66-12908 | 66-67 | LH | ..... | \$ 62.00 | ea. |
| 66-12909 | 66-67 | RH | ..... | \$ 62.00 | ea. |

## OUTER COWL PANEL INNER SHOULDER



New Weld through primer.

|           |       |    |       |           |     |
|-----------|-------|----|-------|-----------|-----|
| 66-129091 | 66-67 | LH | ..... | \$ 118.00 | ea. |
| 66-129092 | 66-67 | RH | ..... | \$ 118.00 | ea. |

## DASH TOP PANEL



This steel dash panel fits under the dash pad and extends under the windshield.

|           |       |       |          |     |
|-----------|-------|-------|----------|-----|
| 68-12912+ | 68-74 | ..... | \$ 85.00 | ea. |
|-----------|-------|-------|----------|-----|

## COMPLETE DASH PANEL



This steel dash panel includes the dash top panel.

|            |       |       |           |     |
|------------|-------|-------|-----------|-----|
| 66-129121+ | 66-67 | ..... | \$ 359.00 | ea. |
|------------|-------|-------|-----------|-----|



|            |       |            |       |           |     |
|------------|-------|------------|-------|-----------|-----|
| 69-129121+ | 69-72 | Without AC | ..... | \$ 289.00 | ea. |
|------------|-------|------------|-------|-----------|-----|



|            |       |         |       |           |     |
|------------|-------|---------|-------|-----------|-----|
| 69-129125+ | 69-72 | With AC | ..... | \$ 289.00 | ea. |
|------------|-------|---------|-------|-----------|-----|

## COWL PANELS



Lower cowl panel.

|           |       |       |           |     |
|-----------|-------|-------|-----------|-----|
| 66-12913+ | 66-67 | ..... | \$ 245.00 | ea. |
|-----------|-------|-------|-----------|-----|



|           |       |         |       |           |     |
|-----------|-------|---------|-------|-----------|-----|
| 70-12913+ | 70-72 | with AC | ..... | \$ 369.00 | ea. |
|-----------|-------|---------|-------|-----------|-----|

## FIREWALL PANELS



New Weld through primer.

|           |       |       |           |     |
|-----------|-------|-------|-----------|-----|
| 66-12916+ | 66-67 | ..... | \$ 349.00 | ea. |
|-----------|-------|-------|-----------|-----|

## FIREWALL TO FLOOR BRACES

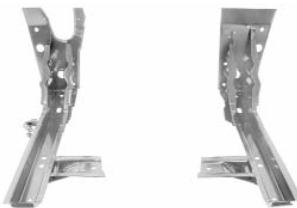

New Weld through primer.

|           |       |       |           |     |
|-----------|-------|-------|-----------|-----|
| 66-12919+ | 66-67 | ..... | \$ 255.00 | pr. |
|-----------|-------|-------|-----------|-----|

## BUMPER FILLER PANELS



|           |       |       |          |     |
|-----------|-------|-------|----------|-----|
| 62-12935+ | 62-65 | ..... | \$ 62.00 | ea. |
|-----------|-------|-------|----------|-----|



|           |       |       |          |     |
|-----------|-------|-------|----------|-----|
| 66-12935+ | 66-67 | ..... | \$ 62.00 | ea. |
|-----------|-------|-------|----------|-----|



|           |       |                     |       |          |     |
|-----------|-------|---------------------|-------|----------|-----|
| 68-12935+ | 68-72 | steel reinforcement | ..... | \$ 62.00 | ea. |
|-----------|-------|---------------------|-------|----------|-----|



|           |       |                   |       |          |     |
|-----------|-------|-------------------|-------|----------|-----|
| 68-12936+ | 68-72 | fiberglass filler | ..... | \$ 40.00 | ea. |
|-----------|-------|-------------------|-------|----------|-----|

## FENDER BRACE RODS



|          |       |         |       |          |     |
|----------|-------|---------|-------|----------|-----|
| 62-13008 | 62-65 | LH & RH | ..... | \$ 10.00 | pr. |
| 66-13008 | 66-67 | LH & RH | ..... | \$ 10.00 | pr. |
| 68-13008 | 68-72 | LH & RH | ..... | \$ 10.00 | pr. |

## FENDERS



|           |       |    |       |           |     |
|-----------|-------|----|-------|-----------|-----|
| 62-13012+ | 62-65 | LH | ..... | \$ 209.00 | ea. |
| 62-13013+ | 62-65 | RH | ..... | \$ 209.00 | ea. |



|           |    |    |       |           |     |
|-----------|----|----|-------|-----------|-----|
| 66-13016+ | 66 | LH | ..... | \$ 375.00 | ea. |
| 66-13017+ | 66 | RH | ..... | \$ 375.00 | ea. |
| 67-13018+ | 67 | LH | ..... | \$ 359.00 | ea. |
| 67-13019+ | 67 | RH | ..... | \$ 359.00 | ea. |



|           |       |    |       |           |     |
|-----------|-------|----|-------|-----------|-----|
| 68-13022+ | 68-69 | LH | ..... | \$ 345.00 | ea. |
| 68-13023+ | 68-69 | RH | ..... | \$ 345.00 | ea. |



|           |       |    |       |           |     |
|-----------|-------|----|-------|-----------|-----|
| 70-13027+ | 70-74 | LH | ..... | \$ 294.00 | ea. |
| 70-13028+ | 70-74 | RH | ..... | \$ 294.00 | ea. |

+ The following items require additional shipping and handling.



# CHEVROLET NOVA PARTS

Car Shop Inc. 739 North Batavia Orange, California 92868

## FENDER PATCH PANELS



This patch panel fits behind the front wheel well opening.

|          |       |              |              |
|----------|-------|--------------|--------------|
| 62-13035 | 62-65 | LH, 14" tall | \$ 60.00 ea. |
| 62-13036 | 62-65 | RH, 14" tall | \$ 60.00 ea. |
| 68-13035 | 68-74 | LH           | \$ 74.00 ea. |
| 68-13036 | 68-74 | RH           | \$ 74.00 ea. |

## FRONT INNER FENDER ASSEMBLY



Complete with shock tower and frame rail.  
Black EDP primer.

|           |       |    |               |
|-----------|-------|----|---------------|
| 66-13041+ | 66-67 | LH | \$ 619.00 ea. |
| 66-13042+ | 66-67 | RH | \$ 619.00 ea. |

New Weld through primer.

|           |       |    |               |
|-----------|-------|----|---------------|
| 66-13043+ | 66-67 | LH | \$ 669.00 ea. |
| 66-13044+ | 66-67 | RH | \$ 669.00 ea. |

## FRONT INNER FENDER ASSEMBLY BOLT KIT



Front inner fender/wheelhouse bolt kit

|          |       |           |              |
|----------|-------|-----------|--------------|
| 62-13060 | 62-65 | 34 pieces | \$ 15.00 kit |
|----------|-------|-----------|--------------|

Front inner fender/wheelhouse bolt kit

|          |       |           |              |
|----------|-------|-----------|--------------|
| 66-13060 | 66-67 | 36 pieces | \$ 17.00 kit |
|----------|-------|-----------|--------------|



Front inner wheelhouse to body bolt kit

|          |       |           |              |
|----------|-------|-----------|--------------|
| 62-13061 | 62-67 | 38 pieces | \$ 18.00 kit |
|----------|-------|-----------|--------------|

## OUTER SHOCK TOWER PANEL



|           |       |    |              |
|-----------|-------|----|--------------|
| 66-13045+ | 66-67 | LH | \$ 52.00 ea. |
| 66-13046+ | 66-67 | RH | \$ 52.00 ea. |

## FRONT INNER FENDER SKIRT



|           |       |    |               |
|-----------|-------|----|---------------|
| 68-13041+ | 68-74 | LH | \$ 115.00 ea. |
| 68-13042+ | 68-74 | RH | \$ 115.00 ea. |

## FENDER SKIRT TO FIREWALL BRACES



|          |       |    |              |
|----------|-------|----|--------------|
| 67-13049 | 68-74 | LH | \$ 21.00 ea. |
| 67-13050 | 68-74 | RH | \$ 21.00 ea. |

## DOOR OPENING BODY PANEL ASSEMBLY



New Weld through primer. Special order, truck freight only.

|           |       |    |                |
|-----------|-------|----|----------------|
| 66-13063+ | 66-67 | LH | \$ 1129.00 ea. |
| 66-13064+ | 66-67 | RH | \$ 1129.00 ea. |

## DOOR SKINS



This is the outer panel that mounts to the door frame skeleton.

|           |       |                    |               |
|-----------|-------|--------------------|---------------|
| 62-13101+ | 62-65 | LH, 2-door hardtop | \$ 147.00 ea. |
|           | 62-63 | LH, convertible    |               |
| 62-13102+ | 62-65 | RH, 2-door hardtop | \$ 147.00 ea. |
|           | 62-63 | RH, convertible    |               |

## DOOR SKINS



|           |       |                    |               |
|-----------|-------|--------------------|---------------|
| 66-13103+ | 66-67 | LH, 2-door hardtop | \$ 159.00 ea. |
| 66-13104+ | 66-67 | RH, 2-door hardtop | \$ 159.00 ea. |



|           |       |            |               |
|-----------|-------|------------|---------------|
| 68-13105+ | 68-72 | LH, 2-door | \$ 139.00 ea. |
| 68-13106+ | 68-72 | RH, 2-door | \$ 139.00 ea. |

## COMPLETE DOOR SHELLS



|           |       |                    |               |
|-----------|-------|--------------------|---------------|
| 62-13109+ | 62-65 | LH, 2-door hardtop | \$ 419.00 ea. |
|           | 62-65 | LH, convertible    |               |

|           |       |                    |               |
|-----------|-------|--------------------|---------------|
| 62-13110+ | 62-65 | RH, 2-door hardtop | \$ 419.00 ea. |
|           | 62-65 | RH, convertible    |               |



|           |       |                                    |               |
|-----------|-------|------------------------------------|---------------|
| 66-13109+ | 66    | LH                                 | \$ 389.00 ea. |
| 66-13110+ | 66    | RH                                 | \$ 389.00 ea. |
| 67-13111+ | 67    | LH                                 | \$ 389.00 ea. |
| 67-13112+ | 67    | RH                                 | \$ 389.00 ea. |
| 68-13109+ | 68-72 | LH, 2-door sedan with window frame | \$ 449.00 ea. |
| 68-13110+ | 68-72 | RH, 2-door sedan with window frame | \$ 449.00 ea. |

+ The following items require additional shipping and handling.

# CHEVROLET NOVA PARTS



Car Shop Inc. 739 North Batavia Orange, California 92868

## OUTER ROCKER PANELS



Steel panel that fits below the door and between the wheel openings.  
Fits all 1962-1967 models except 1962-63 convertible.

|           |       |    |       |           |     |
|-----------|-------|----|-------|-----------|-----|
| 62-13121+ | 62-67 | LH | ..... | \$ 99.00  | ea. |
| 62-13122+ | 62-67 | RH | ..... | \$ 99.00  | ea. |
| 68-13121+ | 68-72 | LH | ..... | \$ 139.00 | ea. |
| 68-13122+ | 68-72 | RH | ..... | \$ 139.00 | ea. |

## INNER & OUTER ROCKER PANEL COMPLETE



|           |       |    |       |           |     |
|-----------|-------|----|-------|-----------|-----|
| 62-13123+ | 62-67 | LH | ..... | \$ 239.00 | ea. |
| 62-13124+ | 62-67 | RH | ..... | \$ 239.00 | ea. |

## INNER ROCKER PANEL



|           |       |    |       |          |     |
|-----------|-------|----|-------|----------|-----|
| 68-13125+ | 68-72 | LH | ..... | \$ 99.00 | ea. |
| 68-13126+ | 68-72 | RH | ..... | \$ 99.00 | ea. |

## KICK PANEL SUPPORT TO ROCKER



|          |       |    |       |          |     |
|----------|-------|----|-------|----------|-----|
| 68-13150 | 68-72 | LH | ..... | \$ 48.00 | ea. |
| 68-13151 | 68-72 | RH | ..... | \$ 48.00 | ea. |

## TAIL LIGHT PATCH PANELS



|          |       |    |       |          |     |
|----------|-------|----|-------|----------|-----|
| 62-13125 | 62-64 | LH | ..... | \$ 54.00 | ea. |
| 62-13126 | 62-64 | RH | ..... | \$ 54.00 | ea. |



|          |       |    |       |          |     |
|----------|-------|----|-------|----------|-----|
| 66-13125 | 66-67 | LH | ..... | \$ 56.00 | ea. |
| 66-13126 | 66-67 | RH | ..... | \$ 56.00 | ea. |

## REAR BODY PANEL

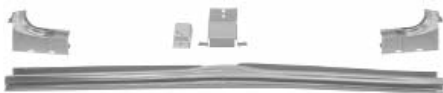

New Weld through primer.

|           |       |          |       |           |     |
|-----------|-------|----------|-------|-----------|-----|
| 66-13127+ | 66-67 | 5 pieces | ..... | \$ 107.00 | ea. |
|-----------|-------|----------|-------|-----------|-----|



New Weld through primer.

|           |       |                   |      |           |     |
|-----------|-------|-------------------|------|-----------|-----|
| 66-13128+ | 66-67 | complete assembly | .... | \$ 349.00 | ea. |
|-----------|-------|-------------------|------|-----------|-----|



Black EDP primer.

|           |       |       |       |           |     |
|-----------|-------|-------|-------|-----------|-----|
| 68-13127+ | 68-69 | ..... | ..... | \$ 115.00 | ea. |
|-----------|-------|-------|-------|-----------|-----|



Black EDP primer.

|           |       |       |       |           |     |
|-----------|-------|-------|-------|-----------|-----|
| 70-13128+ | 70-72 | ..... | ..... | \$ 115.00 | ea. |
|-----------|-------|-------|-------|-----------|-----|



Black EDP primer.

|           |       |       |       |           |     |
|-----------|-------|-------|-------|-----------|-----|
| 73-13128+ | 73-74 | ..... | ..... | \$ 149.00 | ea. |
|-----------|-------|-------|-------|-----------|-----|

## QUARTER PANEL SKINS



Black EDP primer.

|           |       |    |       |           |     |
|-----------|-------|----|-------|-----------|-----|
| 68-13134+ | 68-69 | LH | ..... | \$ 145.00 | ea. |
| 68-13135+ | 68-69 | RH | ..... | \$ 145.00 | ea. |



Black EDP primer.

|           |       |    |       |           |     |
|-----------|-------|----|-------|-----------|-----|
| 70-13134+ | 70-72 | LH | ..... | \$ 150.00 | ea. |
| 70-13135+ | 70-72 | RH | ..... | \$ 150.00 | ea. |

## FULL QUARTER PANELS



This panel includes correct door jamb area, does not include sail panel.  
New Weld through primer.

|           |       |    |       |           |     |
|-----------|-------|----|-------|-----------|-----|
| 62-13201+ | 62-65 | LH | ..... | \$ 279.00 | ea. |
| 62-13202+ | 62-65 | RH | ..... | \$ 279.00 | ea. |



This panel includes correct door jamb area & sail panel.  
Black EDP primer.

|           |       |    |       |           |     |
|-----------|-------|----|-------|-----------|-----|
| 66-13201+ | 66-67 | LH | ..... | \$ 397.00 | ea. |
| 66-13202+ | 66-67 | RH | ..... | \$ 397.00 | ea. |



This panel includes correct door jamb area & sail panel (not attached).  
Black EDP primer.

|           |       |    |       |           |     |
|-----------|-------|----|-------|-----------|-----|
| 68-13201+ | 68-69 | LH | ..... | \$ 359.00 | ea. |
| 68-13202+ | 68-69 | RH | ..... | \$ 359.00 | ea. |



This panel includes correct door jamb area & sail panel (not attached).  
Black EDP primer.

|           |       |    |       |           |     |
|-----------|-------|----|-------|-----------|-----|
| 70-13201+ | 70-72 | LH | ..... | \$ 359.00 | ea. |
| 70-13202+ | 70-72 | RH | ..... | \$ 359.00 | ea. |

## REAR QUARTER PATCH PANELS



Lower Rear

|          |       |                   |       |          |     |
|----------|-------|-------------------|-------|----------|-----|
| 66-13225 | 66-67 | LH, 8" tall x 32" | ..... | \$ 57.00 | ea. |
| 66-13226 | 66-67 | RH, 8" tall x 32" | ..... | \$ 57.00 | ea. |

+ The following items require additional shipping and handling.

Fax Order 1-714-771-0407 • Toll Free 1-800-235-2470 • [www.TruckandCarShop.com](http://www.TruckandCarShop.com) • 2014 Catalog



# CHEVROLET NOVA PARTS

Car Shop Inc. 739 North Batavia Orange, California 92868

## REAR WHEEL OPENING PATCH PANELS



- |          |       |                              |              |
|----------|-------|------------------------------|--------------|
| 62-13215 | 62-65 | LH, 15" tall x 38" . . . . . | \$ 66.00 ea. |
| 62-13216 | 62-65 | RH, 15" tall x 38" . . . . . | \$ 66.00 ea. |
| 66-13215 | 66-67 | LH, 13" tall x 31" . . . . . | \$ 66.00 ea. |
| 66-13216 | 66-67 | RH, 13" tall x 31" . . . . . | \$ 66.00 ea. |

## ROOF PANEL



Black EDP primer.

- |           |       |       |               |
|-----------|-------|-------|---------------|
| 66-13233+ | 66-67 | ..... | \$ 339.00 ea. |
| 68-13233+ | 68-72 | ..... | \$ 389.00 ea. |

## ROOF PANEL BRACE KIT



- |           |       |                 |               |
|-----------|-------|-----------------|---------------|
| 66-13234+ | 66-67 | 13 pcs. . . . . | \$ 209.00 kit |
|-----------|-------|-----------------|---------------|

## ROOF DRIP RAIL SUPPORTS



- |            |       |                           |               |
|------------|-------|---------------------------|---------------|
| 66-132363+ | 66-67 | LH & RH, roof sides . . . | \$ 109.00 pr. |
|------------|-------|---------------------------|---------------|

## WINDSHIELD PILLAR PANEL



New Weld through primer.

- |            |       |              |              |
|------------|-------|--------------|--------------|
| 66-132366+ | 66-67 | LH . . . . . | \$ 39.00 ea. |
| 66-132367+ | 66-67 | RH . . . . . | \$ 39.00 ea. |

## REAR OUTER WHEELHOUSE PANEL



New replacement for this commonly rusted part.  
Black EDP primer.

- |           |       |              |              |
|-----------|-------|--------------|--------------|
| 62-13237+ | 62-65 | LH . . . . . | \$ 68.00 ea. |
| 62-13238+ | 62-65 | RH . . . . . | \$ 68.00 ea. |
| 66-13237+ | 66-67 | LH . . . . . | \$ 68.00 ea. |
| 66-13238+ | 66-67 | RH . . . . . | \$ 68.00 ea. |
| 68-13237+ | 68-74 | LH . . . . . | \$ 97.00 ea. |
| 68-13238+ | 68-74 | RH . . . . . | \$ 97.00 ea. |

## REAR INNER WHEELHOUSE PANEL



Black EDP primer.

- |           |       |              |               |
|-----------|-------|--------------|---------------|
| 68-13246+ | 68-74 | LH . . . . . | \$ 119.00 ea. |
| 68-13247+ | 68-74 | RH . . . . . | \$ 119.00 ea. |

## REAR INNER & OUTER WHEELHOUSE COMPLETE



New Weld through primer.

- |           |       |              |               |
|-----------|-------|--------------|---------------|
| 66-13250+ | 66-67 | LH . . . . . | \$ 195.00 ea. |
| 66-13251+ | 66-67 | RH . . . . . | \$ 195.00 ea. |

## BELOW REAR WINDOW PANEL



Located below the rear window in front of the trunk lid.  
New Weld through primer.

- |           |       |       |              |
|-----------|-------|-------|--------------|
| 66-13313+ | 66-67 | ..... | \$ 84.00 ea. |
|-----------|-------|-------|--------------|



New Weld through primer.

- |           |       |       |               |
|-----------|-------|-------|---------------|
| 66-13313+ | 68-72 | ..... | \$ 105.00 ea. |
|-----------|-------|-------|---------------|

## TRUNK HINGES



- |           |       |       |               |
|-----------|-------|-------|---------------|
| 66-133155 | 66-67 | ..... | \$ 135.00 pr. |
|-----------|-------|-------|---------------|

## TRUNK SPRING RODS



- |          |       |                   |              |
|----------|-------|-------------------|--------------|
| 66-13317 | 66-67 | LH & RH . . . . . | \$ 45.00 pr. |
|----------|-------|-------------------|--------------|

## TRUNK LIDS



- |           |       |       |               |
|-----------|-------|-------|---------------|
| 62-13321+ | 62-64 | ..... | \$ 299.00 ea. |
|-----------|-------|-------|---------------|



- |           |    |       |               |
|-----------|----|-------|---------------|
| 65-13321+ | 65 | ..... | \$ 299.00 ea. |
|-----------|----|-------|---------------|



- |           |       |       |               |
|-----------|-------|-------|---------------|
| 66-13321+ | 66-67 | ..... | \$ 299.00 ea. |
|-----------|-------|-------|---------------|



- |           |       |                          |               |
|-----------|-------|--------------------------|---------------|
| 68-13321+ | 68-74 | exc. hatchback . . . . . | \$ 209.00 ea. |
|-----------|-------|--------------------------|---------------|

## TRUNK LATCH MOUNTING BRACKET



- |          |       |       |              |
|----------|-------|-------|--------------|
| 68-13325 | 68-70 | ..... | \$ 59.00 ea. |
|----------|-------|-------|--------------|

## TRUNK LID BOLT KIT



- |          |       |                    |             |
|----------|-------|--------------------|-------------|
| 67-13322 | 62-74 | 4 pieces . . . . . | \$ 4.00 kit |
|----------|-------|--------------------|-------------|

+ The following items require additional shipping and handling.

# CHEVROLET NOVA PARTS



Car Shop Inc. 739 North Batavia Orange, California 92868

## TRUNK GUTTER SIDE BRACE



68-13415 68-69 LH .....\$ 43.00 ea.  
68-13416 68-69 RH .....\$ 43.00 ea.



70-13340 70 LH .....\$ 47.00 ea.  
70-13341 70 RH .....\$ 47.00 ea.  
71-13340 71-72 LH .....\$ 44.00 ea.  
71-13341 71-72 RH .....\$ 44.00 ea.

## TRUNK FLOORS



New Weld through primer.  
62-13401+ 62-67 .....\$ 79.00 ea.



Trunk floor with side extensions, 3 pieces with metal floor plugs.  
Black EDP primer.  
62-13402+ 62-67 .....\$ 219.00 set



Black EDP primer.  
68-13401+ 68-74 .....\$ 77.00 ea.

## TRUNK FLOOR PAN WITH BRACES



Includes trunk floor braces & straps. New Weld through primer.  
62-13405+ 62-67 .....\$ 385.00 ea.



Includes trunk floor braces. Black EDP primer.  
68-13405+ 68-70 .....\$ 549.00 ea.  
71-13405+ 71-72 .....\$ 549.00 ea.

## COMPLETE TRUNK FLOOR PAN ASSEMBLY



Includes trunk floor & rear seat floor pan with frame rails & braces.  
New Weld through primer.  
62-13406+ 62-67 .....\$1289.00 ea.

## TRUNK FLOOR EXTENSION PANEL



Black EDP primer.  
68-13407 68-72 LH .....\$ 64.00 ea.  
68-13408 68-72 RH .....\$ 64.00 ea.

## TRUNK FLOOR-TO-1/4 PANEL DROP OFF PANEL



New Weld through primer.  
62-13411 62-67 LH .....\$ 54.00 ea.  
62-13412 62-67 RH .....\$ 54.00 ea.



Black EDP primer.  
68-13411 68-72 LH .....\$ 57.00 ea.  
68-13412 68-72 RH .....\$ 57.00 ea.

## TRUNK FLOOR DROP OFF EXTENSION PANEL



Black EDP primer.  
68-13413 68-72 LH .....\$ 57.00 ea.  
68-13414 68-72 RH .....\$ 57.00 ea.

## TRUNK FLOOR SHOCK TOWER PANELS



Black EDP primer.  
68-13417 68-74 LH .....\$ 49.00 ea.  
68-13419 68-72 RH .....\$ 49.00 ea.



Lower rear shock mount reinforcement plate.  
68-13420 68-74 LH or RH .....\$ 15.00 ea.

## TRUNK FLOOR BRACE



Black EDP primer.  
62-13421 62-67 LH or RH .....\$ 35.00 ea.



Black EDP primer.  
68-13421 68-72 LH .....\$ 43.00 ea.  
68-13422 68-72 RH .....\$ 43.00 ea.

+ The following items require additional shipping and handling.

Fax Order 1-714-771-0407 • Toll Free 1-800-235-2470 • [www.TruckandCarShop.com](http://www.TruckandCarShop.com) • 2014 Catalog



# CHEVROLET NOVA PARTS

Car Shop Inc. 739 North Batavia Orange, California 92868

## FLOOR PANS



- 62-13423+ 62-67 LH .....\$ 76.00 ea.
- 62-13424+ 62-67 RH .....\$ 76.00 ea.



- 68-13425+ 68-76 LH .....\$ 78.00 ea.
- 68-13426+ 68-76 RH .....\$ 78.00 ea.

## COMPLETE FLOOR PAN

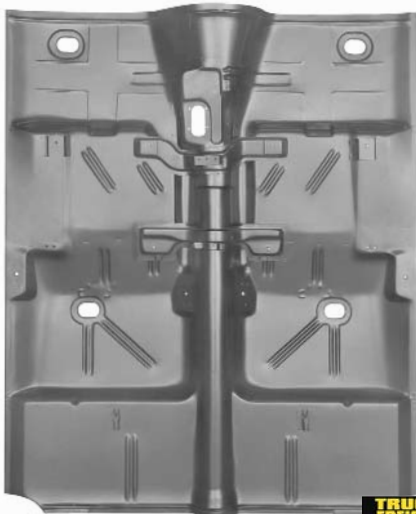

- 1-piece full floor, features new weld through primer.
- 62-13501+ 62-67 for automatic trans includes shift hump ...\$ 499.00 ea.
  - 62-13502+ 62-67 no shift hole .....\$ 429.00 ea.

## COMPLETE FLOOR PAN

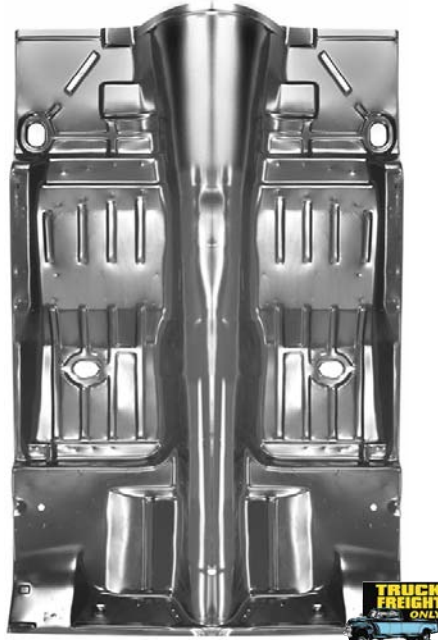

- 68-13501+ 68-74 1-piece full floor .....\$ 559.00 ea.

## FLOOR PAN BRACE



- 62-13450 62-67 Front, LH or RH .....\$ 80.00 ea.



- 62-13451 62-67 center, LH .....\$ 79.00 ea.
- 62-13452 62-67 center, RH .....\$ 79.00 ea.

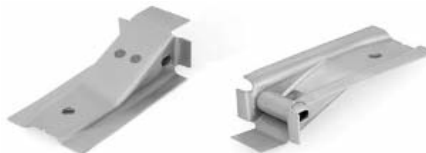

Transmission crossmember mounting brace, welds to floor between the front & center floor pan braces.

- 62-13453 62-67 LH .....\$ 64.00 ea.
- 62-13454 62-67 RH .....\$ 64.00 ea.

## Car Shop Sheet Metal

All panels are carefully packaged to protect against damage that may occur during transit. Most parts are individually boxed for damage free shipping. However, after transport & cross country delivery to you, it is likely there could be a small ding or minor scratch.

These minor blemishes cannot be helped and are considered normal due to the nature of the product. Any physical damage in transit must be reported to delivering carrier at time of delivery. Test fit all panels prior to paint and installation.

## REAR SEAT FLOOR PAN



- New Weld through primer.
- 62-13440+ 62-67 .....\$ 275.00 ea.

## UNDER REAR SEAT FLOOR PAN BRACE



- 68-13442 68-74 LH .....\$ 55.00 ea.
- 68-13443 68-74 RH .....\$ 55.00 ea.

## TRUNK DIVIDER PANEL WITH PACKAGE TRAY



- Includes trunk lid hinges & torsion rods.
- 66-135105+ 66-67 .....\$ 489.00 ea.

## FLOOR PAN REAR CROSS RAIL



- 68-13514 68-72 .....\$ 124.00 ea.



- 68-13517 68-72 LH filler .....\$ 15.00 ea.
- 68-13518 68-72 RH filler .....\$ 15.00 ea.

## FLOOR PAN REAR CROSS BRACE



- 68-13515 68-72 .....\$ 49.00 ea.

+ The following items require additional shipping and handling.



# CHEVROLET NOVA PARTS



Car Shop Inc. 739 North Batavia Orange, California 92868

## REAR FRAME RAILS



Full length. Black EDP primer.

- 62-13521+ 62-67 LH ..... \$ 239.00 ea.  
62-13522+ 62-67 RH ..... \$ 239.00 ea.



Full length. Black EDP primer.

- 68-13521+ 68-72 LH ..... \$ 275.00 ea.  
68-13522+ 68-72 RH ..... \$ 275.00 ea.

## REAR FRAME RAIL BRACES

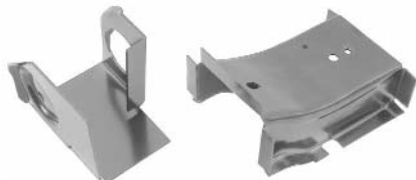

New Weld through primer.

- 62-13523 62-67 LH, front ..... \$ 49.00 pr.  
62-13524 62-67 RH, front ..... \$ 49.00 pr.



New Weld through primer.

- 62-13525 62-67 LH, rear ..... \$ 25.00 ea.  
62-13526 62-67 RH, rear ..... \$ 25.00 ea.



Black EDP primer.

- 68-13525 68-74 LH, rear ..... \$ 36.00 ea.  
68-13526 68-74 RH, rear ..... \$ 36.00 ea.

## FLOOR / TRUNK PAN STEEL PLUG



This is the oval shaped plug used on floor and trunk pans.

- 67-13511 62-74 With notch ..... \$ 3.00 ea.  
67-13512 62-74 Without notch ..... \$ 3.00 ea.

## GAS TANK KIT



Includes: Gas tank, fuel sender, fuel sender gasket, fuel sender locking ring, original style filler neck hose with GM markings, hose clamps, gas tank straps and strap bolts.

- 62-13540+ 62-65 5/16", 30 OHM ..... \$ 205.00 kit  
62-13541+ 62-65 3/8", 30 OHM ..... \$ 205.00 kit  
66-13542+ 66 5/16", 90 OHM ..... \$ 205.00 kit  
66-13543+ 66 3/8", 90 OHM ..... \$ 205.00 kit



Includes: Gas tank, fuel sender, fuel sender gasket, fuel sender locking ring, original style filler neck hose with GM markings, hose clamps, gas tank straps and strap bolts.

- 67-13542+ 67 5/16", 90 OHM ..... \$ 204.00 kit  
67-13543+ 67 3/8", 90 OHM ..... \$ 204.00 kit



Includes: Gas tank, fuel sender, fuel sender gasket, fuel sender locking ring, anti-squeek insulation kit, gas tank straps and strap bolts.

- 68-13544+ 68-69 5/16" ..... \$ 204.00 kit  
68-13545+ 68-69 3/8" ..... \$ 204.00 kit  
70-13544+ 70-72 5/16", w/o E.E.C. .... \$ 204.00 kit  
70-13545+ 70-72 3/8", w/o E.E.C. .... \$ 204.00 kit  
70-13546+ 70-72 5/16", with E.E.C. .... \$ 204.00 kit  
70-13547+ 70-72 3/8", with E.E.C. .... \$ 204.00 kit

## GAS TANKS



All except Station wagon.

- 62-13601+ 62-67 ..... \$ 117.00 ea.



- 68-13601+ 68-69 ..... \$ 117.00 ea.  
70-13601+ 70-72 w/o E.E.C. .... \$ 117.00 ea.  
71-13601+ 71-72 with E.E.C. .... \$ 119.00 ea.

## GAS TANK INSULATION KIT



Gas tank anti-squeek insulation kit.

- 67-13609 68-72 5-pc. .... \$ 19.00 kit



+ The following items require additional shipping and handling.

Fax Order 1-714-771-0407 • Toll Free 1-800-235-2470 • www.TruckandCarShop.com • 2014 Catalog



# CHEVROLET NOVA PARTS

Car Shop Inc. 739 North Batavia Orange, California 92868

## GAS TANK MOUNTING STRAP



62-13610 62-67 .....\$ 29.00 pr.



68-13611 68-72 .....\$ 29.00 pr.

73-13612 73-75 .....\$ 30.00 pr.

## GAS TANK STRAP BOLT KIT



Original style.

62-13612 62-66 .....\$ 11.00 kit



Original style, with correct black phosphate finish.

67-136121 67 10 pieces .....\$ 9.00 kit



Original style, with correct black phosphate finish.

68-13612 68-72 12 pieces .....\$ 9.00 kit

## GAS FILLER NECK



1962-1967 filler necks include gasket.

62-13613 62-64 .....\$ 76.00 ea.

65-13613 65-67 .....\$ 76.00 ea.

## GAS FILLER NECK MOUNTING BOLTS



62-13614 62-67 3 pieces .....\$ 2.50 kit

## GAS FILLER NECK TO BODY SEAL



62-13615 62-67 .....\$ 4.00 ea.

## FILLER NECK HOSE



62-13616 62-67 with clamps .....\$ 18.00 ea.

## GAS CAPS



62-13618 62-64 chrome .....\$ 16.00 ea.

65-13618 65-67 chrome .....\$ 16.00 ea.

62-13619 62-64 black primer .....\$ 20.00 ea.

65-13619 65-67 black primer .....\$ 20.00 ea.



65-13622 65-67 Bow tie, locking .....\$ 65.00 ea.



69-13701 68-70 Vented .....\$ 7.50 ea.

70-13702 70 All California cars .....\$ 5.00 ea.

71-13701 71-74 .....\$ 7.50 ea.

## GAS CAPS



69-13703 68-70 Locking gas cap .....\$ 13.00 ea.

71-13703 71-74 Locking gas cap .....\$ 17.00 ea.

## GAS TANK SENDING UNIT WIRE



Provides wiring for the fuel tank sending unit.

73-13704 73-75 .....\$ 17.00 ea.

## GAS TANK VENT VALVE



68-103225 68-70 .....\$ 30.00 ea.

## GAS TANK SENDING UNIT FILTERS



Original GM

67-13713 All With 5/16" line .....\$ 17.00 ea.

67-13714 All With 3/8" line .....\$ 16.00 ea.

Import

67-137132 All With 5/16" line .....\$ 12.00 ea.

67-137142 All With 3/8" line .....\$ 12.00 ea.

## GAS TANK SENDING UNIT LOCK RING



67-13711 67-74 .....\$ 2.00 ea.

## GAS TANK SENDING UNIT GASKET



67-13712 62-74 .....\$ 1.00 ea.

# CHEVROLET NOVA PARTS



Car Shop Inc. 739 North Batavia Orange, California 92868

## GAS TANK SENDING UNIT LOCK RING TOOL



Fuel tank sending unit lock ring installation & removal tool.  
67-137111 62-74 .....\$ 13.00 ea.

## GAS TANK SENDING UNITS



Includes gasket.  
62-13705 62-65 5/16", 30 OHM .....\$ 35.00 ea.  
62-13706 62-65 3/8", 30 OHM .....\$ 35.00 ea.



Includes gasket.  
66-13705 66-67 5/16", 90 OHM .....\$ 35.00 ea.  
66-13706 66-67 3/8", 90 OHM .....\$ 35.00 ea.



Includes gasket.  
67-13705 68-72 5/16" .....\$ 35.00 ea.  
67-13706 68-72 3/8" .....\$ 35.00 ea.  
69-13707 69-72 3/8" 2 lines .....\$ 35.00 ea.

## FUEL SENDER FLOAT



58-10922 62-67 .....\$ 6.00 ea.

## REAR LICENSE BRACKET / GAS TANK DOOR



69-13715 68-72 *Reproduction* .....\$ 22.00 ea.  
69-13716 68-72 *GM* .....\$ 49.00 ea.

## ACCELERATOR PEDAL PADS



64-04408 62-67 .....\$ 14.00 ea.



67-13801 68-74 .....\$ 4.00 ea.

## ACCELERATOR PEDAL TRIM PLATES



67-13803 68-74 .....\$ 4.00 ea.

## GAS PEDAL PIVOT STUD



58-04411 62-67 .....\$ 3.00 ea.

## GAS PEDAL TENSION SPRING



67-13806 68-79 *Exact reproduction* .....\$ 3.75 ea.

## GAS PEDAL TO ROD PIN



67-13807 68-74 .....\$ 2.50 ea.

## ACCELERATOR RODS



62-08714 64 *V8 w/ 4BBL, Includes grommets & return spring* .....\$ 29.00 kit



67-13808 65-69 *S/B, with quadrajat* .....\$ 29.00 ea.



67-13809 *S/B, with high rise intake manifolds* .....\$ 28.00 ea.



67-13810 68-72 *B/B, with quadrajat* .....\$ 27.00 ea.



67-13811 68-72 *B/B, with Holley* .....\$ 28.00 ea.



67-13812 62-79 *universal, adjusts 12" to 14"* .....\$ 12.00 ea.

\* The following items require additional shipping and handling.

Fax Order 1-714-771-0407 • Toll Free 1-800-235-2470 • [www.TruckandCarShop.com](http://www.TruckandCarShop.com) • 2014 Catalog



# CHEVROLET NOVA PARTS

Car Shop Inc. 739 North Batavia Orange, California 92868

## THROTTLE ARM



62-13813 62-67 V8 .....\$ 38.00 ea.



For use with accelerator rod, not a cable.  
67-13813 68-72 V8 .....\$ 16.00 ea.

## THROTTLE ARM PINCH BOLT KIT



Original headmark, 1/4-20 x 1" bolt with washers and nut.  
67-13815 62-70 V8 .....\$ 3.00 kit

## GAS PEDAL ROD



Mounts inside the car through the firewall. Gas pedal mounts to this part.  
For use with accelerator rod, not a cable.  
67-13816 68-74 V8 .....\$ 27.00 ea.



For use with accelerator cable.  
68-13816 68-74 .....\$ 42.00 ea.

## GAS PEDAL ROD TO FIREWALL BUSHINGS



Fits in metal firewall support.  
67-13904 62-67 2 per car .....\$ 1.50 ea.

## GAS PEDAL ROD TO FIREWALL SUPPORT



67-13902 68-74 .....\$ 16.00 ea.

## GAS PEDAL SUPPORT & THROTTLE ARM BOLT KIT



Includes support to firewall bolts & throttle arm pinch bolt.  
62-139013 62-67 6 pieces .....\$ 4.00 kit



Includes support to firewall bolts & throttle arm pinch bolt.  
67-139013 68-74 6 pieces .....\$ 4.00 kit

## ACCELERATOR ROD GROMMET AND SLEEVE



This is the grommet and sleeve that fits into the carb throttle control arm.  
67-13907 62-79 Grommet and sleeve ...\$ 3.00 ea.

## ACCELERATOR ROD SWIVEL KIT



67-13908 62-72 Fine thread, 6 pcs. ...\$ 8.00 kit

## GAS PEDAL & LINKAGE KIT



For use with accelerator cable.  
67-139051 68-74 cable style .....\$ 55.00 kit



For use with accelerator rod, not a cable.  
67-13906 68-74 V8 .....\$ 53.00 kit

## CABLE BALL STUDS



1/4-20, 5/16 hex, .22" ball. Powerglide kickdown.  
67-139081 69-72 .....\$ 4.00 ea.



1/4-20, 5/16 hex, .25" ball. Accelerator cable.  
67-139082 68-70 .....\$ 5.00 ea.

5/16-18, 3/8 hex, .25" ball. Accelerator cable.  
67-139083 71-87 .....\$ 5.00 ea.

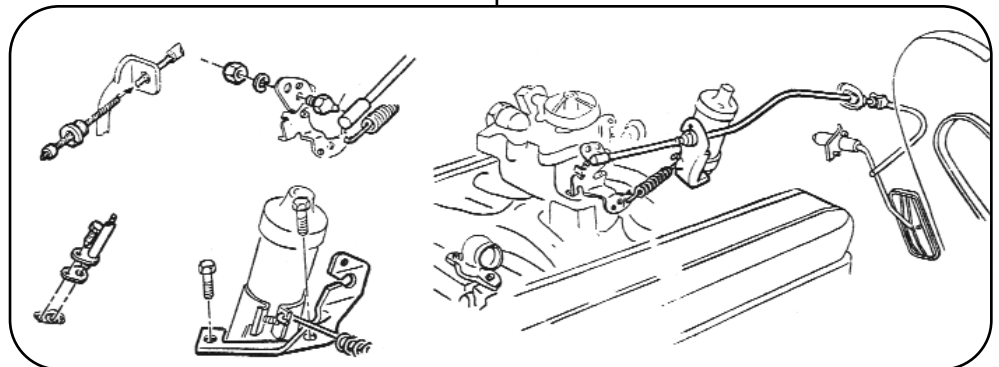

# CHEVROLET NOVA PARTS



Car Shop Inc. 739 North Batavia Orange, California 92868

## THROTTLE CABLES



Runs from the pedal to the carb linkage.

- 67-13909 68-72 6-cylinder .....\$ 21.00 ea.
- 70-139095 70-72 V8 4BBL, repro. ....\$ 34.00 ea.
- 70-13909 70-72 V8 4BBL, N.O.S. ....\$ 60.00 ea.

## THROTTLE CABLE TO PEDAL RETAINER



- 67-139092 67-74 .....\$ 4.00 ea.

## THROTTLE CABLE TO FIREWALL BOLT



- 68-13840 68-71 .....\$ 1.25 ea.

## THROTTLE CABLE BRACKET



Mounts to left rear carb stud

- 70-139104 69-71 BB with Q-Jet .....\$ 19.00 ea.



- 70-139105 70-72 BB with Holley .....\$ 15.00 ea.

## THROTTLE RETURN SPRING



- 67-13911 67-68 S/B, 4 BBL .....\$ 7.50 ea.
- 67-13912 67-68 302, 396, 427 .....\$ 7.50 ea.
- 69-13913 69 S/B .....\$ 7.50 ea.

## UNIVERSAL THROTTLE RETURN SPRINGS



- 67-13914 Universal Inner 6" to 10" reach . \$ 2.50 ea.
- 67-13915 Universal Outer 6" to 10" reach . \$ 2.50 ea.

## THROTTLE RETURN SPRING BRACKETS



- 67-13916 Universal bracket, chrome .....\$ 4.00 ea.



Universal bracket, stainless steel. Originally used on corvettes.

- 67-13917 S/B .....\$ 8.00 ea.
- 67-13918 B/B .....\$ 10.00 ea.



Original style, fits small block with Quadrajet carburetor.

- 68-139171 68-70 S/B with Q-jet .....\$ 10.00 ea.

## ACCELERATOR CABLE BRACKET & RETURN SPRING KITS



- 67-13919 Bracket with dual springs chrome .....\$ 7.00 kit



Accelerator cable bracket & return spring kit, chrome. For use with Holley carburetors.

- 67-13920 universal, Holley .....\$ 32.00 kit



Accelerator cable & TH350 kickdown bracket kit.

- 67-139201 universal, chrome .....\$ 17.00 kit

• CAR SHOP • BEST QUALITY! •  
• BEST PRICE! •

## PEDAL PAD & TRIM PLATE KITS

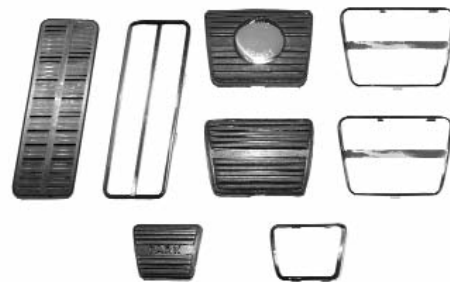

Kits include plastic gas pedal with trim, brake & clutch pedal pads with trim, and parking brake pedal pad with trim.

- 67-13931 68 MT with disc .....\$ 39.00 kit
- 69-13933 69-74 MT with disc .....\$ 39.00 kit

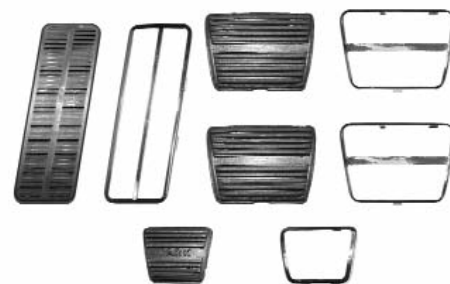

- 67-13932 68 MT without disc .....\$ 36.00 kit
- 69-13934 69-74 MT without disc .....\$ 36.00 kit

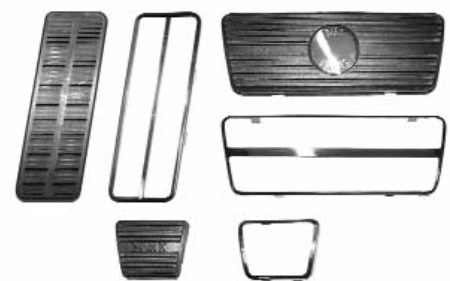

Kits include plastic gas pedal with trim, brake pedal pad with trim, and parking brake pedal pad with trim.

- 67-13935 68 AT with disc .....\$ 30.00 kit
- 69-13937 69-74 AT with disc .....\$ 29.00 kit



- 67-13936 68 AT without disc .....\$ 28.00 kit
- 69-13938 69-74 AT without disc .....\$ 27.00 kit

+ The following items require additional shipping and handling.

Fax Order 1-714-771-0407 • Toll Free 1-800-235-2470 • [www.TruckandCarShop.com](http://www.TruckandCarShop.com) • 2014 Catalog



# CHEVROLET NOVA PARTS

Car Shop Inc. 739 North Batavia Orange, California 92868

## AUTOMATIC BRAKE PEDAL PADS

58-04415 62-67 auto trans. w/o power ...\$ 6.00 ea.

58-04416 62-67 auto trans. with power ...\$ 6.00 ea.

67-14001 68-79 .....\$ 5.00 ea.

67-14002 68-79 with disc brakes .....\$ 9.00 ea.

## MANUAL TRANSMISSION BRAKE PEDAL PADS

Standard pedal pad.  
58-04414 62-67 brake or clutch .....\$ 6.00 ea.

Horizontal rib design pedal pad.  
62-14004 62-67 without power .....\$ 6.00 ea.  
62-14005 62-67 with power .....\$ 6.00 ea.

67-14004 68-79 .....\$ 5.00 ea.  
67-14005 68-79 with disc .....\$ 9.00 ea.

## AUTOMATIC BRAKE PEDAL TRIM PLATE

67-14003 68-79 .....\$ 6.50 ea.

## MANUAL TRANSMISSION PEDAL PAD TRIM PLATE

67-14006 68-79 brake or clutch .....\$ 6.00 ea.

## CLUTCH PEDAL PADS

Standard pedal pad.  
58-04414 62-67 .....\$ 6.00 ea.

Horizontal rib design pedal pad.  
62-14004 62-67 .....\$ 6.00 ea.

67-14004 68-79 .....\$ 5.00 ea.

## PARKING BRAKE PEDAL PADS

67-14010 68 reproduction .....\$ 4.00 ea.  
69-14011 69-77 .....\$ 4.00 ea.

## PARKING BRAKE PEDAL PAD TRIM PLATES

67-14012 68 .....\$ 5.00 ea.  
69-14013 69-77 .....\$ 4.00 ea.

## CLUTCH LINKAGE KIT

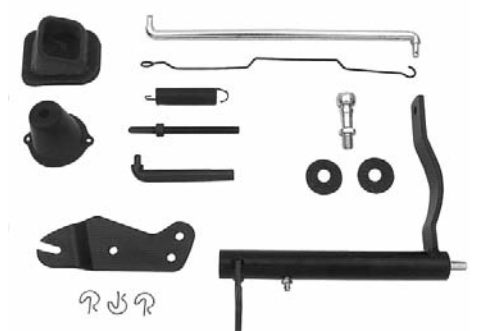

67-14014 68-74 S/B .....\$ 92.00 kit

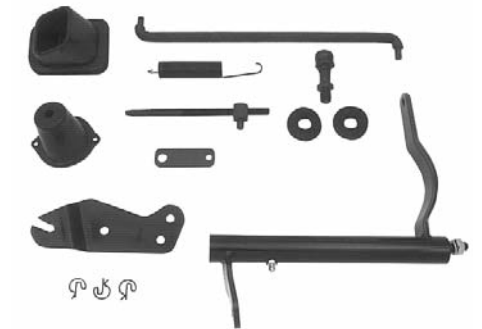

67-14015 68-72 B/B .....\$ 102.00 kit

## BRAKE PEDAL & HANGER ASSEMBLY



69-14031 69-74 Automatic .....\$ 239.00 ea.

## BRAKE PEDAL



67-14018 68-74 Automatic .....\$ 37.00 ea.

\* The following items require additional shipping and handling.

# CHEVROLET NOVA PARTS



Car Shop Inc. 739 North Batavia Orange, California 92868

## BRAKE PEDAL RETAINER PIN



62-14045 62-74 Automatic .....\$ 15.00 ea.

## BRAKE AND CLUTCH PEDALS



4 speed brake and clutch pedals with bushings.

62-14019 62-65 4-speed .....\$ 92.00 pr.  
66-14019 66-67 4-speed .....\$ 92.00 pr.



4 speed brake and clutch pedals with bushings.

67-14019 68 4-speed .....\$ 64.00 pr.  
69-14020 69-74 4-speed .....\$ 62.00 pr.

## BRAKE & CLUTCH PEDAL SUPPORT



69-14041 69-74 .....\$ CALL ea.

## BRAKE/CLUTCH PEDAL RETAINER, BUMPER & BUSHING

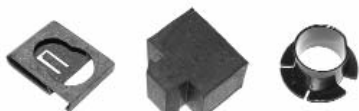

67-14101 62-79 Retainer .....\$ 3.00 ea.  
67-14102 62-79 Bumper .....\$ 4.00 ea.  
67-14103 62-79 Bushing .....\$ 1.50 ea.

## LOCK WASHER



67-14104 62-79 .....\$ .25 ea.

## BELLCRANK BALL STUD FELT GASKET SEAL



67-14105 62-79 .....\$ 3.50 pr.

## BELLCRANK PLASTIC SEAT & CLIP KIT



67-14126 62-79 Bellcrank ball stud plastic seat and retaining clip kit . . . \$ 5.00 kit

## BELLCRANK BALL STUD



Frame side bellcrank ball stud.

67-14108 62-72 .....\$ 10.00 ea.  
70-14109 73-79 .....\$ 12.00 ea.

## CLUTCH RETURN SPRING



67-14110 62-74 S/B .....\$ 5.00 ea.  
67-14111 68-72 B/B .....\$ 5.00 ea.

## CLUTCH RETURN SPRING EXTENSION

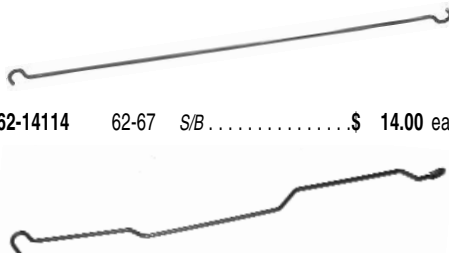

62-14114 62-67 S/B .....\$ 14.00 ea.

67-14114 68-74 S/B .....\$ 5.00 ea.



67-14115 68-72 B/B .....\$ 7.00 ea.

## UNIVERSAL CLUTCH RETURN SPRING



67-14116 Cut to fit .....\$ 4.00 ea.

## CLUTCH FORK LOWER PUSH ROD



62-14117 62-67 S/B .....\$ 29.00 ea.



67-14117 68-79 S/B, 2 piece .....\$ 14.00 ea.



67-14119 68-72 B/B .....\$ 15.00 ea.

## LOWER PUSH ROD NUT



67-14120 68-79 .....\$ .25 ea.

## LOWER PUSH ROD SWIVEL



67-14122 68-72 B/B, GM .....\$ 14.00 ea.

## CLUTCH BELLCRANK



62-14123 62-67 S/B .....\$ 47.00 ea.



67-14123 68-72 S/B .....\$ 35.00 ea.  
67-14124 68-72 B/B .....\$ 36.00 ea.

## CLUTCH BELLCRANK GREASE FITTING



62-14135 62-72 all .....\$ 1.50 ea.

+ The following items require additional shipping and handling.

Fax Order 1-714-771-0407 • Toll Free 1-800-235-2470 • [www.TruckandCarShop.com](http://www.TruckandCarShop.com) • 2014 Catalog



# CHEVROLET NOVA PARTS

Car Shop Inc. 739 North Batavia Orange, California 92868

## PUSH ROD CLIP



67-14127 62-79 .....\$ 1.00 ea.

## CLUTCH BELLCRANK PUSH ROD



62-14201 62-67 S/B .....\$ 29.00 ea.



67-14201 68-74 S/B .....\$ 12.00 ea.  
68-72 S/B

## CLUTCH PEDAL PUSHROD SEAL SCREW KIT



67-14130 68-74 .....\$ 1.50 pr.

## FIREWALL CLUTCH ROD BOOT



Boot seals around clutch rod and fits against the firewall, includes retainer.  
62-14203 62-67 .....\$ 28.00 ea.



Boot seals around clutch rod and fits against the firewall.  
67-14203 67-74 .....\$ 8.00 ea.



70-14204 75-79 .....\$ 13.00 ea.

## FIREWALL CLUTCH ROD HOLE COVER & SEAL



Used on factory automatic equipped Novas.  
67-14205 68-79 .....\$ 16.00 ea.

## BELLCRANK BALL STUD TO ENGINE BRACKET



New reproduction high performance 11" style bellhousing.  
67-142055 64-79 .....\$ 175.00 ea.  
67-142056 64-79 Heavy Duty .....\$ 249.00 ea.

## CLUTCH FORK



62-14206 62-67 .....\$ 41.00 ea.



67-142061 68-74 reproduction .....\$ 46.00 ea.  
67-14206 68-74 GM .....\$ 90.00 ea.

## CLUTCH FORK THROWOUT BEARING SPRING



Clutch Fork throwout bearing repair spring and rivet.  
67-14208 62-79 All .....\$ 19.00 ea.

## BELLCRANK BALL STUD



Engine side bellcrank ball stud.  
67-14209 62-79 reproduction .....\$ 10.00 ea.  
67-14210 62-79 GM .....\$ 18.00 ea.

## BELLCRANK BALL STUD TO ENGINE BRACKET



Engine side bracket to mount the bellcrank ball stud.  
62-142091 62-67 V8 .....\$ 22.00 ea.

## CLUTCH RELEASE FORK STUD



67-14211 62-79 reproduction .....\$ 11.00 ea.  
67-142111 62-79 GM .....\$ 15.00 ea.

## FRAME SIDE PIVOT BALL BRACKET



62-14212 62-67 V8 .....\$ 16.00 ea.



67-14212 68-74 .....\$ 14.00 ea.

## CLUTCH FORK BOOT



Seals the fork where it enters the bellhousing.  
62-14214 62-67 .....\$ 9.00 ea.  
67-14214 68-79 Original GM .....\$ 18.00 ea.  
67-142141 68-79 reproduction .....\$ 8.00 ea.

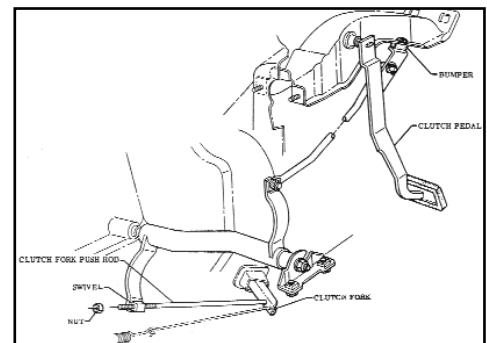



# CHEVROLET NOVA PARTS



Car Shop Inc. 739 North Batavia Orange, California 92868

## HEAVY DUTY ENGINE MOUNTING BRACKETS



Frame side. Stronger than stamped originals, with hardware.  
**62-142152** 62-67 S/B, LH & RH .....\$ 77.00 pr.

## ENGINE MOUNTING BRACKETS



Frame side. Original stamped style brackets.  
**66-14216** 66-67 6-cyl, LH & RH .....\$ 68.00 pr.  
**62-14215** 62-67 S/B, LH & RH .....\$ 75.00 pr.



These are the brackets that mount to the frame.  
**67-14215** 68 S/B, LH .....\$ 16.00 ea.  
**67-14216** 68 S/B, RH .....\$ 16.00 ea.



**67-14217** 68 B/B, LH and RH .....\$ 55.00 pr.



**69-14218** 69-72 S/B, LH and RH .....\$ 39.00 pr.



**69-14219** 69-72 B/B, LH and RH .....\$ 55.00 pr.

## MOTOR MOUNTS



These are the mounts that bolt to the engine. Fits LH or RH.  
**67-14301** 62-68 S/B, standard duty .....\$ 8.00 ea.



**67-14302** 62-68 S/B or B/B, heavy duty .....\$ 12.00 ea.



**69-14303** 69-72 S/B or B/B .....\$ 16.00 ea.

## L.S. ENGINE CONVERSION MOUNTS



For LS conversions.  
**67-143065** 62-74 V8 .....\$ 79.00 pr.

## MOTOR MOUNT TO BLOCK BOLT KIT



"Anchor" headmark, indented head with captured washers, zinc.  
**67-14306** 62-72 6 pieces .....\$ 8.00 set



Phosphate, (black-gray).  
**67-143061** 67-72 6 pieces .....\$ 9.00 set

## ENGINE MOUNTING BRACKET BOLT KIT



**62-143051** 62-67 V8, 12 pieces .....\$ 9.00 kit



**67-143051** 68-72 21 pieces .....\$ 6.00 kit

## MOTOR MOUNT BOLT KIT



Original "F" headmark, (2) 7/16-20 x 3-3/4" bolts, (4) washers and (2) lock nuts. Motor mount to frame mount.  
**67-14305** 62-68 V8 .....\$ 10.00 set



Motor mount to frame mount bolt kit. "A" headmark.  
**69-14305** 69-72 V8 .....\$ 12.00 kit

## ENGINE AND TRANSMISSION MOUNT KIT

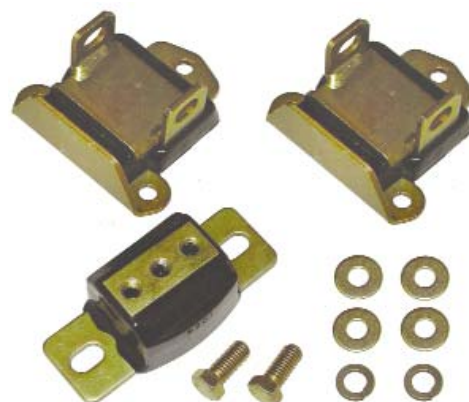

High performance urethane components.  
**67-14307** 62-68 2 5/8" mount spacing ..\$ 119.00 kit  
**69-14308** 69-72 2 3/8" mount spacing ..\$ 129.00 kit

\* The following items require additional shipping and handling.

Fax Order 1-714-771-0407 • Toll Free 1-800-235-2470 • [www.TruckandCarShop.com](http://www.TruckandCarShop.com) • 2014 Catalog



# CHEVROLET NOVA PARTS

Car Shop Inc. 739 North Batavia Orange, California 92868

## HEATER BOX DELETE PLATES



67-14315 68-79 without AC .....\$ 154.00 pr.



67-143151 68-79 with AC .....\$ 154.00 pr.

## HEATER CORES



62-14309 62-67 6-cyl. or V8 .....\$ 68.00 ea.



67-14310 68 B/B without A/C .....\$ 82.00 ea.  
67-14311 68 All with A/C .....\$ 84.00 ea.



69-14312 69-79 S/B without A/C .....\$ 50.00 ea.  
69-14313 69-72 B/B without A/C .....\$ 89.00 ea.



69-14314 69-74 All with A/C .....\$ 64.00 ea.

## HEATER CORE BRACKET SET



67-143155 68-72 B/B .....\$ 30.00 set

## SB HEATER CORE TUBE TO FIREWALL SEAL

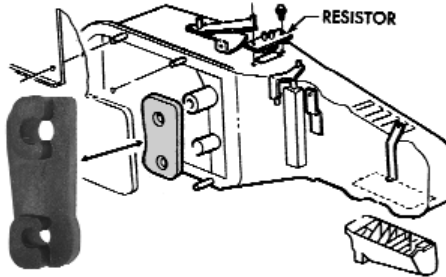

Correct molded rubber heater core tube seal.  
67-143193 68-74 SB without A/C .....\$ 12.00 ea.

## HEATER TUBE BLOCK OFF SEAL



Big block heater tube block off seal, without AC.  
67-143191 68-70 replacement .....\$ 4.00 ea.  
67-143195 68-70 correct, molded .....\$ 20.00 ea.

## HEATER CORE PIPE GROMMET



67-14320 68-71 All with A/C .....\$ 15.00 ea.

## HEATER BOX TO FIREWALL FASTENER KIT



Includes fasteners & mastic sealer washers.  
67-143161 68-72 .....\$ 3.00 kit

## HEATER BOX SEAL KITS

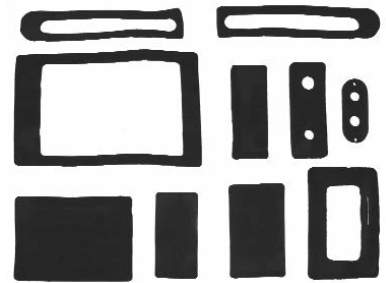

67-14319 68-74 Without A/C .....\$ 18.00 kit

## HEATER CORE BOX



Under dash. Without AC.  
67-14318 68-74 .....\$ 265.00 ea.

## HEATER BOX



Without A/C, engine side.  
67-14316 68-79 S/B, black .....\$ 30.00 ea.



Without A/C, engine side.  
67-143161 68-79 S/B, chrome .....\$ 79.00 ea.



67-14317 68-72 B/B .....\$ 48.00 ea.



Without A/C, engine side.  
67-143171 68-79 B/B, chrome .....\$ 89.00 ea.

# CHEVROLET NOVA PARTS



Car Shop Inc. 739 North Batavia Orange, California 92868

## BB HEATER TUBE TO BOX COVER PLATE



67-143192 69-72 BB without A/C .....\$ 20.00 ea.

## HEATER CONTROL VALVE



69-14321 69-70 With A/C .....\$ 34.00 ea.



71-14322 71-72 With A/C .....\$ 29.00 ea.

## A/C DELETE FIREWALL COVER



Our AC Delete cover makes removing your original AC system very easy and at the same time maintains the function of your original heater and defrost system.

68-14350 68-79 .....\$ 139.00 ea.

## A/C EVAPORATOR CASE/BOX

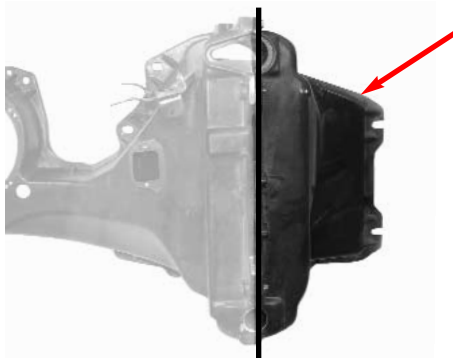

**Engine side** of the A/C heater box.

Big block inner box will not mount to small block outer box.

67-14401 68-73 S/B .....\$ 129.00 ea.

67-14402 68-72 B/B .....\$ 129.00 ea.

## A/C EVAPORATOR CORE

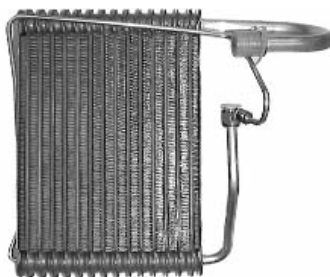

67-10647 66-67 S/B .....\$ 299.00 ea.

68-14404 68-73 S/B .....\$ 280.00 ea.

68-144041 68-72 B/B .....\$ 280.00 ea.

## A/C CONDENSERS



62-14405 62-66 .....\$ 275.00 ea.

67-14405 67-68 .....\$ 275.00 ea.

69-14405 69 .....\$ 275.00 ea.

70-14405 70-74 .....\$ 275.00 ea.

## A/C CONDENSER MOUNTING BRACKETS



67-14408 68-69 .....\$ 22.00 pr.

## A/C EVAPORATOR CASE DRAIN HOSE



67-14403 68-72 All with A/C .....\$ 10.00 ea.

## A/C EXPANSION VALVE



67-14409 68-73 AC Delco .....\$ 50.00 ea.

67-144092 68-73 reproduction .....\$ 27.00 ea.

## P.O.A. UPDATE KIT



Eliminates POA valve. Includes POA eliminator tube, pressure switch, wiring and instructions.

67-14410 66-73 R-12 .....\$ 99.00 kit

67-14411 66-73 R-134A .....\$ 99.00 kit

## A/C O-RING SEAL KIT



67-14412 62-76 R-134A or R-12 .....\$ 8.00 kit

## A/C VACUUM RESERVOIR TANK



Plastic replacement tank.

67-14412 67-74 All .....\$ 20.00 ea.

## A/C COMPRESSORS



Rebuilt AC Delco axial style compressor.

67-14413 62-76 all, rebuilt .....\$ 289.00 ea.



Aluminum high efficiency axial style compressor.

67-144132 62-76 all, new .....\$ 389.00 ea.

† The following items require additional shipping and handling.

Fax Order 1-714-771-0407 • Toll Free 1-800-235-2470 • [www.TruckandCarShop.com](http://www.TruckandCarShop.com) • 2014 Catalog



# CHEVROLET NOVA PARTS

Car Shop Inc. 739 North Batavia Orange, California 92868

## A/C CONDENSER FITTING



67-14414 67-68 replacement fitting . . . . \$ 14.00 ea.

## A/C CONDENSER MUFFLER



67-14416 67-68 S/B . . . . . \$ 85.00 ea.

## A/C CONDENSER MUFFLER ASSEMBLY



69-14419 69-70 . . . . . \$ 169.00 ea.  
71-14419 71-72 . . . . . \$ 169.00 ea.

## A/C HOSE TO INNER FENDER GROMMET



67-144032 68 All with A/C . . . . . \$ 28.00 ea.



## SMALL BLOCK A/C BRACKETS



67-14501 64-68 Front brace, S/B . . . . \$ 23.00 ea.



67-14502 64-68 Rear brace, S/B . . . . \$ 20.00 ea.



67-14503 64-68 Front lower bracket, S/B . . . . . \$ 58.00 ea.



67-14504 64-68 Front brace, S/B . . . . . \$ 52.00 ea.



67-14505 64-68 Rear pivot bracket, on compressor, S/B . . . \$ 17.00 ea.



67-145051 64-68 Lower side support bracket, on exhaust, S/B . . . . \$ 69.00 ea.



67-145052 64-68 rear shim, S/B . . . . \$ 6.00 ea.

## SMALL BLOCK A/C BRACKET BOLT KIT



67-145053 64-68 AC bracket hardware kit S/B . . . . . \$ 19.00 kit

## SMALL BLOCK A/C BRACKET KIT

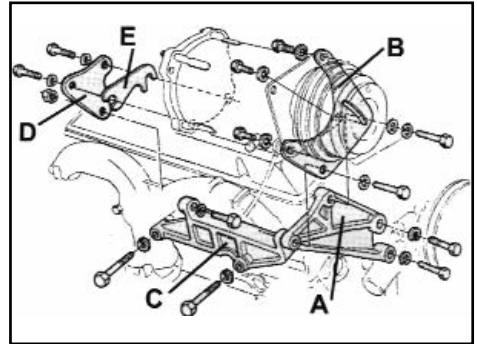

Includes: 1 front brace, 1 front bracket, 1 lower support, 1 rear bracket, 1 rear shim, hardware.

67-14506 64-68 S/B . . . . . \$ 165.00 kit

## SMALL BLOCK A/C BRACKETS



69-145061 69-74 Front brace, S/B . . . . \$ 20.00 ea.



69-145062 69-74 rear bracket support S/B . . . . . \$ 30.00 ea.

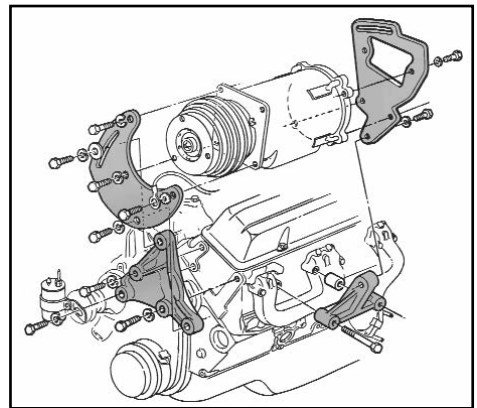

+ The following items require additional shipping and handling.

# CHEVROLET NOVA PARTS



Car Shop Inc. 739 North Batavia Orange, California 92868

## BIG BLOCK A/C BRACKETS

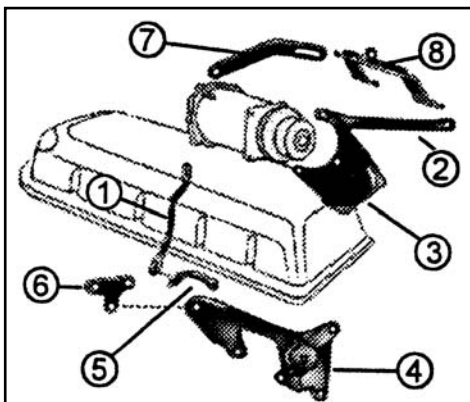

67-14507 68 Front compressor brace, B/B, #2 .....\$ 23.00 ea.

67-14508 68 Rear compressor brace, B/B, #7 .....\$ 23.00 ea.

67-14509 68 Upper support, on intake, B/B, cast, #8 .....\$ 49.00 ea.

67-14510 68 Front adjuster, B/B, #3 .....\$ 64.00 ea.

67-14511 68 Lower support, B/B, cast, #4 .....\$ 79.00 ea.

67-14512 68 Rear pivot bracket, B/B, #6 .....\$ 17.00 ea.

## BIG BLOCK A/C BRACKETS

67-14513 68 Rear support bar bracket, B/B, #5 .....\$ 16.00 ea.

67-14514 68 Rear support bar, B/B, #1 .....\$ 25.00 ea.

69-145151 69-70<sup>e</sup> front B/B .....\$ 77.00 ea.  
Cast-iron bracket mounts to front of head for adjuster plate mount. Bracket replaces GM #3940948

70-145152 70-72 front B/B .....\$ 77.00 ea.  
Bracket replaces GM #3969917

69-145153 69-70<sup>e</sup> front adjuster B/B .....\$ 44.00 ea.  
Stamped-steel plate mounts to A/C compressor and cast-iron support bracket. Bracket replaces GM #3940949

70-145154 70-72 front adjuster B/B .....\$ 24.00 ea.  
Stamped-steel plate mounts to A/C compressor and cast-iron support bracket. Bracket replaces GM #3969916.

69-145155 69-70<sup>e</sup> rear adjuster B/B .....\$ 44.00 ea.  
Stamped-steel adjuster bracket attaches to intake manifold bolts and goes over valve cover for rear compressor adjustment. Bracket replaces GM #3940947

## BIG BLOCK A/C BRACKETS

70-145156 70-72 inboard support B/B ...\$ 24.00 ea.  
Stamped-steel, inboard support bracket attaches to intake manifold bolt and goes over valve cover for side compressor support. Bracket replaces GM #3969910.

69-145157 69-70<sup>e</sup> rear plate B/B .....\$ 21.00 ea.  
Triangular, stamped-steel plate attaches compressor to lower support bracket. Bracket replaces GM #3932493

70-145158 70-72 rear plate B/B .....\$ 40.00 ea.  
Stamped-steel plate attaches compressor to lower support bracket. Bracket replaces GM #3969911.

69-145159 69-71 lower B/B .....\$ 44.00 ea.  
Cast-iron lower support attaches compressor triangular plate to cylinder head. Support replaces GM #3969912

72-145160 72 lower B/B .....\$ 44.00 ea.  
Cast-iron lower support attaches compressor rear plate to cylinder head. Support replaces GM #329227.

69-1451561 69-70<sup>e</sup> spacer B/B .....\$ 20.00 ea.  
Rear A/C adjuster spacer. Spacer replaces GM #3932437.

**• CAR SHOP • BEST QUALITY! •  
• BEST PRICE! •**

+ The following items require additional shipping and handling.

Fax Order 1-714-771-0407 • Toll Free 1-800-235-2470 • [www.TruckandCarShop.com](http://www.TruckandCarShop.com) • 2014 Catalog



# CHEVROLET NOVA PARTS

Car Shop Inc. 739 North Batavia Orange, California 92868

## A/C DRIER



62-090171 62-63 .....\$ 69.00 ea.



67-145151 64-67 reproduction .....\$ 18.00 ea.  
67-14515 64-67 AC Delco .....\$ 37.00 ea.



68-14516 68-73 AC Delco .....\$ 29.00 ea.

## HEATER BLOWER MOTOR TO FIREWALL SEAL



62-14517 62-65 .....\$ 12.00 pr.

## HEATER BLOWER MOTOR



67-14518 62-74 without A/C .....\$ 34.00 ea.  
68-77 with A/C



67-145182 62-74 without A/C, with fan ..\$ 47.00 ea.

## HEATER BLOWER MOTOR FAN



67-14520 62-74 .....\$ 27.00 ea.

## BLOWER MOTOR RELAY



67-14521 62-68 All .....\$ 12.00 ea.  
69-14522 69-74 All .....\$ 21.00 ea.

## A/C THERMAL LIMITER



Connects to AC harness near rear of compressor.  
72-14530 72-74 .....\$ 14.00 ea.

## BLOWER MOTOR RESISTOR ASSEMBLY

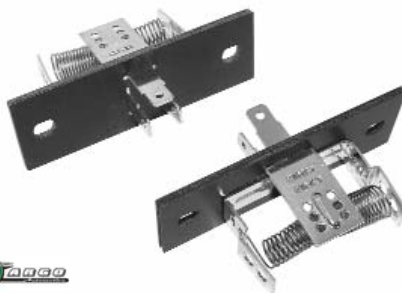

67-14601 62-79 without A/C .....\$ 13.00 ea.



67-14602 68 with A/C .....\$ 16.00 ea.  
68-14603 67-70 with Acc. A/C .....\$ 19.00 ea.

## KEY BLANKS



Original style keys

|          |       |                 |         |      |     |
|----------|-------|-----------------|---------|------|-----|
| 58-06924 | 62-66 | Ignition/doors  | .....\$ | 3.50 | ea. |
| 58-06925 | 62-66 | Trunk/glove box | .....\$ | 3.50 | ea. |
| 67-14605 | 67    | A-Octagon       | .....\$ | 3.50 | ea. |
| 67-14606 | 67    | B-Pear head     | .....\$ | 3.50 | ea. |
| 68-14607 | 68    | C-Octagon       | .....\$ | 3.50 | ea. |
| 68-14608 | 68    | D-Pear head     | .....\$ | 3.50 | ea. |



|          |       |          |         |      |     |
|----------|-------|----------|---------|------|-----|
| 69-14601 | 69-79 | A-square | .....\$ | 3.50 | ea. |
| 69-14602 | 69-79 | B-round  | .....\$ | 3.50 | ea. |
| 69-14603 | 69-79 | C-square | .....\$ | 3.50 | ea. |
| 69-14604 | 69-79 | D-round  | .....\$ | 3.50 | ea. |
| 69-14605 | 69-79 | E-square | .....\$ | 3.50 | ea. |
| 69-14606 | 69-79 | H-round  | .....\$ | 3.50 | ea. |
| 69-14607 | 69-79 | J-square | .....\$ | 3.50 | ea. |
| 69-14608 | 69-79 | K-round  | .....\$ | 3.50 | ea. |

## IGNITION LOCK WITH KEYS



Ignition switch cylinder lock with 2 keys.

|          |       |                |         |       |     |
|----------|-------|----------------|---------|-------|-----|
| 64-10710 | 62-64 | with "GM" keys | .....\$ | 11.00 | ea. |
| 65-10711 | 65    |                | .....\$ | 13.00 | ea. |



|          |       |         |       |     |
|----------|-------|---------|-------|-----|
| 67-14609 | 66-67 | .....\$ | 15.00 | ea. |
| 68-14610 | 68    | .....\$ | 18.00 | ea. |
| 69-14611 | 69-78 | .....\$ | 15.00 | ea. |

## DOOR LOCK SET WITH KEYS



|          |       |         |       |     |
|----------|-------|---------|-------|-----|
| 64-10719 | 62-66 | .....\$ | 24.00 | set |
| 67-14613 | 67-68 | .....\$ | 24.00 | set |
| 69-14614 | 69-79 | .....\$ | 16.00 | set |

# CHEVROLET NOVA PARTS



Car Shop Inc. 739 North Batavia Orange, California 92868

## DOOR LOCK GASKETS



67-14617 62-79 black .....\$ 1.50 ea.

## DOOR LOCK PAWL RETAINER



67-14618 62-79 .....\$ 1.00 ea.

## DOOR LOCK PAWL



62-14620 62-67 LH .....\$ 6.00 ea.  
 62-14621 62-67 RH .....\$ 6.00 ea.  
 68-14620 68-79 LH .....\$ 6.00 ea.  
 68-14621 68-79 RH .....\$ 6.00 ea.

## IGNITION AND DOOR LOCK SET



Includes: 1 ignition lock, and 2 door locks with 2 matched keys.

64-10730 62-64 .....\$ 44.00 set  
 65-10731 65 .....\$ 44.00 set  
 67-14624 66-67 .....\$ 30.00 set  
 68-14625 68 .....\$ 36.00 set  
 69-14626 69-78 .....\$ 30.00 set

## TRUNK LOCK WITH KEYS



67-14629 62-67 .....\$ 18.00 ea.  
 68-10740 68 .....\$ 17.00 ea.  
 69-06904 69-79 .....\$ 14.00 ea.

## GLOVE BOX LOCK



All come coded and are ready to be installed.

62-14712 62-65 .....\$ 24.00 ea.  
 67-14712 66-67 .....\$ 24.00 ea.  
 68-06737 68 .....\$ 22.00 set  
 69-14713 69-79 .....\$ 20.00 ea.

## GLOVE BOX LOCK RETAINER



62-14714 62-65 .....\$ 8.00 ea.

## GLOVE BOX AND TRUNK LOCK SET



Complete With Coded Keys. Includes 1 trunk lock, 1 glove box lock and 2 matched keys.

62-14715 62-65 .....\$ 35.00 set  
 67-14715 66-67 .....\$ 34.00 set



68-10809 68 .....\$ 38.00 set  
 68-10810 69-79 .....\$ 33.00 set

## GLOVE BOX, TRUNK AND DOOR LOCK SET



Complete With Coded Keys.

62-14720 62-65 .....\$ 49.00 set  
 67-14720 66-67 .....\$ 49.00 set  
 68-10823 68 .....\$ 54.00 set  
 69-10824 69-79 .....\$ 51.00 set

## COMPLETE LOCK SET



Includes ignition cylinder, glove box lock, door locks, door lock pawl retainers, trunk lock and keys.

62-14726 62-64 .....\$ 62.00 set  
 65-14726 65 .....\$ 62.00 set  
 67-14726 66-67 .....\$ 59.00 set  
 68-10830 68 .....\$ 63.00 set



69-10831 69-78 .....\$ 62.00 set

## TRUNK LOCK GASKET



67-14701 62-79 Molded rubber .....\$ 3.00 ea.

## TRUNK LOCK RETAINER



62-14704 62-65 original style .....\$ 12.00 ea.  
 66-14705 66-67 original style .....\$ 12.00 ea.



68-14705 68-72 original style .....\$ 12.00 ea.

+ The following items require additional shipping and handling.



# CHEVROLET NOVA PARTS

Car Shop Inc. 739 North Batavia Orange, California 92868

## LOCK RETAINER



67-14706 62-72 replacement style . . . . \$ 1.00 ea.

## TRUNK LOCK SPRING



67-14707 62-79 . . . . . \$ 2.00 ea.

## TRUNK LOCK SHAFT



67-14708 62-79 . . . . . \$ 2.00 ea.

## TRUNK LATCH MECHANISM



67-14710 62-72 . . . . . \$ 27.00 ea.  
70-14711 73-74 . . . . . \$ 35.00 ea.

## TRUNK LATCH CATCH



64-147111 64-70 . . . . . \$ 25.00 ea.

## TRUNK LATCH & CATCH BOLTS



1/4-20 x 5/8, 7/16 hex, with .75 toothed washer.  
67-147115 62-74 5 pieces . . . . . \$ 5.00 set

## TRUNK LID GUIDE PLATES



62-14719 62-65 . . . . . \$ 9.00 pr.

## WINDSHIELD WIPER SWITCH



Replaces GM# 01993541  
59-070311 62-64 Single speed . . . . . \$ 32.00 ea.



Replaces GM# 01993584  
62-14801 62-64 2 speed . . . . . \$ 35.00 ea.



Replaces GM# 01993680  
65-10833 65-66 Single speed with washers . . . . . \$ 33.00 ea.



Replaces GM# 01993679  
66-10835 65-66 2-speed with washers . . . . . \$ 33.00 ea.



Replaces GM# 01993395  
67-14801 67-68 All . . . . . \$ 33.00 ea.

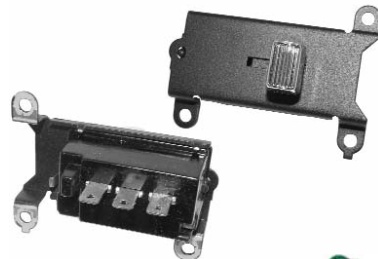

Replaces GM# 01993464  
69-14802 69-71 . . . . . \$ 25.00 ea.

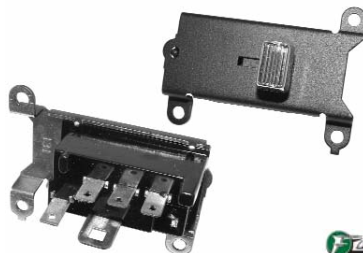

Replaces GM# 01994180  
72-108382 72-74 . . . . . \$ 33.00 ea.

## WINDSHIELD WIPER SWITCH RETAINING NUT



Replacement for some years.  
66-108385 62-68 . . . . . \$ 5.00 ea.

## WIPER SWITCH NUT TOOL



69-14805 62-65 . . . . . \$ 9.00 ea.  
68-72 . . . . . \$ 9.00 ea.  
66-14805 66-67 . . . . . \$ 9.00 ea.

## WINDSHIELD WIPER SWITCH KNOB



66-10841 65-66 . . . . . \$ 14.00 ea.



67-14806 67 . . . . . \$ 7.00 ea.



68-10901 68 . . . . . \$ 15.50 ea.  
69-14807 69-74 . . . . . \$ 3.50 ea.

## WINDSHIELD WASHER JAR CAPS



67-14814 62-74 Cap only, with letters . . . \$ 3.50 ea.  
67-148141 62-74 Cap only, without letters . \$ 3.00 ea.

## WASHER JAR FILTER



This is the small filter located on the end of the hose inside the jar.  
67-14815 62-74 . . . . . \$ 4.00 ea.



# CHEVROLET NOVA PARTS



Car Shop Inc. 739 North Batavia Orange, California 92868

## WINDSHIELD WASHER JARS



Includes: Jar, Cap, Filter and filter hose.

67-14810 62-70 .....\$ 11.00 kit



70-14811 71-74 .....\$ 16.00 kit

## WINDSHIELD WASHER JAR BRACKET BOLTS



62-148165 62-66 .....\$ 2.50 kit



67-148166 67 .....\$ 2.50 kit



67-148165 68-70 .....\$ 2.50 kit



71-148165 71-74 .....\$ 2.00 kit

## WINDSHIELD WASHER JAR BRACKET



62-14816 62-67 .....\$ 20.00 ea.



67-14816 68-70 .....\$ 7.00 ea.

## OPTIKLEEN BOTTLE KIT



Includes bottle, cap, label and mounting bracket.

67-14809 62-73 .....\$ 40.00 kit

## WINDSHIELD WASHER NOZZLES



62-14819 62-67 .....\$ 28.00 pr.

68-14820 68-74 .....\$ 28.00 pr.

## WASHER NOZZLE BOLT KIT



62-14825 62-66 .....\$ 1.75 pr.



67-148251 67 .....\$ 1.75 pr.



67-14825 68-72 .....\$ 1.50 pr.



70-14826 73-74 .....\$ 1.50 pr.

## WASHER PUMP REPAIR KIT



67-149031 63-79 .....\$ 14.00 kit

## WASHER FLUID PUMPS

New Tooling!  
Correct white  
colored pump



Must modify mounting hole to fit some wiper motors.

67-14901 63-74 with correct  
white pump fittings . . . \$ 34.00 ea.

## WINDSHIELD WASHER HOSE KIT



67-14904 62-74 .....\$ 18.00 kit

## WIPER MOTOR SEAL



67-14909 62-67 .....\$ 3.50 ea.

68-14910 68-69 .....\$ 3.50 ea.

+ The following items require additional shipping and handling.



# CHEVROLET NOVA PARTS

Car Shop Inc. 739 North Batavia Orange, California 92868

## WIPER MOTORS



- 67-14905 63-67 2 speed 3 terminal . . . \$ 172.00 ea.
- 67-14906 63-67 2 speed 4 terminal . . . \$ 180.00 ea.
- 68-14907 68-79 All . . . . . \$ 172.00 ea.

## WINDSHIELD WIPER MOTOR GROMMETS



- 67-14915 63-79 Grommets & bolts . . . . \$ 10.00 set

- 67-14916 63-79 Bolt only . . . . . \$ 1.75 ea.

## WIPER MOTOR ARM WITH BALL STUD



- 68-149081 68-74 . . . . . \$ 14.00 ea.

## WIPER TRANSMISSION ASSEMBLY



- 62-149101 62-67 . . . . . \$ 99.00 set

## WIPER TRANSMISSION BOLTS



- 10-24 x 1/2, 5/16 hex, with star washer.
- 67-149105 62-74 4 pieces . . . . . \$ 4.00 set

## WINDSHIELD WIPER SHAFT BULLETS



- Bullet style wiper shaft covers, chrome, universal.
- 67-149145 62-79 fits 5/8" shaft . . . . . \$ 12.00 pr.

## WIPER ARMS



- Straight tip mount, use with 15" straight tip mount wiper blades. Total length from center of mounting hole to blade tip is 20 3/4".
- 67-14912 62-67 LH & RH, 13" polished stainless . . . . \$ 33.00 pr.



- Straight tip mount. replacement for side post type. Use with 15" straight tip mount wiper blades # 67-14913. Total length from center of mounting hole to blade tip is 22 1/2".
- 67-14911 68-74 LH or RH, 14 1/2" polished stainless . . . . \$ 11.00 ea.

## WIPER BLADES



- Straight tip mount. 1968-74 replacements, use with straight tip wiper arm #67-14911.
- 67-14913 62-74 15", LH & RH polished stainless . . . . \$ 11.00 ea.



- Side post mount.
- 68-110021 68-72 16", LH or RH . . . . \$ 18.00 ea.



- 67-149142 62-67 Aero style, 15" LH & RH . . . . . \$ 54.00 pr.

**Showroom hours:**  
**TUESDAY - FRIDAY: 8:30AM to 4:30PM**  
**SATURDAY: 8:30AM to 3:30PM**  
**Phone order desk hours:**  
**MONDAY - FRIDAY: 8:30AM to 4:30PM**

## RADIATOR CAPS



- Correct RC-15 reproduction radiator cap, correct text & "AC" logo.
- 67-150021 63-72 15 lbs. . . . . \$ 29.00 ea.



- AC delco replacements, not stamped AC.
- 58-07419 62-64 13 lbs. . . . . \$ 11.00 ea.
  - 67-15002 63-73 15 lbs. . . . . \$ 14.00 ea.
  - 74-15003 74-75 . . . . . \$ 9.50 ea.

## RADIATOR OVERFLOW HOSE CLIP



- Mounts on the side of the radiator.
- 68-150051 68-74 . . . . . \$ 11.00 ea.

## RADIATOR OVERFLOW HOSE



- Reproduction of the original thin walled tubing.
- 67-15005 62-79 . . . . . \$ 2.00 ft.

## RADIATOR OVERFLOW JAR



- 73-15006 73-74 Jar . . . . . \$ 45.00 ea.

## RADIATOR OVERFLOW JAR CAPS



- 73-15009 73-75 Cap . . . . . \$ 7.00 ea.
- 78-15010 76-79 Cap . . . . . \$ 10.00 ea.

\* The following items require additional shipping and handling.

# CHEVROLET NOVA PARTS



Car Shop Inc. 739 North Batavia Orange, California 92868

## RADIATORS



New reproduction radiators are now available for all years of Novas. All feature new cores and tanks, not rebuilt. Radiators are built to your cars exact specifications depending on year, transmission type, A/C and engine size. No exchange required and all exceed OEM standards.

Radiators are shipped UPS OVERSIZED

- 62-14950+ 62-65 194, 230 A/T  
18 1/2" core (3 row) . . . \$ 324.00 ea.
- 62-14951+ 62-65 194, 230 M/T  
18 1/2" core (3 row) . . . \$ 324.00 ea.
- 64-14952+ 64-65 194, 230 A/T  
23" core (3 row) . . . . \$ 335.00 ea.
- 64-14953+ 64-65 194, 230 M/T  
23" core (3 row) . . . . \$ 335.00 ea.



- 64-14954+ 64-65 SB A/T  
23" core (3 row) . . . . \$ 335.00 ea.
- 64-14955+ 64-65 SB, M/T  
23" core (3 row) . . . . \$ 335.00 ea.
- 62-14956+ 62-65 SB A/T  
23" core (4 row) . . . . \$ 374.00 ea.
- 62-14957+ 62-65 SB, M/T  
23" core (4 row) . . . . \$ 374.00 ea.



With side facing brackets.

- 66-14958+ 66-67 194, 230 A/T  
23" core (3 row) . . . . \$ 335.00 ea.
- 66-14959+ 66-67 194, 230 M/T  
23" core (3 row) . . . . \$ 335.00 ea.

## RADIATORS



With side facing brackets.

- 66-14960+ 66-67 SB A/T  
23" core (3 row) . . . . \$ 335.00 ea.
- 66-14961+ 66-67 SB M/T  
23" core (3 row) . . . . \$ 335.00 ea.

With side facing brackets.

- 66-14962+ 66-67 SB A/T  
23" core (4 row) . . . . \$ 374.00 ea.
- 66-14963+ 66-67 SB M/T  
23" core (4 row) . . . . \$ 374.00 ea.



With recessed side brackets.

- 66-14964+ 66-67 SB Hi-Perf. A/T  
23" core (4 row) . . . . \$ 395.00 ea.
- 66-14965+ 66-67 SB Hi-Perf. M/T  
23" core (4 row) . . . . \$ 395.00 ea.

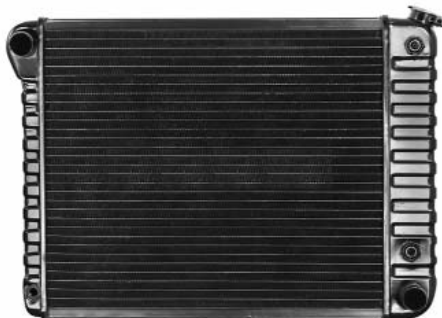

- 70-14925+ 68-71 SB, A/T  
20 3/4" core, (3 row) . . . \$ 329.00 ea.
- 70-14926+ 68-71 SB, M/T  
20 3/4" core, (3 row) . . . \$ 329.00 ea.
- 68-14970+ 68-71 SB, A/T  
20 3/4" core, (4 row) . . . \$ 359.00 ea.
- 68-14971+ 68-71 SB, M/T  
20 3/4" core, (4 row) . . . \$ 359.00 ea.

## RADIATORS

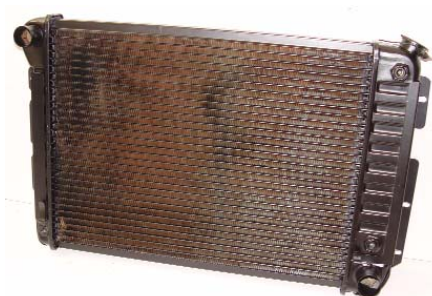

With side facing brackets.

- 68-14972+ 68-72 BB, A/T  
23" core, (4 row) . . . . \$ 385.00 ea.
- 68-14973+ 68-72 BB, M/T  
23" core, (4 row) . . . . \$ 385.00 ea.



- 72-14974+ 72-74 SB, A/T or MT  
23" core, (3 row) . . . . \$ 339.00 ea.
- 72-14975+ 72-74 SB, A/T or MT  
23" core, (4 row) . . . . \$ 385.00 ea.
- 72-14976+ 72-79 SB, A/T or MT  
20 3/4" core, (3 row) . . . \$ 329.00 ea.
- 72-14977+ 72-79 SB, A/T or MT  
20 3/4" core, (4 row) . . . \$ 369.00 ea.

## RADIATOR MOUNTING KIT



Radiator and center shroud bolt kit.

- 62-14940 62-67 . . . . . \$ 13.00 kit



Correct well nut & bolt kit.

- 67-14940 68-72 BB . . . . . \$ 5.00 kit

## RADIATOR PETCOCK

- 67-15001 All . . . . . \$ 4.00 ea.

+ The following items require additional shipping and handling.



# CHEVROLET NOVA PARTS

Car Shop Inc. 739 North Batavia Orange, California 92868

## RADIATOR OVERFLOW JAR KIT



Polished aluminum overflow jar with brackets & cap, universal.

- |          |         |               |     |
|----------|---------|---------------|-----|
| 67-15011 | 13 inch | .....\$ 39.00 | kit |
| 67-15012 | 15 inch | .....\$ 39.00 | kit |

## CHROME RADIATOR UPPER MOUNTING PANEL



- |          |       |                           |               |     |
|----------|-------|---------------------------|---------------|-----|
| 68-11108 | 68-79 | Fits 20 3/4" core, chrome | .....\$ 27.00 | ea. |
|----------|-------|---------------------------|---------------|-----|

## RADIATOR MOUNTING PADS



2 pads fit between the radiator and the core support and 2 pads fit between the radiator and the upper mounting panel. 4 req. 3-3/4" pad with 2-3/4" groove.

- |          |       |       |              |     |
|----------|-------|-------|--------------|-----|
| 70-15021 | 68-74 | 3 row | .....\$ 7.50 | ea. |
|----------|-------|-------|--------------|-----|



4-1/8" pad with 3-5/8" groove.

- |          |       |       |              |     |
|----------|-------|-------|--------------|-----|
| 70-15022 | 68-72 | 4 row | .....\$ 8.00 | ea. |
|----------|-------|-------|--------------|-----|



Kit Includes (4) 3-3/4" pads with 2-3/4" groove.

- |           |       |                 |               |     |
|-----------|-------|-----------------|---------------|-----|
| 68-111104 | 68-74 | 3 row, 4 pieces | .....\$ 15.00 | set |
|-----------|-------|-----------------|---------------|-----|

## RADIATOR SUPPORT BUSHING AND BOLT KIT



- |          |       |               |     |
|----------|-------|---------------|-----|
| 67-15016 | 68-74 | .....\$ 25.00 | kit |
|----------|-------|---------------|-----|

## RADIATOR SUPPORT



- |           |       |                |     |
|-----------|-------|----------------|-----|
| 62-15013+ | 62-64 | .....\$ 185.00 | ea. |
| 65-15013+ | 65    | .....\$ 185.00 | ea. |



- |           |       |                |     |
|-----------|-------|----------------|-----|
| 66-15013+ | 66-67 | .....\$ 189.00 | ea. |
|-----------|-------|----------------|-----|



- |           |       |            |                |     |
|-----------|-------|------------|----------------|-----|
| 68-15013+ | 68-74 | 6-cylinder | .....\$ 179.00 | ea. |
|-----------|-------|------------|----------------|-----|



- |           |       |    |                |     |
|-----------|-------|----|----------------|-----|
| 68-15014+ | 68-74 | SB | .....\$ 159.00 | ea. |
| 68-15015+ | 68-72 | BB | .....\$ 169.00 | ea. |

## RADIATOR SUPPORT FRAME RAIL BRACES



- |          |       |                |     |
|----------|-------|----------------|-----|
| 66-15035 | 66-67 | .....\$ 130.00 | pr. |
|----------|-------|----------------|-----|

## RADIATOR TO SUPPORT FILLER SEAL



- |           |       |    |              |     |
|-----------|-------|----|--------------|-----|
| 68-150171 | 69-72 | BB | .....\$ 9.00 | ea. |
|-----------|-------|----|--------------|-----|

## UPPER RADIATOR HOSE



Upper, features correct GM markings

- |          |       |                                      |               |     |
|----------|-------|--------------------------------------|---------------|-----|
| 64-15101 | 64-65 | 283, 327, without AC<br>GM# 3790407  | .....\$ 20.00 | ea. |
| 64-11112 | 64-65 | 283, 327, with AC<br>GM# 3850687     | .....\$ 20.00 | ea. |
| 66-11116 | 66-67 | 283, 327, without AC<br>GM# 3886073  | .....\$ 20.00 | ea. |
| 66-11117 | 66-67 | 283, 327, with AC<br>GM# 3882883     | .....\$ 20.00 | ea. |
| 66-15102 | 66-67 | 327, L-79, without AC<br>GM# 3892682 | .....\$ 20.00 | ea. |
| 66-15103 | 66-67 | 327, L-79, with AC<br>GM# 3882885    | .....\$ 20.00 | ea. |
| 68-15102 | 68    | 327, 350<br>GM# 3923229              | .....\$ 20.00 | ea. |
| 69-15104 | 69-74 | 307, 327, 350<br>GM# 3956662         | .....\$ 20.00 | ea. |
| 67-15106 | 68-70 | 396, 427<br>GM# 3909866              | .....\$ 20.00 | ea. |

## LOWER RADIATOR HOSE



Lower, features correct GM markings.  
For cars with 2-inch radiator spacer.

- |          |       |                                     |               |     |
|----------|-------|-------------------------------------|---------------|-----|
| 64-15108 | 64-67 | 283, 327, without AC<br>GM# 3790408 | .....\$ 20.00 | ea. |
| 64-15109 | 64-67 | 283, 327, with AC<br>GM# 3870316    | .....\$ 20.00 | ea. |
| 66-15110 | 66-67 | 327, L-79, all<br>GM# 3881856       | .....\$ 20.00 | ea. |
| 68-15111 | 68    | 327, 350<br>GM# 3923231             | .....\$ 20.00 | ea. |
| 69-15112 | 69-74 | 307, 327, 350<br>GM# 3959490        | .....\$ 20.00 | ea. |
| 69-15113 | 69-70 | 396, 427<br>GM# 3947809             | .....\$ 20.00 | ea. |

+ The following items require additional shipping and handling.

# CHEVROLET NOVA PARTS



Car Shop Inc. 739 North Batavia Orange, California 92868

## FAN SHROUDS



### Small Block

"Show Quality" reproduction. Will fit 1962-67 V8 conversions.  
 66-15115+ 66-67 V8 .....\$ 120.00 ea.



### Small Block

"Show Quality" reproduction.  
 69-15117+ 69-72 V8 .....\$ 74.00 ea.

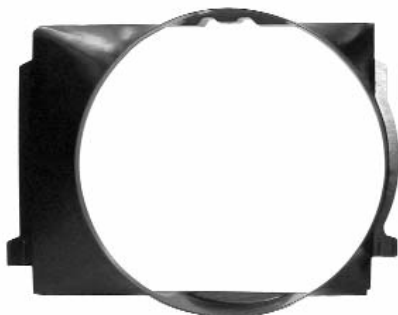

### Big Block

"Show Quality" reproduction.  
 67-15119+ 68 .....\$ 75.00 ea.

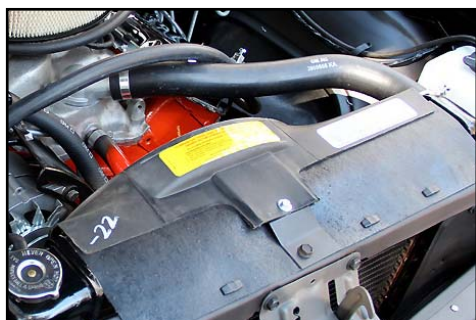

### Big Block

"Show Quality" reproduction.  
 69-151222+ 69-72 Show quality .....\$ 99.00 ea.

Driver quality reproduction.

69-151221+ 69-72 Driver quality .....\$ 77.00 ea.

## FAN SHROUD MOUNTING BRACKETS



68-15127 68-72 B/B .....\$ 11.00 ea.

## FAN SHROUD MOUNTING CLIPS



Lower clip, 2 required.

67-15129 68-74 1/2 inch tall .....\$ 1.00 ea.

67-151291 68-72 1 inch tall .....\$ 3.00 pr.



67-15130 68-70 RH lower clip, fits original 3-core radiators .....\$ 21.00 ea.

## FAN BLADE

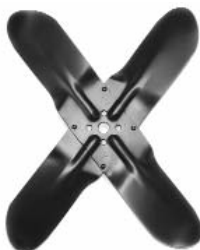

Non-clutch type

67-15204 62-67 4-blade, all, black .....\$ 40.00 ea.



Clutch type, Fits 3" diameter fan clutch bolt pattern.

67-152041 65-68 5-blade, all, black .....\$ 129.00 ea.



Clutch type, with round tips, fits 3 1/4" diameter fan clutch bolt pattern.

Replaces GM #3947772.

69-15204 69-70 7-blade, all, black .....\$ 119.00 ea.

## FAN BLADE



Clutch type, with square tips, fits 3 1/4" diameter fan clutch bolt pattern.

67-15205 66-70 7-blade, 18", black .....\$ 75.00 ea.



Clutch type, Fits 3 1/4" diameter fan clutch bolt pattern.

71-15206 71-74 7-blade, 18", black .....\$ 95.00 ea.

Clutch type, Fits 3" or 3 1/4" diameter fan clutch bolt pattern.

67-152062 universal, 6-blade, 18", black .....\$ 49.00 ea.



Non-clutch type, (replacement)

67-15207 62-74 6-blade, 17", black .....\$ 48.00 ea.

67-15208 62-74 6-blade, 18", black .....\$ 52.00 ea.



Stainless steel blades with black center.

67-152081 62-74 6-blade, 17" .....\$ 32.00 ea.

67-152082 62-74 6-blade, 18" .....\$ 32.00 ea.

+ The following items require additional shipping and handling.

Fax Order 1-714-771-0407 • Toll Free 1-800-235-2470 • [www.TruckandCarShop.com](http://www.TruckandCarShop.com) • 2014 Catalog



# CHEVROLET NOVA PARTS

Car Shop Inc. 739 North Batavia Orange, California 92868

## FAN BLADE SPACER AND BOLT KIT



|          |       |          |         |       |     |
|----------|-------|----------|---------|-------|-----|
| 67-15201 | 62-74 | 1/2 inch | .....\$ | 20.00 | ea. |
| 67-15202 | 62-74 | 1 inch   | .....\$ | 20.00 | ea. |
| 67-15203 | 62-74 | 2 inch   | .....\$ | 24.00 | ea. |

## FAN CLUTCH



Fits 3 1/4" diameter fan clutch bolt pattern.

|          |       |            |         |       |     |
|----------|-------|------------|---------|-------|-----|
| 67-15211 | 65-76 | Standard   | .....\$ | 44.00 | ea. |
| 67-15212 | 65-76 | Heavy duty | .....\$ | 65.00 | ea. |

Fits 3" diameter fan clutch bolt pattern.

|           |       |            |         |       |     |
|-----------|-------|------------|---------|-------|-----|
| 67-152121 | 65-76 | Standard   | .....\$ | 39.00 | ea. |
| 67-152122 | 65-76 | Heavy duty | .....\$ | 49.00 | ea. |

## FAN BLADE BOLTS



Original style, (4) 5/16-24 x 3/4" bolts & 4 lock washers.  
67-15209 62-70 "WB" headmark .....\$ 7.00 set



Original style, (4) 5/16-24 x 3/4" bolts & 4 lock washers.  
67-15210 63-76 "TR" headmark .....\$ 7.00 set

## PINCH CLAMPS



|          |       |                        |         |      |     |
|----------|-------|------------------------|---------|------|-----|
| 67-15220 | 3/8"  | Black, PCV hose        | .....\$ | 1.00 | ea. |
| 67-15221 | 1/4"  | Red, fuel hose         | .....\$ | 1.00 | ea. |
| 67-15222 | 3/8"  | Olive green, fuel hose | ..\$    | 1.00 | ea. |
| 67-15223 | 5/16" | Yellow, fuel hose      | .....\$ | 1.00 | ea. |

## HOSE CLAMPS



|          |       |                |         |      |     |
|----------|-------|----------------|---------|------|-----|
| 67-15218 | 62-68 | 5/8" wire ring | .....\$ | 1.50 | ea. |
| 67-15219 | 62-68 | 3/4" wire ring | .....\$ | 1.50 | ea. |

## HOSE CLAMPS



|             |      |                   |         |          |
|-------------|------|-------------------|---------|----------|
| Tower Style |      |                   |         |          |
| 67-15213    | 5/8" | Heater/smog tubes | .....\$ | 3.00 ea. |
| 67-15214    | 3/4" | Heater            | .....\$ | 3.00 ea. |



|           |         |                 |         |          |
|-----------|---------|-----------------|---------|----------|
| 67-15215  | 2-1/16" | Radiator, upper | .....\$ | 3.00 ea. |
| 67-152161 | 2-3/16" | Radiator, lower | .....\$ | 3.00 ea. |
| 67-15216  | 2-5/16" | Radiator, lower | .....\$ | 3.00 ea. |



|          |      |                            |         |          |
|----------|------|----------------------------|---------|----------|
| 67-15217 | 3/4" | Side screw<br>by-pass hose | .....\$ | 3.50 ea. |
|----------|------|----------------------------|---------|----------|

## RADIATOR AND HEATER HOSE CLAMP KIT



New improved tooling, "WITTEK MFG CO / CHICAGO USA".  
67-15301 62-68 Hose clamp kit .....\$ 18.00 kit



New improved tooling, "WITTEK MFG CO / CHICAGO USA".  
69-15302 69-72 Hose clamp kit  
Tower style .....\$ 22.00 kit

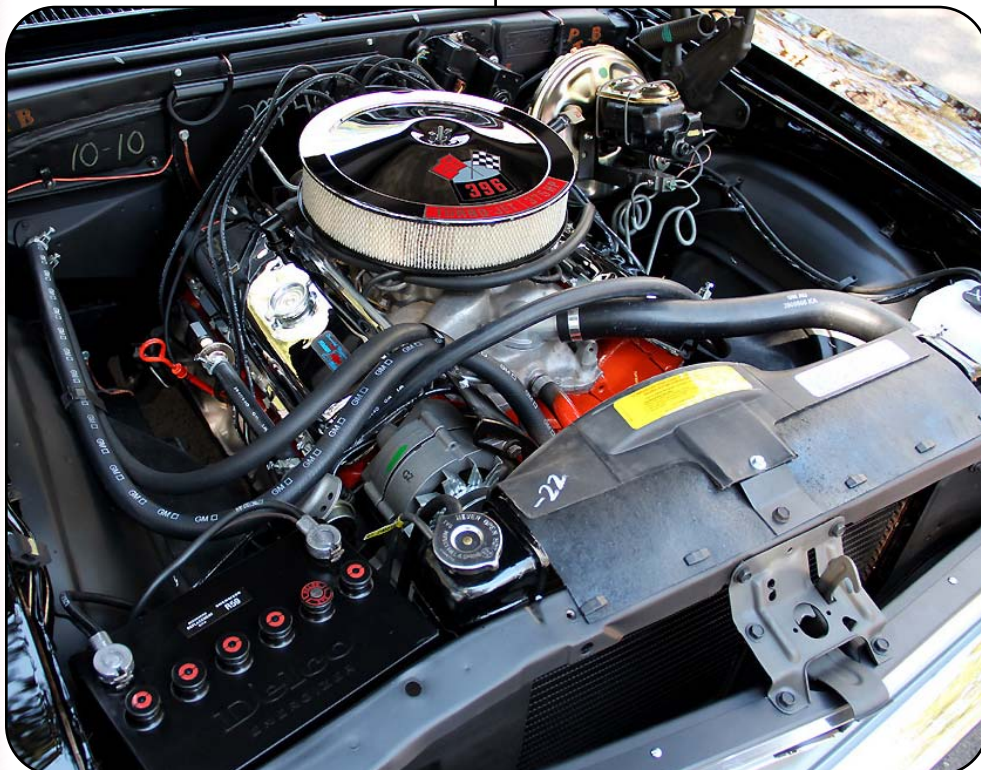

**Showroom hours:**  
**TUESDAY - FRIDAY: 8:30AM to 4:30PM**  
**SATURDAY: 8:30AM to 3:30PM**  
*(Showroom closed Sunday & Monday)*

**Phone order desk hours:**  
**MONDAY - FRIDAY: 8:30AM to 4:30PM**  
**ORDER TOLL FREE: 1-800-235-2470**  
**24 HOUR FAX: 714-771-0407**

# CHEVROLET NOVA PARTS



Car Shop Inc. 739 North Batavia Orange, California 92868

## FENDER SKIRT HEATER HOSE BRACKET



67-15303 62-74 .....\$ 5.00 ea.

This is the metal bracket that attaches to the upper alternator mounting bracket and retains the heater hoses.

69-15304 69-72 Heater hose clamp ...\$ 6.00 ea.

## HEATER HOSE KITS



67-15224 62-74 Smooth with GM logo ..\$ 24.00 pr.

67-15225 69-74 Original ribbed design ..\$ 29.00 pr.

## STARTER REBUILD KIT



67-153041 62-74 .....\$ 48.00 kit

## STARTER BRUSH SET



67-15403 63-74 4-piece .....\$ 5.00 set

## STARTERS



67-15305 63-72 6-cylinder  
63-69 283, 327 & 307  
aluminum nose .....\$ 85.00 ea.



67-15306 67-72 6-cylinder  
66-67 283  
68-69 327  
69-70 350 .....\$ 87.00 ea.  
cast iron nose piece

67-15307 70-74 350, with M.T.  
65-69 396, 427 with M.T.  
70-72 396, 402, 454, with M.T. \$ 152.00 ea.  
cast iron nose piece

70-15308 70-74 350, with A.T.  
70-74 400, 402 & 454, with A.T. \$ 121.00 ea.  
aluminum nose piece

## CHROME MINI-STARTER



Chrome mini starter, All V8's with staggered bolt pattern.

67-153091 64-74 All V8's .....\$ 145.00 ea.



67-15309 64-74 All V8's .....\$ 179.00 ea.

## STARTER BOLT KIT

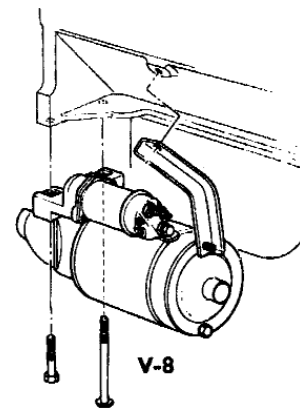

67-15310 63-74 S/B .....\$ 8.00 pr.

67-15311 68-72 B/B .....\$ 8.00 pr.

## STARTER BRACE



67-15312 63-74 S/B .....\$ 10.00 ea.

67-15313 68-72 B/B .....\$ 9.00 ea.

## STARTER SOLENOID



67-15401 62-74 standard .....\$ 18.00 ea.

67-154011 62-74 AC Delco .....\$ 59.00 ea.

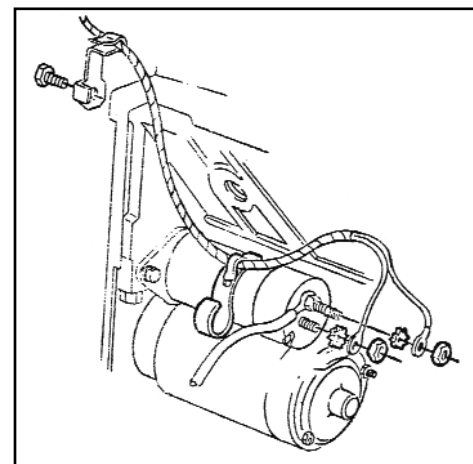

+ The following items require additional shipping and handling.

Fax Order 1-714-771-0407 • Toll Free 1-800-235-2470 • [www.TruckandCarShop.com](http://www.TruckandCarShop.com) • 2014 Catalog



# CHEVROLET NOVA PARTS

Car Shop Inc. 739 North Batavia Orange, California 92868

## STARTER MOTOR / SOLENOID HEAT SHIELD



This heat shield mounts to the solenoid, stainless steel.  
**67-15314** 63-74 solenoid heat shield . . . \$ 15.00 ea.



Reproduction of the original big block starter heat shield, stainless steel.  
**67-153141** 68-72 B/B . . . . . \$ 18.00 ea.



**67-15315** 63-74 Solenoid heat shield insulated . . . . . \$ 20.00 ea.



**67-15316** 63-74 Starter heat shield insulated . . . . . \$ 24.00 ea.



B/B heat shield retainer nut fits original shield.  
**67-15317** 68-72 . . . . . \$ 6.00 ea.

## ALTERNATOR CONVERSION KIT



Converts your existing harness to use an internally regulated alternator.  
**67-15404** 63-72 External to internal regulator harness . . . . . \$ 18.00 kit

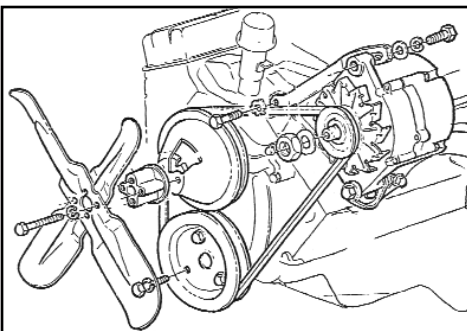

## ALTERNATOR



External type connector

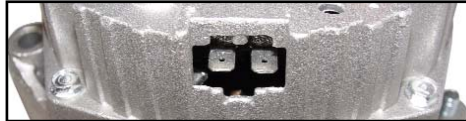

Internal type connector



**67-15406** 63-72 External regulated, 61 Amp . . . . . \$ 74.00 ea.  
**67-15407** Internal regulated, 63 Amp . . . . . \$ 115.00 ea.

## CHROME ALTERNATOR



**67-15408** 63-72 External regulator . . . . \$ 176.00 ea.  
**67-15409** Internal regulator, 1 wire 65 amp . . . . \$ 119.00 ea.  
**67-15410** Internal regulator, 1 wire 100 amp . . . . \$ 129.00 ea.

## CHROME ALTERNATOR FAN, PULLEY AND NUT



**67-15411** 63-74 Single groove . . . . . \$ 17.00 ea.

## DEEP GROOVE ALTERNATOR PULLEY

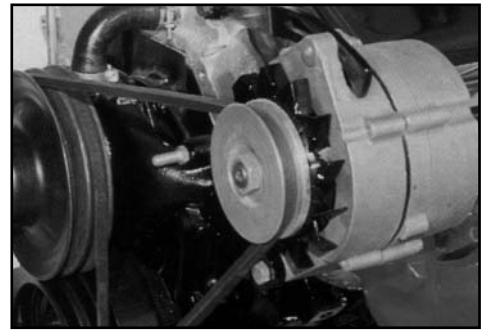

**67-15412** 66-67 . . . . . \$ 40.00 ea.



**68-15413** 68-72 . . . . . \$ 35.00 ea.

## LOWER ALTERNATOR BRACKETS



Lower alternator bracket for cars with short waterpump & headers. Mounts to header with front header bolts, use with #67-15415.  
**67-15414** . . . . . \$ 9.00 ea.



Mounts alternator to #67-15414 header style lower bracket.  
**67-15415** . . . . . \$ 9.00 ea.

## ALTERNATOR ADJUSTER BRACKETS



Upper adjusting bracket, small block, black.  
**64-11412** 62-67 upper . . . . . \$ 24.00 ea.



Upper adjusting brackets, L-79 small block, 2-piece.  
**67-15420** 67-68 upper set . . . . . \$ 68.00 pr.



# CHEVROLET NOVA PARTS



Car Shop Inc. 739 North Batavia Orange, California 92868

## ALTERNATOR ADJUSTER BRACKETS



Universal upper adjusting bracket, straight arm, chrome.  
67-15416 S/B .....\$ 12.00 ea.



Universal upper adjusting bracket, custom straight arm, chrome.  
67-15417 S/B .....\$ 17.00 ea.



Universal upper adjusting bracket, original style, chrome.  
67-15501 68 S/B .....\$ 18.00 ea.

## LOWER ALTERNATOR MOUNTING BRACKET



64-11413 62-67 S/B, black .....\$ 35.00 ea.



67-15502 68 S/B, black .....\$ 28.00 ea.

## ALTERNATOR ADJUSTER BRACKET



Upper adjusting bracket, big block, black.  
67-15503 68 B/B .....\$ 24.00 ea.

Upper adjusting bracket, original style, chrome.  
67-15504 68 B/B .....\$ 20.00 ea.

## ALTERNATOR MOUNTING BRACKET



Lower adjusting bracket, original style, black.  
67-15505 68 B/B .....\$ 38.00 ea.



Lower adjusting bracket, original style, chrome.  
67-15506 68 B/B .....\$ 30.00 ea.

## ALTERNATOR BRACKET SPACER SLEEVE



67-15608 63-68 S/B, .52 O.D. x 1" .....\$ 4.00 ea.  
68-15608 68 B/B, .52 O.D. x .75" .....\$ 4.00 ea.

## ALTERNATOR ADJUSTER BRACKET



69-15507 69-72 S/B, upper .....\$ 37.00 ea.



69-15508 69-72 B/B, upper .....\$ 29.00 ea.

## ALTERNATOR BRACKETS



Small Block V8, rear of upper bracket mounts to water neck, chrome.  
69-15509 69-79 S/B, 2-pc. kit .....\$ 18.00 pr.

Small Block V8, rear of upper bracket mounts to intake, chrome.  
69-15510 69-79 S/B, 2-pc. kit .....\$ 17.00 pr.



Big Block V8, upper adjusting bracket, original style, chrome.  
69-15511 69-72 B/B, chrome .....\$ 17.00 ea.



69-15512 69-72 B/B, lower, chrome .....\$ 7.00 ea.  
69-15513 69-72 B/B, lower .....\$ 14.00 ea.

## SMALL BLOCK ALTERNATOR MOUNTING KIT



69-15514 69-72 S/B, 5-pc. ....\$ 59.00 kit

## BIG BLOCK ALTERNATOR MOUNTING KIT



69-15515 69-72 B/B, 3-pc. ....\$ 54.00 kit

**Showroom hours:**  
**TUESDAY - FRIDAY: 8:30AM to 4:30PM**  
**SATURDAY: 8:30AM to 3:30PM**  
**Phone order desk hours:**  
**MONDAY - FRIDAY: 8:30AM to 4:30PM**

† The following items require additional shipping and handling.

Fax Order 1-714-771-0407 • Toll Free 1-800-235-2470 • [www.TruckandCarShop.com](http://www.TruckandCarShop.com) • 2014 Catalog



# CHEVROLET NOVA PARTS

Car Shop Inc. 739 North Batavia Orange, California 92868

## ALTERNATOR MOUNTING BOLTS



Original "WB" headmark, (1) 5/16-18 x 1" upper adjuster bolt, lock washer and flat washer.  
**67-15601** 63-74 All, adjuster bolt . . . . \$ 2.00 ea.



Original "TR" headmark, (1) 3/8-16 x 4" pivot bolt, lock nut and washer.  
**67-15602** 68 S/B . . . . . \$ 3.50 ea.



Includes the correct upper and lower bolts with special thick washers.  
**69-15603** 69-79 S/B . . . . . \$ 7.00 kit



**69-15604** 69-72 B/B, includes stud . . . . \$ 8.00 kit

## ALTERNATOR SPACER AND BRACE



**69-15605** 69-72 S/B . . . . . \$ 14.00 ea.



Mounts to rear of alternator.  
**69-15607** 69-72 B/B . . . . . \$ 11.00 ea.

## ALTERNATOR / GENERATOR WIRE BOOT



**58-10923** 62 rear rubber boot . . . . \$ 16.00 ea.



**67-15609** 63-79 rear rubber boot . . . . \$ 4.00 ea.

## ALTERNATOR PIGTAIL CONNECTOR



**67-15610** 63-72 wire connector . . . . \$ 4.00 ea.

## SMOG PUMP FAN



This fan is used on all GM models where high performance smog systems were used. Correct opaque/white color  
**68-15544** 68-74 white . . . . . \$ 83.00 ea.

## SMOG PUMP DIVERTER ELBOW



This is the OEM aluminum elbow that bolts to the smog pump, and the diverter valve mounts on the opposite side. GM# 3942533.  
**69-15548** 69-74 S/B . . . . . \$ 42.00 ea.

## SMOG PUMP BRACKET



**67-15530** 68 S/B . . . . . \$ 73.00 ea.



**69-15530** 69-74 S/B . . . . . \$ 42.00 ea.



**69-15532** 69-72 BB . . . . . \$ 42.00 ea.

## SMOG PUMP PULLEY



Deep 1 groove pulley. Number stamped on pulley is 3932458DA.  
**69-15540** 69-72 black . . . . . \$ 83.00 ea.

Deep 1 groove pulley in gray phosphate. 1968-71 396/375 hp. 5 5/8". Number stamped on pulley is 3925522.

**68-15541** 68-71 gray phosphate . . . . \$ 83.00 ea.

## HEADER GASKET SETS

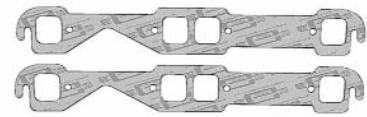

**67-15625** S/B . . . . . \$ 16.00 set

**67-15626** B/B . . . . . \$ 19.00 set

## HEADMAN HEADERS

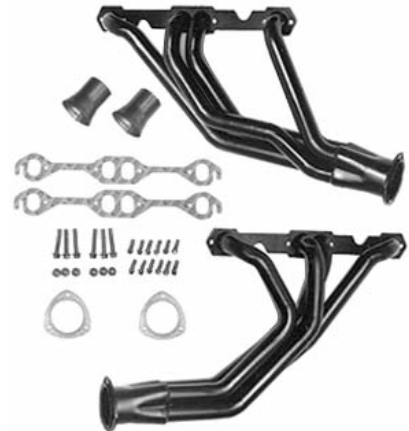

All headers include gaskets and bolts. Made in U.S.A.  
**64-15619+** 64-67 S/B Black finish 1 1/2" . . \$ 269.00 pr.

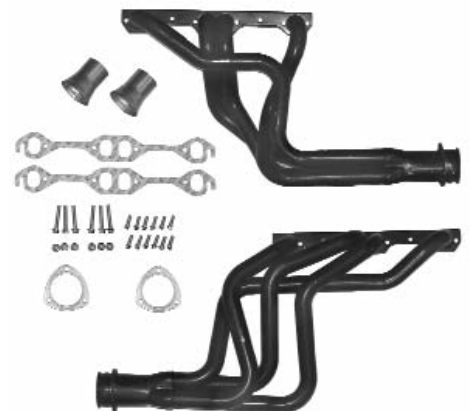

**67-15619+** 68-74 S/B Black finish 1 5/8" . . \$ 249.00 pr.

**67-15621+** 68-72 B/B Black finish 1 3/4" . . \$ 269.00 pr.

# CHEVROLET NOVA PARTS



Car Shop Inc. 739 North Batavia Orange, California 92868

## HEADMAN ELITE HEADERS

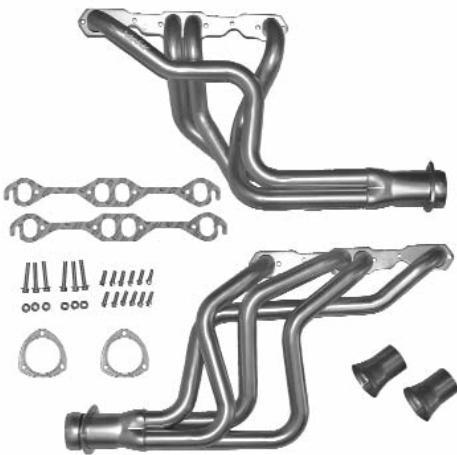

All Elite headers are made from ultra heavy 14 gauge aluminized tubing and 3/8 inch flanges, then a thermal coating is added to resist intense heat and the adverse elements.

Includes gaskets and bolts. **Made in U.S.A.**

64-15622+ 64-67 S/B Silver coated  
1 1/2" .....\$ 499.00 pr.

67-15622+ 68-74 S/B Silver coated  
1 5/8" .....\$ 499.00 pr.

67-15624+ 68-72 B/B Silver coated  
1 3/4" .....\$ 559.00 pr.



69-15620 68-74 S/B A/C adapter bracket  
A/C cars only .....\$ 20.00 ea.

## EXHAUST MANIFOLD BOLTS



Fits Ram-Horn style exhaust manifolds.

58-10334 64-67 S/B .....\$ 20.00 set

Fits rear dump style exhaust manifolds.

67-15701 68-74 S/B 12 pc. 2-1/4"  
with thick washers ....\$ 20.00 set



68-15703 68-72 B/B 16 pc.  
with flange style bolts ..\$ 24.00 set

## SMALL BLOCK EXHAUST MANIFOLDS



67-15706 68 S/B  
without smog holes ...\$ 329.00 pr.



69-15707 69-74 S/B  
without smog holes ...\$ 329.00 pr.



69-15708 69-74 S/B  
with smog holes .....\$ 359.00 pr.

## BIG BLOCK EXHAUST MANIFOLDS



67-15709 68-72 B/B  
with smog holes .....\$ 349.00 pr.

67-15710 68-72 B/B  
without smog holes ...\$ 349.00 pr.

## EXHAUST MANIFOLD STUDS



67-15704 64-74 Stainless steel .....\$ 21.00 set

## EXHAUST MANIFOLD BOLT FRENCH LOCKS

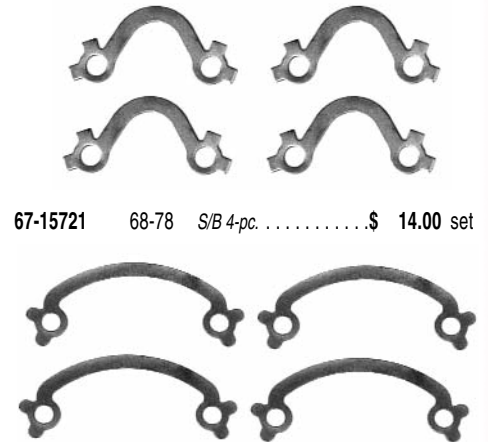

67-15721 68-78 S/B 4-pc. ....\$ 14.00 set

67-15722 68-72 B/B 4-pc. ....\$ 10.00 set

## EXHAUST MANIFOLD HEAT STOVE



69-15760 69-74 upper .....\$ 10.00 ea.



69-15761 69-74 lower .....\$ 32.00 ea.

## EXHAUST MANIFOLD HEAT STOVE RIVETS



69-15765 69-74 5/32 x 3/8 .....\$ 4.00 set

## EXHAUST MANIFOLD SMOG HOLE PLUGS



67-15705 67-74 .....\$ 1.00 ea.

## EXHAUST MANIFOLD GASKETS



67-15711 64-74 S/B .....\$ 9.00 set

67-15712 68-72 B/B .....\$ 13.00 set

+ The following items require additional shipping and handling.

Fax Order 1-714-771-0407 • Toll Free 1-800-235-2470 • [www.TruckandCarShop.com](http://www.TruckandCarShop.com) • 2014 Catalog



# CHEVROLET NOVA PARTS

Car Shop Inc. 739 North Batavia Orange, California 92868

## EXHAUST HEAT RISER VALVE



67-15713 64-74 S/B, 2" ..... \$ 59.00 ea.



67-15714 68-72 B/B, 2 1/2" ..... \$ 68.00 ea.



67-15715 64-74 S/B flow through type,  
2" no flap ..... \$ 36.00 ea.



67-15716 68-72 B/B flow through type,  
2 1/2" no flap ..... \$ 31.00 ea.

## HEAT RISER GASKET



67-15717 64-74 S/B, 2" Donut ..... \$ 4.00 ea.



67-15719 68-72 B/B, 2 1/2" Donut ..... \$ 4.00 ea.

67-15718 64-74 S/B, 2" Flat ..... \$ 3.00 ea.

67-15720 68-72 B/B, 2 1/2" Flat ..... \$ 3.00 ea.

## EXHAUST MANIFOLD HEADPIPE EXTENSION

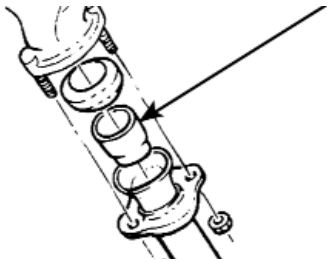

Fits between the exhaust manifold and the headpipe, supports the main headpipe donut gasket.

67-15730 64-74 2" OD ..... \$ 13.00 ea.

67-15731 68-72 2 1/2" OD ..... \$ 13.00 ea.

## FLOWMASTER MUFFLERS



**FLOWMASTER - 40 Series - Original Flowmaster Tone.** Made of aluminized steel for street or race applications and is the most aggressive-sounding street and strip muffler in Flowmaster's line. Also great for dual exhaust systems.

4" x 9.75" x 13" - 19" Overall Length.

67-157311 2 1/4" offset inlet / center outlet . . . \$ 105.00 ea.

67-157312 2 1/2" offset inlet / center outlet . . . \$ 105.00 ea.

67-157313 2 1/4" offset inlet / offset outlet . . . \$ 105.00 ea.

67-157314 2 1/2" offset inlet / offset outlet . . . \$ 105.00 ea.

**FLOWMASTER - 50 Series -**

4" x 9.75" x 17" - 23" Overall Length.

67-157315 3" offset inlet / offset outlet . . . . . \$ 119.00 ea.

## EXHAUST HANGER KITS



Standard dual exhaust hanger & clamp kit, includes front and rear hangers and clamps.

67-15751 68-72 zinc plated ..... \$ 74.00 kit



Chambered dual exhaust hanger & clamp kit, includes front and rear hangers, reinforcement tabs for front hangers and clamps, non-plated. All hangers are correct.

67-15755 68-71 ..... \$ 119.00 kit

## EXHAUST CLAMPS



zinc plated

67-15740 62-74 2" ..... \$ 4.50 ea.

67-15741 62-74 2 1/4" ..... \$ 4.50 ea.

67-15742 62-74 2 1/2" ..... \$ 4.50 ea.

stainless steel

67-15743 62-74 2" ..... \$ 8.00 ea.

67-15744 62-74 2 1/4" ..... \$ 8.00 ea.

67-15745 62-74 2 1/2" ..... \$ 13.00 ea.

## ORIGINAL STYLE AIR CLEANER



1959-65 S/B style, 4 3/8" neck.

59-077242 64-65 black, oval opening . . . \$ 144.00 ea.



1959-65 S/B style, 4 3/8" neck.

59-077241 64-65 black, round opening . . . \$ 144.00 ea.



Carb throat size - 5 1/8", with black lid.

67-15803 66-67 S/B, 4BBL, black lid . . . \$ 144.00 ea.



+ The following items require additional shipping and handling.

# CHEVROLET NOVA PARTS



Car Shop Inc. 739 North Batavia Orange, California 92868

## 14" AIR CLEANERS



Replacement air cleaner with 3 inch paper filter.  
**67-15801** 4 BBL, recessed base, chrome . . . \$ 24.00 ea.



Replacement air cleaner with 3 inch washable filter.  
**67-158012** 4 BBL, recessed base, chrome . . . \$ 36.00 ea.



Replacement air cleaner with 3 inch paper filter. 14" dia.  
**67-158013** 4 BBL, recessed base, black . . . \$ 20.00 ea.

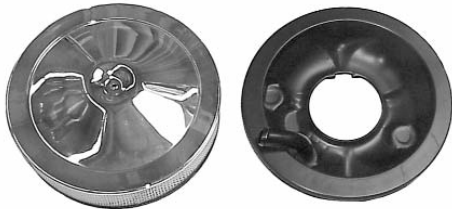

Original GM style reproduction with correct top and deep recessed base, includes 3 inch paper filter. 5 1/8" neck.  
**67-15802** 66-69 4BBL . . . \$ 89.00 ea.



Correct deep recessed base. 5 1/8" neck.  
**67-158021** 66-69 4BBL . . . \$ 59.00 ea.



## DUAL SNORKEL AIR CLEANER



4BBL, L-79 Nova style, carb throat size - 5 1/8".  
**64-15804** with chrome lid . . . \$ 349.00 ea.



4BBL, L-79 Chevelle style, carb throat size - 5 1/8".  
**64-11916** with chrome lid . . . \$ 335.00 ea.



4BBL, L-79 Nova style, carb throat size - 5 1/8".  
**64-15805** base only . . . \$ 199.00 ea.



With short oval inlet snorkels, carb throat size - 5 1/8".  
 Used on 1970-1972 Z/28 & Chevelle SS.  
**70-15805** 70-72 with chrome lid . . . \$ 199.00 ea.  
**70-15806** 70-72 with black lid . . . \$ 180.00 ea.



With long round inlet snorkels, features correct snout with notch & pcv dimple on the outside. Used on L78 & L89.  
**70-158062** 70-72 . . . \$ 395.00 ea.

## POLISHED ALUMINUM AIR CLEANERS

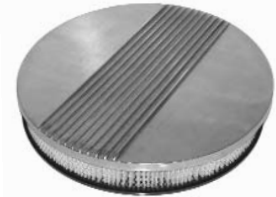

Cal Custom finned aluminum air cleaner, 5 1/8" neck.  
**67-158065** 14" with fins . . . \$ 75.00 ea.



Polished aluminum, round, with recessed base, 5 1/8" neck.  
**67-15807** 14" Ball milled . . . \$ 49.00 ea.



Polished aluminum, round, with recessed base, 5 1/8" neck.  
**67-15808** 14" With flames . . . \$ 54.00 ea.



Polished aluminum, oval, with washable filter, 5 1/8" neck.  
**67-15809** 15" Ball milled, oval . . . \$ 75.00 ea.



Polished aluminum, oval, with washable filter, 5 1/8" neck.  
**67-15810** 15" With flames, oval . . . \$ 79.00 ea.



† The following items require additional shipping and handling.

Fax Order 1-714-771-0407 • Toll Free 1-800-235-2470 • [www.TruckandCarShop.com](http://www.TruckandCarShop.com) • 2014 Catalog



# CHEVROLET NOVA PARTS

Car Shop Inc. 739 North Batavia Orange, California 92868

## AIR CLEANER ELEMENT



Replacement element, AC# A86CW.

67-158112 62-68 11.5" x 3", paper . . . . \$ 10.00 ea.



Replacement element, AC# A212CW.

67-15811 66-72 14" x 3", paper . . . . \$ 9.00 ea.



67-15812 14" x 5", paper . . . . . \$ 22.00 ea.



67-15901 washable, K&N, 14 x 3" . . . . . \$ 50.00 ea.  
67-159011 washable, import, 14 x 3" . . . . . \$ 20.00 ea.

## AIR CLEANER SPACERS



67-15902 1/2" Tall . . . . . \$ 4.00 ea.  
67-15903 1" Tall . . . . . \$ 4.00 ea.

## AIR CLEANER WING NUT



67-15904 66-72 Chrome . . . . . \$ 3.00 ea.



67-159041 Chrome & black . . . . . \$ 5.00 ea.

## AIR CLEANER BASE FLAME ARRESTOR



67-15905 66-72 . . . . . \$ 8.00 ea.

## AIR CLEANER STUD



Correct air cleaner stud for Small and Big Block cars equipped with Holley carbs, cadmium plated.

Fits GM style deep base open element air cleaner.

67-15906 66-72 . . . . . \$ 8.00 ea.

## AIR CLEANER LID SEAL



67-15907 All Fits closed element air cleaners cut to fit . . . . . \$ 9.00 ea.

## AIR CLEANER TO CARB GASKET



67-15908 66-72 5-1/8" . . . . . \$ 3.00 ea.

## CHROME AIR CLEANER LID



This is the optional chrome lid only. 14"

67-15909 67-69 Open element . . . . . \$ 39.00 ea.



This is the optional chrome lid only. 17"

67-15910 66-67 Closed element & 70-72 Dual snorkel . . . . . \$ 57.00 ea.

## CHOKE TUBE INSULATION



58-08734 64-65 15" long . . . . . \$ 8.00 ea.  
58-08735 64-65 9 3/4" long . . . . . \$ 6.00 ea.

## EXHAUST MANIFOLD CHOKE HEAT TUBE Baffle



58-10345 64-66 283, 327, 4 BBL . . . . . \$ 7.00 ea.

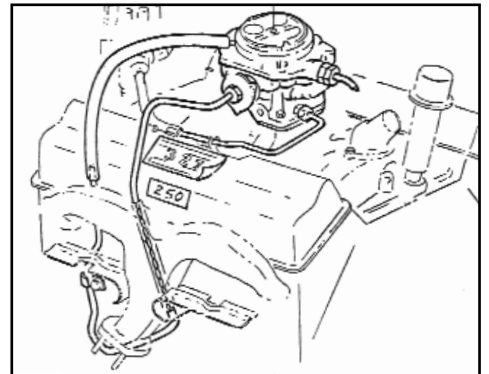

\* The following items require additional shipping and handling.

# CHEVROLET NOVA PARTS



Car Shop Inc. 739 North Batavia Orange, California 92868

## CHOKE KITS



Our reproduction chokes look very similar to the originals. includes the choke spring (thermostat), housing, rod, screw and attaching clip. Available for most Special Hi-Performance applications.

- 67-16101 67-69 S/B with Holley & Z28 or LT-1 intake . . . \$ 29.00 kit
- 67-16102 66-70 S/B with Q-Jet . . . . . \$ 29.00 kit



- 67-16103 68-69 B/B with Holley . . . . . \$ 29.00 kit
- 67-16104 68-69 B/B with Q-Jet . . . . . \$ 29.00 kit



- 70-16105 70-72 B/B with Holley . . . . . \$ 38.00 kit
- 70-16106 70-72 B/B with Q-Jet . . . . . \$ 38.00 kit

## CHOKE COVER



- 67-16107 66-70 . . . . . \$ 5.00 ea.

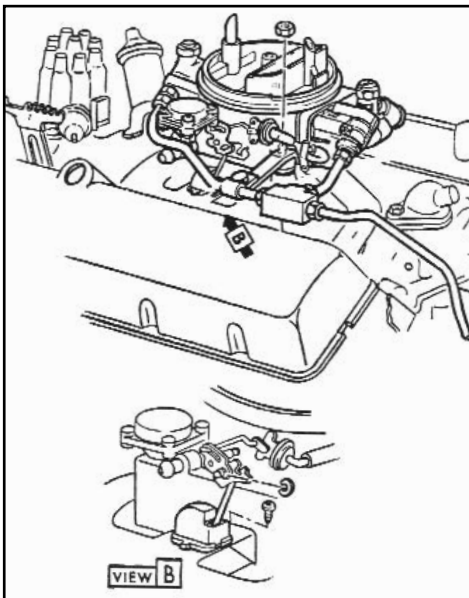

## CARBURETOR MOUNTING KIT



Includes 4 studs, 4 lock washers and nuts.

- 67-16108 64-74 . . . . . \$ 7.00 kit



Includes 2 bolts, 2 studs and 2 nuts.

- 67-161081 65-74 fits quadrajets, 4BBL . . . \$ 8.00 kit

## CARBURETOR ADAPTER KIT



Adapts Edelbrock to Q-Jet.

- 67-161091 . . . . . \$ 30.00 kit



Adapts Holley/AFB to Q-Jet.

- 67-161092 . . . . . \$ 18.00 kit

Quadra-Jet to Holley carburetor adapter plate with hardware.

- 67-16109 . . . . . \$ 28.00 kit



This kit includes: Carb adapter, adapter bolts and gaskets. Adapts Holley 2 BBL to Rochester 2 BBL.

- 67-161093 . . . . . \$ 25.00 kit

## HOLLEY CARBURETORS



### HOLLEY 600 CFM 4-BBL

Single feed, manual choke with vacuum secondaries. Bright silver finish!

- 67-16110 600 CFM . . . . . \$ 316.00 ea.



Single feed, electric choke with vacuum secondaries. Bright silver finish!

- 67-161102 600 CFM . . . . . \$ 337.00 ea.



### HOLLEY 650 & 750 CFM 4-BBL

Model 4150, dual feed, double pump, manual choke with mechanical secondaries. Gold chromate finish!

- 67-16111 650 CFM . . . . . \$ 449.00 ea.
- 67-16112 750 CFM . . . . . \$ 529.00 ea.



### HOLLEY 750 CFM 4-BBL

Model 4160, dual feed, vacuum secondaries with manual choke. Bright silver finish!

- 67-16113 750 CFM . . . . . \$ 359.00 ea.

+ The following items require additional shipping and handling.



# CHEVROLET NOVA PARTS

Car Shop Inc. 739 North Batavia Orange, California 92868

## HOLLEY CARBURETORS



### HOLLEY "STREET AVENGER" 4-BBL

Model 4160, dual feed, vacuum secondaries with electric choke. Bright silver finish!

- |          |         |                     |
|----------|---------|---------------------|
| 67-16114 | 570 CFM | ..... \$ 399.00 ea. |
| 67-16115 | 670 CFM | ..... \$ 419.00 ea. |
| 67-16116 | 770 CFM | ..... \$ 459.00 ea. |

## 1970 HOLLEY CARBURETORS

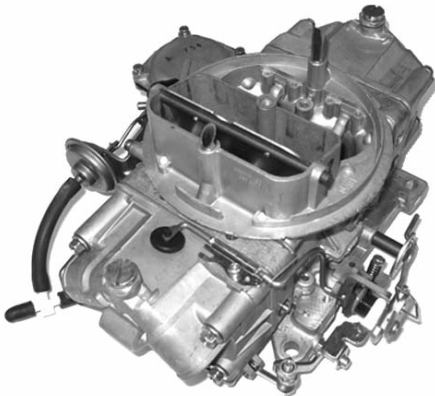

### 1970 HOLLEY CARBURETOR LIST 4557 (GM # 3967477)

This carb was used on 1970 applications like LS6, L78, L89, 396, 454 high performance motors with manual transmission. New.

- |           |    |         |                     |
|-----------|----|---------|---------------------|
| 70-161155 | 70 | with MT | ..... \$ 749.00 ea. |
|-----------|----|---------|---------------------|



### 1970 HOLLEY CARBURETOR LIST 4492 (GM # 3969898)

This carb was used on 1970 applications like LS6, L78, L89, 396, 454 high performance motors with automatic transmission. New.

- |           |    |         |                     |
|-----------|----|---------|---------------------|
| 70-161156 | 70 | with AT | ..... \$ 749.00 ea. |
|-----------|----|---------|---------------------|

## EDELBROCK CARBURETORS



### MANUAL CHOKE

Single feed, manual choke. Bright silver finish!

- |           |                |                     |
|-----------|----------------|---------------------|
| 67-161161 | 600 CFM (1405) | ..... \$ 349.00 ea. |
| 67-161162 | 750 CFM (1406) | ..... \$ 379.00 ea. |



### ELECTRIC CHOKE

Single feed, electric choke. Bright silver finish!

- |           |                |                     |
|-----------|----------------|---------------------|
| 67-161163 | 600 CFM (1407) | ..... \$ 359.00 ea. |
| 67-161164 | 750 CFM (1411) | ..... \$ 399.00 ea. |

## EDELBROCK CARBURETOR CALIBRATION KIT



All calibration kits include an assortment of metering rods and jets, one pair of metering rod retaining springs and a complete assortment of step-up springs.

- |           |                                  |        |           |
|-----------|----------------------------------|--------|-----------|
| 67-161165 | Fits model # 1405                |        |           |
|           | 6 pairs of rods, 5 pairs of jets | ... \$ | 81.00 kit |
| 67-161166 | Fits model # 1406                |        |           |
|           | 3 pairs of rods, 3 pairs of jets | ... \$ | 52.00 kit |
| 67-161167 | Fits model # 1411                |        |           |
|           | 4 pairs of rods, 4 pairs of jets | ... \$ | 63.00 kit |

## FUEL VAPOR CAN BOLT KIT



- |          |       |          |                   |
|----------|-------|----------|-------------------|
| 70-16125 | 70-73 | 4 pieces | ..... \$ 2.50 kit |
|----------|-------|----------|-------------------|

## EDELBROCK FUEL INLET KIT



Fits Edelbrock carburetors.

- |           |        |                    |
|-----------|--------|--------------------|
| 67-161175 | chrome | ..... \$ 25.00 kit |
|-----------|--------|--------------------|



Fits Edelbrock carburetors.

- |           |             |                    |
|-----------|-------------|--------------------|
| 67-161176 | banjo style | ..... \$ 16.00 kit |
|-----------|-------------|--------------------|

## HOLLEY DUAL FEED FUEL INLET KIT



Fits holley models 4150 and 4160. Steel braided line, with anodized fittings.

- |          |                    |
|----------|--------------------|
| 67-16117 | ..... \$ 89.00 kit |
|----------|--------------------|

## HOLLEY DUAL FEED FUEL FITTING



Fitting, Carburetor Inlet, 7/8-20 in. Male to 1/2-20 in. Female Inverted Flare, 5/16 in. Line

- |           |                   |
|-----------|-------------------|
| 67-161172 | ..... \$ 9.00 ea. |
|-----------|-------------------|

## FUEL PUMP TO DUAL FEED INLET, HOSE AND FITTING KIT



Fuel pump to dual feed inlet. Steel braided line, with anodized fittings, 3/8" fittings.

- |           |     |                    |
|-----------|-----|--------------------|
| 67-161181 | S/B | ..... \$ 45.00 ea. |
| 67-161191 | B/B | ..... \$ 60.00 ea. |

## FUEL PRESSURE REGULATOR



4 1/2-9 PSI, 3/8" NPT ports. with mounting bracket and hardware.

- |          |                    |
|----------|--------------------|
| 67-16201 | ..... \$ 38.00 ea. |
|----------|--------------------|

+ The following items require additional shipping and handling.



# CHEVROLET NOVA PARTS



Car Shop Inc. 739 North Batavia Orange, California 92868

## FUEL PRESSURE GAUGE



Holley white face fuel pressure gauge, 0-15 psi.

67-16202 .....\$ 39.00 ea.

## FUEL PRESSURE GAUGE ADAPTER



67-16203 3/8" with clamps. ....\$ 15.00 ea.

## CHROME FUEL PUMP BLOCK OFF PLATES



67-16204 64-79 S/B, Includes gasket ...\$ 5.00 ea.  
 67-16205 64-79 S/B plate gasket .....\$ 2.00 ea.  
 67-16206 68-72 B/B, Includes gasket ...\$ 5.00 ea.  
 67-16207 68-72 B/B plate gasket .....\$ 2.50 ea.

## FUEL PUMPS



Brand new fuel pumps. Includes new mounting gasket.

62-16208 62-66 4 or 6-cylinder .....\$ 49.00 ea.



67-16208 67-74 4 or 6-cylinder .....\$ 29.00 ea.

## FUEL PUMPS



Brand new fuel pumps. Includes new mounting gasket.

64-12219 64-65 283 All .....\$ 29.00 ea.  
 66 283 w/2BBL .....\$ 29.00 ea.

64-12220 64-66 327 .....\$ 62.00 ea.  
 66 283 w/4BBL .....\$ 62.00 ea.



67-16209 67 327 w/5/16" fuel lines ...\$ 25.00 ea.

67-16210 67 327 w/3/8" Fuel lines .....\$ 25.00 ea.  
 67 302 .....\$ 25.00 ea.  
 68 327 & 350 .....\$ 25.00 ea.  
 69-73 307 & 327 .....\$ 25.00 ea.



67-16211 68-72 396 .....\$ 29.00 ea.



69-16212 69 350 .....\$ 25.00 ea.  
 70-79 350 2BBL .....\$ 25.00 ea.



70-16213 70-79 350 4BBL .....\$ 25.00 ea.  
 70-12228 70 396 w/Q-Jet .....\$ 32.00 ea.

## REPRODUCTION AC DELCO FUEL PUMPS



New reproduction AC Delco large logo fuel pump. Delco # 40727.

67-16220 68-72 B/B .....\$ 65.00 ea.



New reproduction AC Delco large logo fuel pump. Delco # 40503.

67-16222 67-68 327 w/5/16" fuel lines ...\$ 65.00 ea.



New reproduction AC Delco large logo fuel pump. Delco # 40963.

This pump has the large reservoir tank with return line.  
 70-16224 70-72 B/B .....\$ 65.00 ea.

## CHROME FUEL PUMPS



RPC Chrome Fuel Pump.  
 67-16214 S/B .....\$ 60.00 ea.



Holley Chrome Fuel Pump, 60 GPH  
 67-16214 S/B .....\$ 94.00 ea.  
 67-16215 B/B .....\$ 96.00 ea.

\* The following items require additional shipping and handling.



# CHEVROLET NOVA PARTS

Car Shop Inc. 739 North Batavia Orange, California 92868

## EDELBRUCK HIGH VOLUME FUEL PUMPS



Edelbrock high volume fuel pumps, chrome, 130 GPH, 3/8" inlet & outlet. Produces 10 PSI. Includes mounting bolts & gasket.

- 67-16216 S/B ..... \$ 149.00 ea.
- 67-16217 B/B ..... \$ 149.00 ea.

## FUEL PUMP GASKET



- 67-16207 All ..... \$ 2.50 ea.

## FUEL PUMP MOUNTING PLATE



- 67-16301 64-79 S/B ..... \$ 9.00 ea.
- 67-16205 64-79 Mounting plate gasket . . \$ 2.00 ea.



Original "L" headmark, 1/4-20 x 1/2" bolt.

- 67-16303 64-79 S/B lower mounting plate bolt ..... \$ 1.50 ea.

## FUEL PUMP ROD



- 67-16304 62-79 All, 1/2" diameter 5-3/4" long ..... \$ 14.00 ea.

## FUEL PUMP MOUNTING BOLTS



Includes 2 bolt and 2 lock washers. Original headmark, 3/8-16 x 1 7/16".

- 67-16306 64-79 S/B ..... \$ 4.00 pr.
- 67-16307 68-72 B/B ..... \$ 4.00 pr.

## FUEL LINE TO FUEL PUMP HOSE

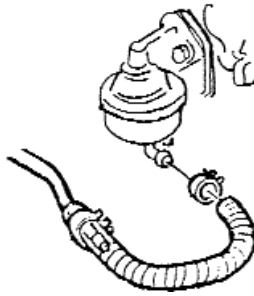

- 67-16308 62-74 3/8" with 2 clamps, 12" . . \$ 5.00 ea.

## FUEL HOSE AND CLAMP KIT



- 67-16309 62-74 5/16" with 8 clamps, 36" . \$ 9.00 kit
- 67-16310 62-74 3/8" with 8 clamps, 36" . . \$ 9.00 kit

## FUEL BLOCKS



- 67-16312 69-70 All Holley models "Yblock" ..... \$ 22.00 ea.
- 70-16313 70 LS6, "Fblock" ..... \$ 22.00 ea.

## GAS HOSE PINCH CLAMP



- Green pinch clamp for use with 3/8" gas lines.
- 67-16314 62-74 3/8" green ..... \$ 1.00 ea.
- Red pinch clamp for use with 1/4" vapor return lines.
- 69-16315 69-72 1/4" red ..... \$ 1.00 ea.

## FUEL BOWL CARBURETOR FITTING



- From filter to carburetor**
- 58-078112 62-65 1/8" x 1/8" ..... \$ 3.50 ea.
  - 58-078113 62-65 1/8" x 5/16" ..... \$ 5.50 ea.
- From fuel line to filter**
- 58-078114 62-65 ..... \$ 4.00 ea.

## FUEL FILTERS



- 58-0781121 62-65 with AC logo ..... \$ 24.00 ea.



- 58-07812 62-65 Element & gasket . . . . \$ 5.00 ea.

## INLINE FUEL FILTER



Keg style fuel filter.

- 67-16316 5/16" Inlet ..... \$ 4.00 ea.
- 67-163162 3/8" Inlet ..... \$ 4.00 ea.

Keg style chrome fuel filter.

- 48-26182 5/16" Inlet ..... \$ 7.00 ea.
- 48-26183 3/8" Inlet ..... \$ 8.00 ea.

## CHROME INLINE FUEL FILTER



- 67-16317 5/16" Inlet ..... \$ 9.00 ea.
- 67-16318 3/8" Inlet ..... \$ 9.00 ea.

## FUEL FILTER & BRACKET

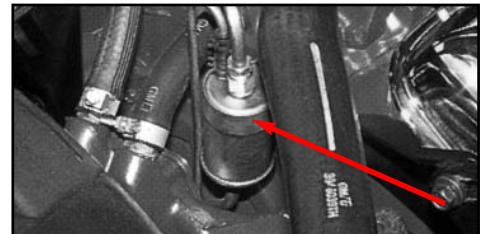

- Fits 1969-70 Big block with Q-jet & 1969-71 small block with Q-jet.
- 69-16319 69-71 filter bracket ..... \$ 14.00 ea.



- Fits 1969-70 Big block with Q-jet & 1969-71 small block with Q-jet.
- 69-16320 69-71 filter ..... \$ 55.00 ea.

# CHEVROLET NOVA PARTS



Car Shop Inc. 739 North Batavia Orange, California 92868

## FUEL PUMP TO CARB LINES (ORIGINAL)



### ORIGINAL MATERIAL

64-11711 62-66 6-cylinder 5/16" . . . . . \$ 20.00 ea.



67-16401 67-69 6-cylinder 5/16" . . . . . \$ 20.00 ea.

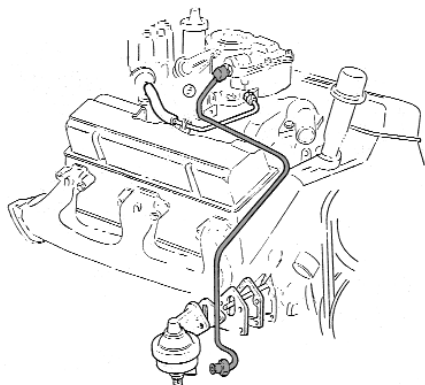

64-11712 64 327/300 HP, 4 bbl. . . . . \$ 20.00 ea.  
 64-11713 64 327/250 HP, 4 bbl. . . . . \$ 20.00 ea.  
 65-11714 65 283, 2 bbl. . . . . \$ 20.00 ea.  
 66-11715 66 283, 2 bbl. . . . . \$ 20.00 ea.  
 66-11716 66 327, 2 bbl. . . . . \$ 20.00 ea.  
 66-16402 66-67 327, L79, Chrome . . . . . \$ 30.00 ea.  
 67-16402 67-68 327, 2BBL, 5/16" . . . . . \$ 20.00 ea.  
 67-16403 67-68 327, 4BBL, 5/16" . . . . . \$ 20.00 ea.  
 67-16404 67-69 350, 4BBL, 3/8" . . . . . \$ 20.00 ea.

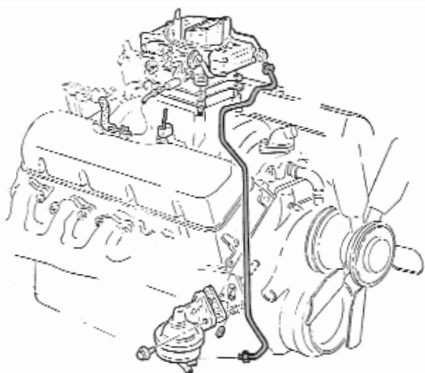

67-16405 68 396/325 HP, Quadra jet, 1 piece line . . . . . \$ 20.00 ea.  
 69-16406 69-70 307, 2BBL . . . . . \$ 20.00 set  
 69-16407 69-70 350/255 HP, 4BBL . . . . . \$ 20.00 ea.

## FUEL PUMP TO CARB LINES (ORIGINAL)



69-16408 69 350/255 & 300 HP, with return, 3 piece set . . . . . \$ 28.00 set



69-16409 69 396/325 HP, with return, 3 piece set . . . . . \$ 28.00 set

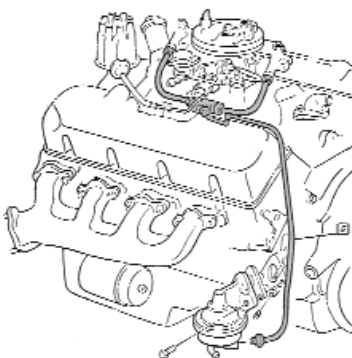

67-16411 68 396/375 HP, includes 3 lines and fuel block . . . . . \$ 46.00 set  
 69-16413 69 396/375 HP, includes 3 lines and fuel block . . . . . \$ 46.00 set



LS6 with short fuel pump, 3 line set, 3-way fitting sold separately.  
 70-11734 70 . . . . . \$ 28.00 set  
 LS6 with long fuel pump, 3 line set, 3-way fitting sold separately.  
 70-11735 70 . . . . . \$ 28.00 set



70-16313 70 LS6 3-way brass fitting . . . . . \$ 22.00 ea.



71-11738 71-72 350/270 HP, 4 BBL . . . . . \$ 20.00 ea.  
 71-11737 71-72 402, 4 BBL . . . . . \$ 18.00 ea.  
 73-16415 73 350, 2BBL . . . . . \$ 20.00 ea.  
 73-16416 73-74 350, 4BBL . . . . . \$ 20.00 ea.

## FUEL TANK TO PUMP FUEL LINES

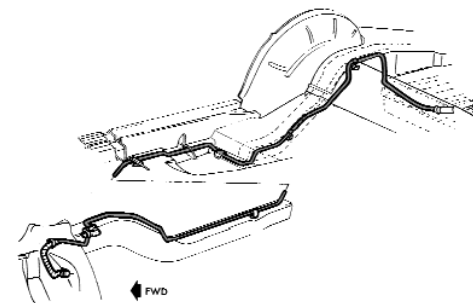

### ORIGINAL MATERIAL

62-16435+ 62-67 6-cylinder 5/16" diameter line . . . . . \$ 67.00 ea.  
 62-16436+ 62-67 8-cylinder, exc L-79 5/16" diameter line . . . . . \$ 67.00 ea.  
 66-16437+ 66-67 8-cylinder, L-79 3/8", 1-piece line . . . . . \$ 67.00 ea.  
 66-16438+ 66-67 8-cylinder, L-79 3/8", 2-piece line . . . . . \$ 67.00 ea.  
 68-16439+ 68 8-cylinder 3/8" diameter line . . . . . \$ 67.00 ea.  
 69-16441+ 69-73 8-cylinder 3/8", 2-piece line . . . . . \$ 67.00 ea.

### STAINLESS STEEL

62-16445+ 62-67 6-cylinder 5/16" diameter line . . . . . \$ 95.00 ea.  
 62-16446+ 62-67 8-cylinder, exc L-79 5/16" diameter line . . . . . \$ 95.00 ea.  
 66-16447+ 66-67 8-cylinder, L-79 3/8", 1-piece line . . . . . \$ 95.00 ea.  
 66-16448+ 66-67 8-cylinder, L-79 3/8", 2-piece line . . . . . \$ 95.00 ea.  
 68-16449+ 68 8-cylinder 3/8" diameter line . . . . . \$ 95.00 ea.  
 69-16451+ 69-73 8-cylinder 3/8", 2-piece line . . . . . \$ 95.00 ea.

## FUEL RETURN LINES



### ORIGINAL MATERIAL

1/4" diameter return line.  
 69-16502+ 69-73 return line . . . . . \$ 67.00 ea.

### STAINLESS STEEL

69-16503+ 69-73 return line . . . . . \$ 95.00 ea.

## FUEL LINE GUIDE BRACKET



69-16519 68-72 A . . . . . \$ 12.00 ea.

+ The following items require additional shipping and handling.

Fax Order 1-714-771-0407 • Toll Free 1-800-235-2470 • www.TruckandCarShop.com • 2014 Catalog



# CHEVROLET NOVA PARTS

Car Shop Inc. 739 North Batavia Orange, California 92868

## INTAKE MANIFOLDS



### ZZ350 Aluminum Intake Manifold—Original GM

This manifold is used on all ZZ series 350 HO engines and also can be used on all small-block Chevrolet's thru 1986. Fits Holley or Quadrajet carb.

67-165201 S/B ..... \$ 295.00 ea.



### Power+Plus Cyclone Intake Manifold

Provides outstanding power from idle to 5500 RPM. Power+Plus Cyclone Manifold is a direct replacement for the stock manifold on 1957-'95 Small Block Chevy non-EGR engines. Includes special adapter bushings to fit '87-'95 engines.

67-16521 S/B, show polished ..... \$ 237.00 ea.

67-16522 S/B, satin ..... \$ 179.00 ea.



### Power+Plus Typhoon Intake Manifold

Provides outstanding power from 1500 to 6500 RPM. Designed to be used with Holley, Carter AFB, or Edelbrock square bore carburetors. This manifold produces power comparable to some single plane manifolds yet retains the throttle response and drive ability typical of a dual plane.

67-16523 S/B, show polished ..... \$ 249.00 ea.

67-16524 S/B, satin ..... \$ 195.00 ea.



### Power+Plus Crosswind intake manifold with air gap

Provides outstanding power from 1500 to 6500 RPM. Designed to be used with Holley, Carter AFB, or Edelbrock square bore carburetors. The air gap separates the runners from the hot engine oil. This results in a cooler air/fuel mixture which creates more power.

67-16525 S/B, show polished ..... \$ 310.00 ea.

67-16526 S/B, satin ..... \$ 235.00 ea.

## INTAKE MANIFOLDS



### High Performance Racing Manifold

Small block single plane 360° design. Provides outstanding power in the mid-to upper RPM ranges. 3,500 RPM to 7800 RPM. Features include nitrous bosses, dual distributor hold downs and 4 corner water ports.

67-16527 S/B, show polished ..... \$ 309.00 ea.

67-16528 S/B, satin ..... \$ 229.00 ea.

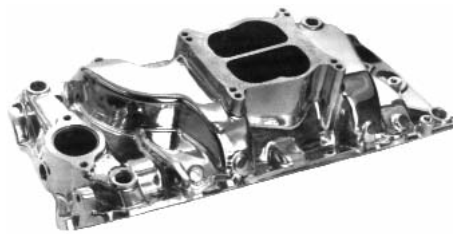

### Power+Plus Cyclone Intake Manifold

Big block dual plane 180° design. Provides outstanding power from idle to 5500 RPM. Replacement for 1965-83 big block non-EGR engines.

67-16529 B/B, show polished ..... \$ 270.00 ea.

67-16530 B/B, satin ..... \$ 219.00 ea.



### Power+Plus Crosswind intake manifold with air gap

Provides outstanding power from 1500 to 6500 RPM. Features oval ports, nitrous bosses, dual distributor holddowns and four corner water ports. This is the ultimate street manifold for 396, 427, 454 or 502 big block engines. It features a raised plenum area that allows air to pass under the plenum, producing a cooler intake charge with a resultant increase in power and torque output.

67-16533 B/B, show polished ..... \$ 399.00 ea.

67-16534 B/B, satin ..... \$ 336.00 ea.



### 396, 427 / 375 HP Intake Manifold

New Big block 1968-69 intake manifold # 3933163. Used on all high performance 396, 427 / 375 HP models. With correct "W" snowflake, Winters castings. Replaces GM # 3933163. Rectangular port.

67-16536 B/B ..... \$ 349.00 ea.

## INTAKE MANIFOLDS



### LS6/L78/L89 Intake Manifold

Original-style aluminum intake manifold with a low-profile design, and the correct "W" snowflake, Winters castings.

Replaces GM # 3963569. Rectangular port.  
67-16538 B/B ..... \$ 319.00 ea.

## INTAKE MANIFOLD BOLT KIT



Complete set of the correct intake manifold bolts. All feature the correct markings on the top of the heads.

67-16601 62-74 S/B ..... \$ 17.00 kit



67-16602 68-72 B/B w/cast iron intake . \$ 22.00 kit



Recessed head with raised "M", original for 1965-1967 motors.  
67-16603 65-67 B/B w/aluminum intake . \$ 16.00 kit

Flat top head with raised "M", original for 1968-1972 motors.  
68-16604 68-72 B/B w/aluminum intake . \$ 25.00 kit

## INTAKE MANIFOLD BOLT WASHER KIT



Complete set of zinc plated flat washers used under the intake manifold bolts. Though not original these washers are very helpful in protecting the aluminum.

67-16605 62-74 S/B ..... \$ 4.00 kit

+ The following items require additional shipping and handling.

# CHEVROLET NOVA PARTS



Car Shop Inc. 739 North Batavia Orange, California 92868

## INTAKE MANIFOLD GASKET SETS

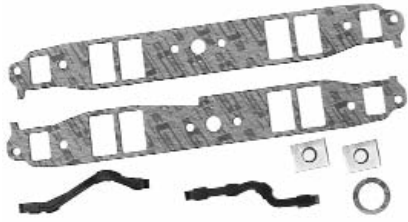

67-16606 62-74 S/B .....\$ 16.00 set

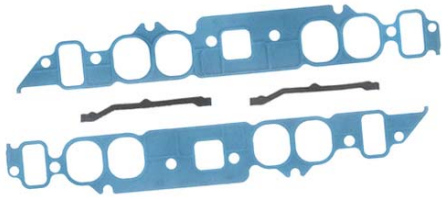

67-16607 68-72 B/B with oval port ....\$ 21.00 set



67-16608 68-72 B/B with rectangle port ..\$ 21.00 set

## ENGINE LIFT BRACKET KIT



These are the stamped steel brackets used when installing or removing your engine.

67-16609 64-70 S/B .....\$ 22.00 pr.



71-16610 71-81 S/B .....\$ 22.00 pr.



67-16611 68-72 B/B .....\$ 25.00 pr.



67-16612 64-81 Stud for brackets .....\$ 3.00 ea.

## CYLINDER HEAD BOLT KIT

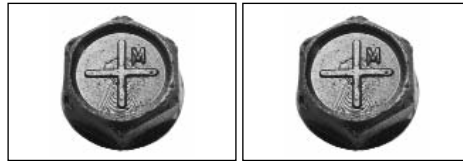

Original "M" headmark, (24) 7/16-14 x 4 1/8" bolts,  
(8) 7/16-14 x 2 1/8" bolts.

67-16613 68-72 B/B .....\$ 73.00 kit

## OIL PRESSURE SENDING UNIT



Oil pressure sending unit fits all cars with warning lights.

67-167031 62-74 reproduction .....\$ 7.00 ea.

67-16703 62-74 original AC Delco .....\$ 14.00 ea.

## TEMPERATURE SENDING UNIT



68-16615 63-64 with gauges  
68 with gauges .....\$ 25.00 ea.

67-16614 65 with gauges .....\$ 25.00 ea.



69-16616 69-75 with gauges .....\$ 25.00 ea.



67-16618 64-67 with warning light  
69-74 with warning light .....\$ 25.00 ea.

68-16618 68 with warning light .....\$ 25.00 ea.

## TEMPERATURE SENDING UNIT WIRE INSULATION

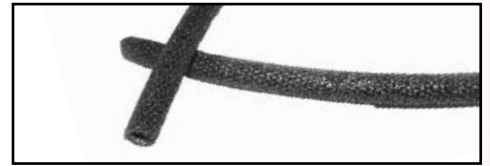

67-16701 62-74 insulation, 30" .....\$ 5.00 ea.

## TEMPERATURE SENDING UNIT WIRE & INSULATION



Temperature wire replacement kit. Includes 24" green wire with cloth insulator, and plastic end. Fits flat terminal or button head terminal.

67-16702 62-75 .....\$ 8.00 kit

Fits thin round terminal.

68-16702 63-64 with gauges  
68 with gauges .....\$ 13.00 kit

## FREEZE PLUG SETS



67-16704 64-74 S/B .....\$ 14.00 set

67-16705 69-72 B/B .....\$ 18.00 set

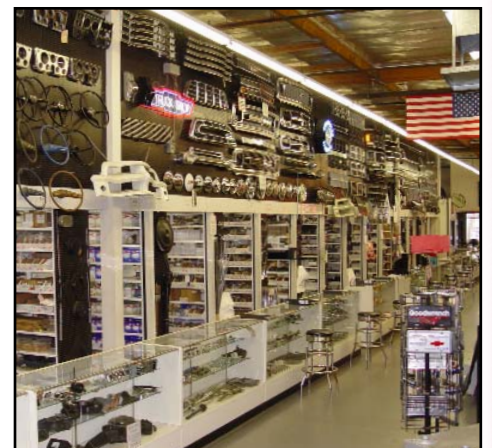

Just down the hall from Car Shop is Truck Shop.  
1947-91 Chevy & GMC truck parts.

+ The following items require additional shipping and handling.

Fax Order 1-714-771-0407 • Toll Free 1-800-235-2470 • [www.TruckandCarShop.com](http://www.TruckandCarShop.com) • 2014 Catalog



# CHEVROLET NOVA PARTS

Car Shop Inc. 739 North Batavia Orange, California 92868

## THERMOSTAT HOUSING (WATER NECK) V/8



58-07217 64-65 SB cast iron .....\$ 19.00 ea.  
63-07218 63-72 6 cylinder .....\$ 21.00 ea.



67-16706 66-73 replacement .....\$ 9.00 ea.



Features correct GM part number. (GM# 3877660)  
67-16707 66-73 Aluminum .....\$ 47.00 ea.



L79 Style, without GM part number.  
66-07221 66-68 Hi-Perf. cast iron .....\$ 25.00 ea.



L79 Style, features correct GM part number. (GM# 3827369)  
66-07221 66-68 Hi-Perf. cast iron .....\$ 69.00 ea.

## 360° SWIVEL THERMOSTAT HOUSING



Polished aluminum.  
67-16708 62-74 45° Outlet .....\$ 19.00 ea.  
67-16709 62-74 90° Outlet .....\$ 19.00 ea.

## THERMOSTAT HOUSING BOLTS



58-07221 64-65 SB .....\$ 1.50 pr.



Original "TR" headmark, for cast L79 style waterneck.  
67-16710 66-68 S/B .....\$ 5.00 pr.



69-16711 69-73 S/B .....\$ 8.00 pr.



Original "TR" headmark.  
69-16712 66-68 S/B .....\$ 6.00 pr.  
66-72 B/B .....\$ 6.00 pr.

## THERMOSTAT



Original Delco.  
67-16713 62-79 160° .....\$ 10.00 ea.  
67-16714 62-79 170° .....\$ 13.00 ea.  
67-16715 62-79 180° .....\$ 13.00 ea.

## THERMOSTAT HOUSING GASKETS



67-16716 62-79 Perma plus non-leak ...\$ 12.00 ea.



67-16717 62-79 with impregnated o-ring .....\$ 3.00 ea.



67-167171 62-79 standard .....\$ 3.00 ea.

## WATER PUMPS-CAST IRON



67-16801 62-72 4 or 6-cylinder .....\$ 35.00 ea.

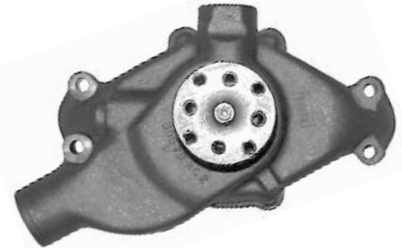

67-16802 64-68 S/B .....\$ 37.00 ea.

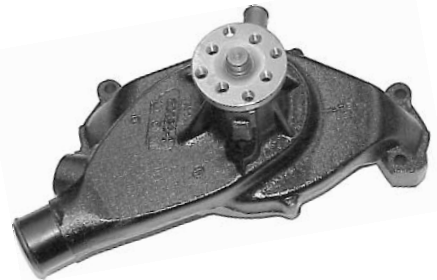

67-16803 68 B/B .....\$ 99.00 ea.



69-16804 69-76 S/B .....\$ 39.00 ea.



69-16805 69-72 B/B .....\$ 49.00 ea.

+ The following items require additional shipping and handling.

# CHEVROLET NOVA PARTS



Car Shop Inc. 739 North Batavia Orange, California 92868

## WATER PUMPS-ALUMINUM



Edelbrock Victor series performance water pumps.  
1964-68 used short style water pumps, 1969-74 used long pumps.  
67-16806 64-68 S/B, natural finish . . . . \$ 225.00 ea.



67-168061 64-68 S/B, polished . . . . . \$ 329.00 ea.  
67-168062 64-68 B/B, polished . . . . . \$ 365.00 ea.



Edelbrock Victor series performance water pumps.  
69-168063 69-76 S/B, polished . . . . . \$ 319.00 ea.  
69-168064 69-76 B/B, polished . . . . . \$ 365.00 ea.



RPC High Performance ultra-light aluminum water pumps.  
67-16807 64-68 S/B, natural finish . . . . \$ 109.00 ea.  
69-16807 69-76 S/B, natural finish . . . . \$ 134.00 ea.  
69-168071 69-72 B/B, natural finish . . . . \$ 148.00 ea.

## WATER PUMP REBUILD KITS



67-16808 64-68 S/B . . . . . \$ 58.00 kit  
67-16809 68 B/B . . . . . \$ 75.00 kit

## WATER PUMP BOLT KIT



67-16810 64-68 S/B TR bolts, 4 pc. . . . \$ 8.00 kit  
69-16811 69-74 S/B TR bolts, 4 pc. . . . \$ 8.00 kit



67-16812 68 B/B TR bolts, 4 pc. . . . \$ 8.00 kit  
69-16813 69-72 B/B TR bolts, 4 pc. . . . \$ 8.00 kit

## WATER PUMP BACKING PLATE BOLTS



Original "L" headmark, 1/4-20 x 1/2" bolt.  
67-16814 64-74 . . . . . \$ 1.50 ea.

## WATER PUMP PULLEYS



**Stock pulleys**  
Hi-perf. pulleys are deep groove.  
67-16815 64-68 S/B, without A/C 1 groove #3905995, 7 1/8" . . . . \$ 45.00 ea.  
67-16816 64-68 S/B, with A/C, 2 groove #3995642, 6 1/8" . . . . \$ 73.00 ea.  
67-16818 68 B/B, hi-perf. 2 groove #3906656 . . . . . \$ 99.00 ea.  
69-16819 69-70 B/B, hi-perf. 1 groove #3947824 BV . . . . . \$ 46.00 ea.

## REPLACEMENT WATER PUMP PULLEYS



**Chrome**  
Fits SB with short waterpump.  
67-16823 64-68 single groove . . . . . \$ 18.00 ea.  
67-16824 64-68 double groove . . . . . \$ 20.00 ea.

**Black**  
Fits SB with short waterpump.  
67-168231 64-68 single groove . . . . . \$ 17.00 ea.  
67-168241 64-68 double groove . . . . . \$ 19.00 ea.

**Chrome**  
Fits SB with long waterpump.  
69-16825 69-74 single groove . . . . . \$ 18.00 ea.  
69-16826 69-74 double groove . . . . . \$ 20.00 ea.

**Black**  
Fits SB with long waterpump.  
69-168251 69-74 single groove . . . . . \$ 17.00 ea.  
69-168261 69-74 double groove . . . . . \$ 19.00 ea.

## REPLACEMENT WATER PUMP PULLEYS



**Chrome**  
Fits BB with short waterpump.  
67-16901 double groove . . . . . \$ 22.00 ea.

**Black**  
Fits BB with short waterpump.  
67-169011 double groove . . . . . \$ 21.00 ea.

**Chrome**  
Fits BB with long waterpump.  
69-16902 double groove . . . . . \$ 22.00 ea.

**Black**  
Fits BB with long waterpump.  
69-169021 double groove . . . . . \$ 21.00 ea.

## WATER PUMP PULLEY REINFORCEMENT



This washer or spacer is for any model with the short water pump.  
67-169025 64-68 S/B . . . . . \$ 5.00 ea.

+ The following items require additional shipping and handling.

Fax Order 1-714-771-0407 • Toll Free 1-800-235-2470 • www.TruckandCarShop.com • 2014 Catalog



# CHEVROLET NOVA PARTS

Car Shop Inc. 739 North Batavia Orange, California 92868

## HEATER HOSE FITTINGS



Hose fittings, water pump & intake.

67-16903 62-74 S/B fittings .....\$ 15.00 pr.



Hose fittings, water pump & intake.

67-16904 69-70 B/B fittings .....\$ 15.00 pr.

## CHROME WATER PUMP/INTAKE FITTING



67-16905 Long .....\$ 8.00 ea.

67-16906 Short .....\$ 7.00 ea.

## BYPASS HOSE FITTINGS



67-16907 69-70 B/B .....\$ 15.00 pr.



67-16908 66-67 L-79 .....\$ 19.00 ea.

## INTAKE/WATER PUMP 1/2" PLUG



67-169091 1/2-14, raw .....\$ 1.00 ea.

67-169092 1/2-14, black coated .....\$ 3.75 ea.

## BYPASS HOSE CLAMPS



67-15217 3/4" side screw .....\$ 3.50 ea.

## WATER PUMP BYPASS HOSE



67-16910 66-67 S/B, L-79 .....\$ 11.00 ea.

## WATER PUMP BYPASS HOSE & CLAMP KIT



This kit fits Big Block applications with short water pump.

67-16912 68 B/B, with clamps .....\$ 13.00 kit



This kit fits Big Block applications with long water pump.

67-16913 69-70 B/B, with clamps .....\$ 9.00 kit

## V8 ENGINE BOLT KITS



Stainless steel engine bolt kits with indented hex head style bolts.

For stock style water pumps and steel valve covers.

67-17220 64-68 SB, (short pump) .....\$ 48.00 kit

69-17221 69-78 SB, (long pump) .....\$ 48.00 kit

67-17222 68 BB, (short pump) .....\$ 65.00 kit

69-17223 69-72 BB, (long pump) .....\$ 50.00 kit

For stock style water pumps and cast aluminum valve covers.

67-17226 64-68 SB, (short pump) .....\$ 51.00 kit

69-17227 69-78 SB, (long pump) .....\$ 48.00 kit

67-17228 68 BB, (short pump) .....\$ 50.00 kit

69-17229 69-72 BB, (long pump) .....\$ 50.00 kit

## 6 CYLINDER VALVE & SIDE COVER KIT



Fits 194, 230, 250 6-cylinder.

67-170022 62-74 Chrome, 3 pieces .....\$ 32.00 set

## CHROME SMALL BLOCK DRESS UP KIT



2 Valve Covers, 1 Timing Chain Cover, 1 Oil Breather, 1 Timing Pointer, 1 Breather Grommet, 1 Oil Dipstick and Tube, 1 PCV Grommet.

67-17003 SB, Chrome .....\$ 44.00 kit

## VALVE COVERS



## CHROME VALVE COVERS

67-17004 S/B, short with baffle .....\$ 25.00 pr.

67-17005 S/B, tall with baffle .....\$ 30.00 pr.



## EARLY STYLE VALVE COVERS

67-17006 64-67 S/B, orange .....\$ 105.00 pr.

67-17007 64-67 S/B, chrome .....\$ 124.00 pr.



# CHEVROLET NOVA PARTS



Car Shop Inc. 739 North Batavia Orange, California 92868

## VALVE COVERS



### "CHEVROLET" SCRIPT

Excellent reproductions of original "Chevrolet" script valve covers in chrome or ready to paint. Correct wire retainers, original factory quality chrome plating.

- 67-170071 64-67 S/B, primered . . . . . \$ 139.00 pr.
- 67-170072 64-67 S/B, chrome . . . . . \$ 179.00 pr.

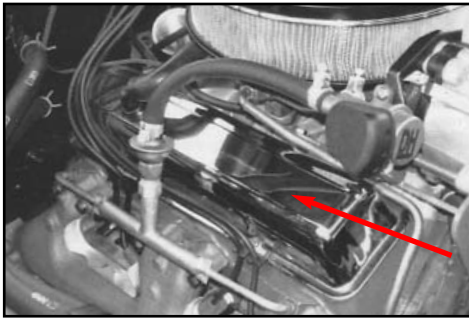

### SS 350 ORIGINAL STYLE

Excellent reproductions of original new design valve covers in chrome or ready to paint. Correct wire retainers and stamping mark, original factory quality chrome plating.

- 68-170071 68 S/B, primered . . . . . \$ 109.00 pr.
- 68-170072 68 S/B, chrome . . . . . \$ 159.00 pr.



### SMALL BLOCK LT-1 ALUMINUM VALVE COVERS

Z/28, LT-1, small block, cast with drippers.

Reproduction finned aluminum valve covers, includes gasket.

- 69-170082 69-72 LH, reproduction . . . . . \$ 139.00 ea.



- 69-170092 69-72 RH, reproduction . . . . . \$ 139.00 ea.



- 69-17010 69-72 RH X-flag emblem, GM \$ 9.00 ea.
- 69-170102 69-72 RH X-flag emblem, repro \$ 5.00 ea.

## VALVE COVERS



### CENTER BOLT VALVE COVERS

Features red Bow-tie & black Chevrolet letters.

Fits 1987 and newer small block heads.

With hardware.

- 67-17011 S/B, Polished aluminum . . . . . \$ 219.00 pr.
- 67-17012 S/B, Chromed aluminum . . . . . \$ 299.00 pr.



### "OFFENHAUSER"

- 67-17013 S/B Polished aluminum . . . . . \$ 299.00 pr.



### ALUMINUM CHEVROLET VALVE COVERS

Features red Bow-tie & black Chevrolet letters.

Small block cast with drippers

- 67-17014 polished aluminum . . . . . \$ 179.00 pr.
- 67-170141 chrome . . . . . \$ 319.00 pr.



### ALUMINUM CHEVROLET VALVE COVERS

Small block cast with drippers

- 67-17015 black powder coated . . . . . \$ 179.00 pr.

## VALVE COVERS



### COMPETITION ALUMINUM VALVE COVERS

Cast aluminum "Bow-Tie" valve covers for Chevy small block V8's.

- 67-17016 S/B, Raw finish . . . . . \$ 276.00 pr.
- 67-170161 S/B, black . . . . . \$ 276.00 pr.
- 67-170162 S/B, polished . . . . . \$ 295.00 pr.
- 67-170163 S/B, chrome . . . . . \$ 375.00 pr.



### POLISHED ALUMINUM

- 67-17101 S/B, Ball milled, short . . . . . \$ 59.00 pr.
- 67-17102 S/B, Ball milled, tall . . . . . \$ 65.00 pr.



### POLISHED ALUMINUM

- 67-17103 S/B, With flames, short . . . . . \$ 59.00 pr.
- 67-17104 S/B, With flames, tall . . . . . \$ 65.00 pr.



### REPRODUCTION OF BIG BLOCK VALVE COVERS

Features correct dimples, grommet holes and plug retainers tabs.

- 67-17105 68-72 B/B With drippers . . . . . \$ 109.00 pr.

+ The following items require additional shipping and handling.

Fax Order 1-714-771-0407 • Toll Free 1-800-235-2470 • [www.TruckandCarShop.com](http://www.TruckandCarShop.com) • 2014 Catalog



# CHEVROLET NOVA PARTS

Car Shop Inc. 739 North Batavia Orange, California 92868

## VALVE COVERS



### CHROME

- 67-17106 B/B, short with baffle ..... \$ 30.00 pr.  
 67-17107 B/B, tall with baffle ..... \$ 35.00 pr.



### COMPETITION ALUMINUM VALVE COVERS

- 67-17108 B/B, Raw Aluminum ..... \$ 399.00 pr.



### COMPETITION ALUMINUM VALVE COVERS

- 67-17109 B/B, Black powder coated ..... \$ 439.00 pr.



### COMPETITION ALUMINUM VALVE COVERS

- 67-17110 B/B, Orange powder coated ..... \$ 429.00 pr.

## VALVE COVERS



### ALUMINUM CHEVROLET VALVE COVERS

- 67-17111 B/B black, with hardware ..... \$ 192.00 pr.



### "OFFENHAUSER"

- 67-17112 B/B, polished ..... \$ 299.00 pr.

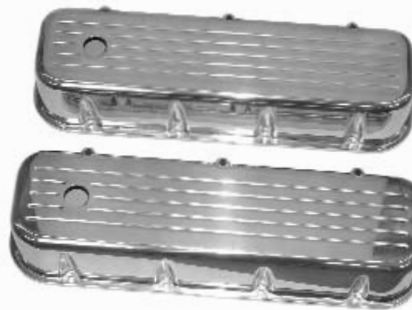

### POLISHED ALUMINUM

- Show Polished  
 67-17113 B/B, Ball milled ..... \$ 99.00 pr.



### POLISHED ALUMINUM

- Show Polished  
 67-17114 B/B, With flames ..... \$ 99.00 pr.

## VALVE COVER GASKETS



Fits 194, 230, 250 6-cylinder.

- 67-172061 62-74 inline 6, cork ..... \$ 12.00 ea.



- 67-17206 62-78 S/B, cork ..... \$ 14.00 pr.  
 67-17207 62-78 S/B, rubber ..... \$ 15.00 pr.

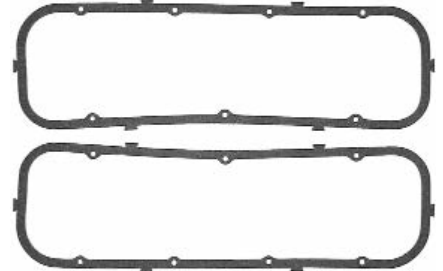

- 67-17208 68-72 B/B, cork ..... \$ 16.00 pr.  
 67-17209 68-72 B/B, Silver cork ..... \$ 18.00 pr.

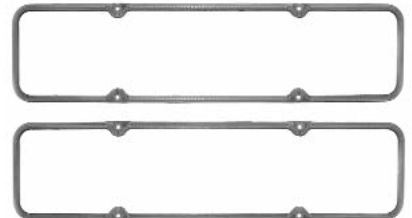

### "Perma-Plus" Fel-Pro Valve Cover Gaskets

- 67-17210 62-74 S/B ..... \$ 39.00 pr.  
 67-17211 68-72 B/B ..... \$ 57.00 pr.

## ENGINE SIDE COVER GASKET

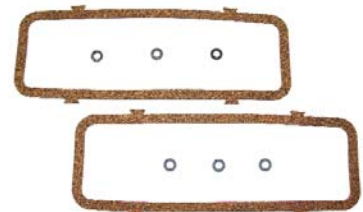

Fits 194, 230, 250 6-cylinder.

- 67-17230 62-74 inline-6, cork ..... \$ 12.00 kit  
 67-172301 62-74 inline-6, rubber ..... \$ 13.00 kit

+ The following items require additional shipping and handling.

# CHEVROLET NOVA PARTS



Car Shop Inc. 739 North Batavia Orange, California 92868

## CYLINDER HEAD GASKETS

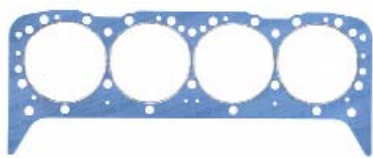

- 67-17240 64-74 283,327,350 .....\$ 21.00 ea.  
 67-17241 68-72 396,427,454 .....\$ 25.00 ea.

## CHROME VALVE COVER HOLD-DOWN TABS



- 67-17201 1 1/2" Wide .....\$ 1.00 ea.



- 67-17202 3" Wide .....\$ 2.00 ea.

## VALVE COVER RETAINERS WITH BOLTS



Complete set of zinc-plated retainers and zinc-plated bolts with the correct "TR" headmark, 8 retainers and 8 bolts.

- 67-17203 64-81 S/B .....\$ 13.00 kit

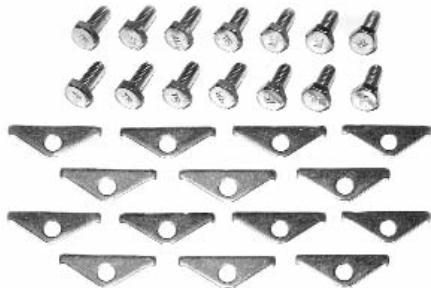

Complete set of zinc-plated retainers and zinc-plated bolts with the correct "TR" headmark, 14 retainers and 14 bolts.

- 67-17204 68-72 B/B .....\$ 18.00 kit



With "RWB" headmark.

- 67-172041 68-72 B/B, 14 bolts .....\$ 17.00 kit

## FINNED ALUMINUM VALVE COVER BOLT KIT



Longer bolts to accommodate the thicker cover. Correct "M" headmark for "GM" aluminum covers.

- 69-17205 69-72 8 pc. set, S/B .....\$ 10.00 set

## CRANK CASE VENT TUBE MOUNTING KIT



- 67-17212 64-67 S/B .....\$ 4.00 kit



- 67-17213 64-67 S/B, with hose .....\$ 8.00 kit

## CRANK CASE VENT TUBE



- 64-12935 64-65 327/250-300 hp .....\$ 52.00 ea.



- 64-12936 65 327/350 hp .....\$ 52.00 ea.



- 64-12937 66-67 327/350 hp .....\$ 52.00 ea.



- 67-17214 67 327/325 hp, with spark plug wire stand .....\$ 118.00 ea.

## CRANK CASE VENT TUBE INTAKE STUD



- 67-17216 64-67 S/B .....\$ 3.00 ea.

## OIL FILLER TUBES, O.E.



- 64-129082 64-65 Tube, chrome .....\$ 36.00 ea.  
 64-129081 64-65 Tube, black .....\$ 26.00 ea.



- 67-17301 66-67 Tube, chrome .....\$ 39.00 ea.  
 67-17302 66-67 Tube, black .....\$ 37.00 ea.



- 68-17303 68 Tube, chrome .....\$ 40.00 ea.  
 68-17304 68 Tube, black .....\$ 34.00 ea.

## OIL FILLER TUBES, REPLACEMENT



Requires push on style breather cap.

- 67-17305 64-67 Tube, argent silver .....\$ 17.00 ea.  
 67-17306 64-67 Tube, chrome .....\$ 6.00 ea.

Black with return spring tab, requires push on style breather cap.

- 67-173061 64-67 Tube, black .....\$ 25.00 ea.

+ The following items require additional shipping and handling.



# CHEVROLET NOVA PARTS

Car Shop Inc. 739 North Batavia Orange, California 92868

## OIL FILLER CAPS



- 64-129091 64-65 S/B, chrome with gasket .....\$ 10.00 ea.  
 64-129092 64-65 oil cap gasket .....\$ 1.00 ea.



- With correct "S" rivet.  
 67-17307 66-68 S/B, chrome .....\$ 16.00 ea.  
 67-17308 66-68 S/B, black .....\$ 10.00 ea.



- Push on style, fits replacement oil fill tubes.  
 67-17309 64-67 Black, "Oil / Oil" .....\$ 22.00 ea.



- 67-17310 64-67 Silver zinc, no logo ...\$ 6.00 ea.



- 67-17311 64-69 6-cylinder, zinc .....\$ 6.00 ea.



- With correct "S" rivet and "SM" logo.  
 67-17312 68 B/B, black .....\$ 35.00 ea.  
 67-17313 68-72 B/B, chrome .....\$ 16.00 ea.  
 69-17313 69-74 LT-1 .....\$ 16.00 ea.

## OIL FILLER CAPS



- GM replacement.  
 67-17315 68-78 Chrome with "Oil Fill" insert .....\$ 14.00 ea.

## OIL FILLER PLUGS



- 71-17401 71-79 Rubber plug, "OIL" ....\$ 3.00 ea.



- 67-17402 Aluminum .....\$ 17.00 ea.

## CHROME BREATHER CAPS, UNIVERSAL



- 67-17403 Push in .....\$ 6.00 ea.



- 67-17404 Push in with vent tube .....\$ 6.00 ea.



- 67-17405 Push in with small neck ....\$ 6.00 ea.



- 67-17407 Push in-washable filter .....\$ 12.00 ea.  
 67-174071 Push in-washable filter with chrome shield .....\$ 11.00 ea.

## ALUMINUM BREATHER CAPS, UNIVERSAL



- Polished aluminum  
 67-17408 Ball milled top .....\$ 18.00 ea.  
 67-17409 Smooth top .....\$ 18.00 ea.



- 67-17410 Ball milled, with pcv valve ....\$ 19.00 ea.  
 67-17411 Smooth, with pcv valve .....\$ 19.00 ea.



- 67-17412 With flames .....\$ 18.00 ea.  
 67-17413 With flames, with pcv valve ..\$ 19.00 ea.

## PCV VALVE HOSE



- Correct thick-walled hose for all 68-72 applications. Trimming may be required for some applications.  
 68-17414 68-81 PCV Valve hose .....\$ 11.00 ea.

## PCV VALVE



- 67-17415 66-67 Screw in .....\$ 7.00 ea.  
 68-17416 68-78 .....\$ 4.00 ea.



- Aluminum PCV Valve.  
 67-17417 68-78 Universal .....\$ 12.00 ea.

# CHEVROLET NOVA PARTS



Car Shop Inc. 739 North Batavia Orange, California 92868

## PCV VALVE HOSE RETAINER CLIP



68-17418 68-81 S/B .....\$ 17.00 ea.



67-17419 68-72 B/B .....\$ 15.00 ea.

## PCV VALVE HOSE CLAMP



Correct style Black pinch clamp. Also fits power brake hose.

67-17420 66-74 PCV valve hose clamp . . \$ 1.00 ea.

## VALVE COVER ELBOW CONNECTOR



This is the elbow connector that fits into the grommet on the RH valve cover. Molded hose runs from this connector to the lower tube on the air cleaner base.

68-17421 68-73 S/B .....\$ 8.00 ea.



67-17422 68-72 B/B .....\$ 10.00 ea.

## VALVE COVER-TO-AIR CLEANER MOLDED HOSE



68-17502 68-72 S/B .....\$ 13.00 ea.



67-17503 68-72 B/B .....\$ 6.00 ea.

## VALVE COVER GROMMETS



Small block vent elbow or PCV valve, small I.D.

68-17504 68-72 Small hole .....\$ 2.00 ea.

Big block vent elbow or push in breathers, large I.D.

67-17505 68-72 Large hole .....\$ 2.00 ea.



Fits Z/28, LT1 type finned aluminum valve covers.

69-17506 69-72 .....\$ 3.00 ea.

## V8 OIL PAN CONVERSION KIT



Includes: V8 oil pan (front sump), oil pan gasket set, oil drain plug & seal, oil pump, oil pump shaft, oil pump pick up with screen, dip stick & dip stick tube.

62-17519 62-67 .....\$ 309.00 kit

Oil pan conversion kit with V8 engine mounting brackets.

62-17520 62-67 with V8 brackets .....\$ 379.00 kit

## OIL PANS



### 1962-1967 front sump oil pans

Stamped reproduction of stock oil pan. Fits 1979 & older V8 blocks.

Includes oil pan gasket set, oil drain plug & drain plug seal.

62-17521 62-67 S/B, 5 qt. ....\$ 149.00 ea.

## OIL PANS



Large capacity oil pans, Fits 1979 & older V8 blocks.

62-175211 62-67 S/B, 6 qt. ....\$ 239.00 ea.

62-175212 62-67 S/B, 7 qt. ....\$ 239.00 ea.

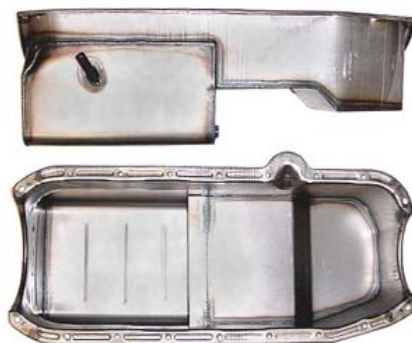

Front sump oil pan, Fits 1980-85 RH dip stick V8 blocks.

62-175213 62-67 S/B, 5 qt. ....\$ 209.00 ea.



Front sump oil pans, Fits 1986 & newer V8 blocks with 1-piece rear main seal.

62-175214 62-67 S/B, 5 qt. ....\$ 209.00 ea.

62-175215 62-67 S/B, 6 qt. ....\$ 209.00 ea.

62-175216 62-67 S/B, 7 qt. ....\$ 239.00 ea.

+ The following items require additional shipping and handling.



# CHEVROLET NOVA PARTS

Car Shop Inc. 739 North Batavia Orange, California 92868

## OIL PANS



### 1962-1967 rear sump oil pans

Large capacity oil pans, Fits 1979 & older V8 blocks.

Rear sump with cut-out, will not work with power steering.  
Has clearance for street driven Novas.

62-175216 62-67 S/B, 7 qt. .... \$ 209.00 ea.

Fits 1980-85 RH dip stick V8 blocks.

62-175217 62-67 S/B, 7 qt. .... \$ 209.00 ea.

Fits 1986 & newer V8 blocks with 1-piece rear main seal.

62-175218 62-67 S/B, 7 qt. .... \$ 209.00 ea.



### Steel reproduction oil pans

67-17521 68-78 S/B, reproduction .... \$ 35.00 ea.

67-175211 68-78 S/B, orange .... \$ 40.00 ea.

67-17516 68-78 S/B, chrome .... \$ 45.00 ea.

For 1980-87 engines, dipstick is on the passenger side.

67-175212 80-85 S/B, black .... \$ 40.00 ea.

67-175213 86-87 S/B, black  
1-pc rear seal type .... \$ 44.00 ea.



### Steel Claimer Style Oil Pan

Made with thicker material, 2 trap doors, crank scraper with windage tray,  
and reinforced rails, must use pickup # 67-176082

67-17525 68-78 S/B ..... \$ 69.00 ea.

## OIL PANS



### Steel reproduction oil pans

67-17522 68-72 B/B, bare .... \$ 40.00 ea.

67-175221 68-72 B/B, black .... \$ 45.00 ea.

67-17517 68-72 B/B, chrome .... \$ 49.00 ea.



### Polished Aluminum Oil Pan

67-17523 68-72 S/B ..... \$ 65.00 ea.

## OIL PAN GASKET SET



67-17512 62-78 S/B ..... \$ 18.00 ea.

67-17513 68-72 B/B ..... \$ 25.00 ea.

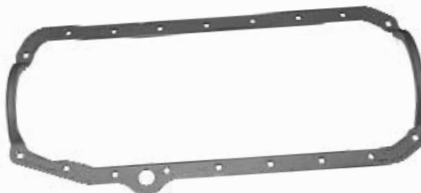

Perma Plus non-leak design

67-17514 62-78 S/B, 1 piece .... \$ 39.00 ea.

67-17515 68-72 B/B, 1 piece .... \$ 49.00 ea.

## OIL PAN BOLT KIT



67-17601 62-78 S/B ..... \$ 8.00 kit

## OIL PAN BOLT KIT



67-17602 68-72 B/B ..... \$ 13.00 kit

## OIL PAN DRAIN PLUG



GM improved design magnetic oil drain plug.

67-17603 62-78 magnetic drain plug ... \$ 21.00 ea.

GM improved design oil drain plug gasket.

67-17604 62-78 drain plug seal ..... \$ 4.00 ea.



Standard drain plug & gasket.

67-176031 62-78 ..... \$ 3.00 ea.



Chrome magnetic drain plug with plastic gasket

67-176032 62-78 ..... \$ 5.00 ea.

## OIL PAN BAFFLE



62-17605 62-67 S/B ..... \$ 84.00 ea.



67-17605 68-72 S/B, Hi-performance ... \$ 41.00 ea.



68-17607 68-72 Mounting studs,  
5 required ..... \$ 6.00 ea.

# CHEVROLET NOVA PARTS



Car Shop Inc. 739 North Batavia Orange, California 92868

## MAIN CAP BOLT WITH STUD



For front sump pick-up tube, fits 350 2 & 4 bolt main, creates anchor point for pick-up tube.

62-17607 62-67 .....\$ 8.50 ea.

## OIL PUMP PICK-UP & SCREEN



62-17608 62-67 S/B, front sump .....\$ 29.00 ea.



For use with custom rear sump oil pans with cut out.

62-176082 62-67 S/B .....\$ 42.00 ea.



67-17608 68-78 S/B, original GM .....\$ 19.00 ea.

67-176083 68-78 S/B, import .....\$ 12.00 ea.

67-176081 68-72 B/B, original GM .....\$ 20.00 ea.

67-176084 68-72 B/B, import .....\$ 12.00 ea.



For use with steel claimer style oil pan # 67-17525.

67-176082 68-78 S/B, claimer style .....\$ 19.00 ea.

## OIL PUMP DRIVE SHAFT



62-176095 62-67 S/B .....\$ 13.00 ea.



67-176095 68-81 S/B .....\$ 16.00 ea.

## HI-VOLUME OIL PUMP



62-17609 62-67 S/B .....\$ 112.00 ea.



67-17609 68-78 S/B, original GM .....\$ 108.00 ea.

67-176091 68-78 S/B, replacement .....\$ 65.00 ea.

67-176092 68-72 B/B .....\$ 78.00 ea.

## OIL PUMP BOLT



Oil pump to rear main cap attaching bolt.  
Original "Double circle" headmark, 7/16-14 x 2"

67-17610 62-81 S/B .....\$ 3.75 ea.

## OIL FILTER BYPASS VALVE



67-17611 64-67 with gasket & bolts .....\$ 32.00 ea.

67-17612 64-67 Gasket only .....\$ 3.00 ea.



68-17613 68-78 .....\$ 43.00 ea.

## OIL FILTER BYPASS VALVE BOLTS



Original "Delta" headmark, 1/4-20 x 1 1/4", grade 5.

67-17614 64-67 .....\$ 2.50 pr.



68-17614 68-78 .....\$ 1.50 ea.

## OIL FILTERS



67-17615 64-67 Element & seal .....\$ 7.00 ea.



68-17616 68-78 Blue replacement, short .....\$ 7.00 ea.

68-17617 68-78 Blue replacement, tall .....\$ 7.00 ea.



Correct white A/C delco filter.

68-17618 68-71 "AC" PF-25, short .....\$ 24.00 ea.

68-176181 68-71 "AC" PF-35, tall .....\$ 24.00 ea.

## OIL FILTER ADAPTER KIT

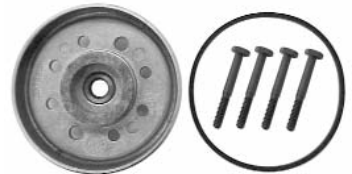

Adapts to 1968 & newer, spin on filter. Must use original bypass valve.

67-17619 64-67 .....\$ 26.00 kit

## OIL FILTER CANISTER



New canister with black electrostatic powder paint & correct white silk screen. Includes oil filter & gasket.

67-17701 64-67 .....\$ 94.00 ea.

\* The following items require additional shipping and handling.

Fax Order 1-714-771-0407 • Toll Free 1-800-235-2470 • [www.TruckandCarShop.com](http://www.TruckandCarShop.com) • 2014 Catalog





# CHEVROLET NOVA PARTS

Car Shop Inc. 739 North Batavia Orange, California 92868



## OIL DIP STICK TUBE

- |   |           |       |             |         |       |     |
|---|-----------|-------|-------------|---------|-------|-----|
|  | 67-17702  | 64-69 | 6-cylinder  | .....\$ | 12.00 | ea. |
|   | 62-17703  | 62-67 | S/B, in pan | .....\$ | 16.00 | ea. |
|  | 67-17703  | 68-78 | S/B, outer  | .....\$ | 18.00 | ea. |
|  | 67-177032 | 68-78 | S/B, inner  | .....\$ | 13.00 | ea. |
|   | 68-17705  | 68-72 | B/B         | .....\$ | 39.00 | ea. |



## OIL LEVEL DIP STICK

- |  |          |       |             |         |       |     |
|--|----------|-------|-------------|---------|-------|-----|
|  | 62-17708 | 62-67 | S/B, in pan | .....\$ | 15.00 | ea. |
|  | 68-17708 | 68-72 | B/B         | .....\$ | 17.00 | ea. |

## ORIGINAL STYLE ENGINE OIL DIPSTICK AND TUBE

- |  |           |       |             |         |       |     |
|--|-----------|-------|-------------|---------|-------|-----|
|  | 67-177031 | 68-78 | Small block | .....\$ | 20.00 | pr. |
|  | 68-177051 | 68-87 | Big block   | .....\$ | 38.00 | pr. |
- Correct for 1968-1972, replacement for some years.

## CHROME ENGINE OIL DIPSTICK AND TUBE

- |  |          |       |         |         |       |     |
|--|----------|-------|---------|---------|-------|-----|
|  | 67-17709 | 68-78 | S/B, V8 | .....\$ | 8.00  | ea. |
|  | 67-17710 | 68-72 | B/B V-8 | .....\$ | 10.00 | ea. |

## STAINLESS BRAIDED ENGINE OIL DIPSTICK AND TUBE



- |  |           |       |         |         |       |     |
|--|-----------|-------|---------|---------|-------|-----|
|  | 67-177102 | 68-78 | S/B V-8 | .....\$ | 38.00 | ea. |
|--|-----------|-------|---------|---------|-------|-----|

## ENGINE OIL DIPSTICK DELETE PLUG

- |   |           |       |            |         |      |     |
|---|-----------|-------|------------|---------|------|-----|
|  | 62-177105 | 62-67 | 7/16" O.D. | .....\$ | 3.50 | ea. |
|   | 62-177106 | 62-67 | 3/8" O.D.  | .....\$ | 3.50 | ea. |

## TIMING CHAIN COVER POINTER, O.E.

- |   |          |       |     |         |       |     |
|---|----------|-------|-----|---------|-------|-----|
|  | 67-17711 | 64-69 | S/B | .....\$ | 18.00 | ea. |
|---|----------|-------|-----|---------|-------|-----|
- Correct timing tab, must be welded to cover.  
All S/B without 8" balancer

- |   |           |       |     |         |       |     |
|---|-----------|-------|-----|---------|-------|-----|
|  | 64-132132 | 64-65 | S/B | .....\$ | 18.00 | ea. |
|  | 67-17712  | 66-69 | S/B | .....\$ | 18.00 | ea. |
|   | 67-17713  | 68-69 | B/B | .....\$ | 18.00 | ea. |
- All Hi-perf. engines equipped with 8" balancer

## CHROME TIMING CHAIN COVER POINTER

- |   |          |       |                                 |       |      |     |
|---|----------|-------|---------------------------------|-------|------|-----|
|  | 67-17803 | 64-78 | S/B, with 6" or 6 3/4" balancer | ...\$ | 5.00 | ea. |
|   | 67-17804 | 64-78 | S/B, with 8" balancer           | ...\$ | 4.00 | ea. |
|   | 67-17805 | 68-72 | B/B, with 8" balancer           | ...\$ | 4.00 | ea. |

## TIMING CHAIN COVERS, O.E.



Features correct timing tab welded to cover, Fits 1955-87 engines.  
All S/B without 8" balancer.

- |          |       |     |         |       |     |
|----------|-------|-----|---------|-------|-----|
| 67-17714 | 64-69 | S/B | .....\$ | 68.00 | ea. |
|----------|-------|-----|---------|-------|-----|



All S/B Hi-perf. engines equipped with 8" balancer

- |          |       |     |         |       |     |
|----------|-------|-----|---------|-------|-----|
| 64-17715 | 64-65 | S/B | .....\$ | 68.00 | ea. |
| 67-17715 | 66-69 | S/B | .....\$ | 68.00 | ea. |

## TIMING CHAIN COVER, REPLACEMENT



Bare steel, no timing tab.

|          |       |     |         |       |     |
|----------|-------|-----|---------|-------|-----|
| 67-17716 | 64-78 | S/B | .....\$ | 14.00 | ea. |
|----------|-------|-----|---------|-------|-----|

Chrome, no timing tab.

|          |       |             |         |       |     |
|----------|-------|-------------|---------|-------|-----|
| 67-17801 | 64-78 | S/B, chrome | .....\$ | 16.00 | ea. |
|----------|-------|-------------|---------|-------|-----|



# CHEVROLET NOVA PARTS



Car Shop Inc. 739 North Batavia Orange, California 92868

## TIMING CHAIN COVER, REPLACEMENT



67-17802 68-72 B/B, V8, chrome .....\$ 20.00 ea.

## TIMING CHAIN COVER BOLT KIT



67-17806 64-78 All, 10 pc. ....\$ 7.00 kit

## TIMING COVER AND FRONT PAN GASKET SET

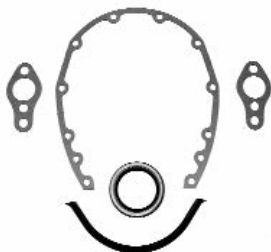

67-17807 64-78 S/B .....\$ 16.00 set



67-17808 68-72 B/B .....\$ 19.00 set

## HARMONIC BALANCER BOLT KIT



Includes 1 bolt and 2 washers.

Original "Delta" headmark, 7/16-20 x 2 1/4", grade 5.

67-17809 64-78 S/B .....\$ 10.00 kit



Original "Delta" headmark, 1/2-20 x 1 1/2", grade 5.

67-17810 68-72 B/B .....\$ 10.00 kit

## HARMONIC BALANCER



"Professional Products" Powerforce balancer.

67-178111 64-68 283 & 327  
68 307, 6" .....\$ 89.00 ea.



"Professional Products" replacement balancers

69-17813 69-78 350 Exc. Hi-perf., 6 3/4" . \$ 69.00 ea.  
69-17814 69-78 350 Hi-perf., 8" .....\$ 95.00 ea.



"Professional Products" polished stainless Powerforce balancer.

69-178142 69-78 350, 8" .....\$ 290.00 ea.



For use on externally balanced 383 or 400 small block Chevy engines.

69-178143 69-78 383, 400 Hi-Perf., 8" . . . \$ 106.00 ea.



"Professional Products" replacement balancers

67-178151 68-72 396,427, 8" .....\$ 115.00 ea.

67-17816 68-72 454, 502  
Includes counterweight . . \$ 127.00 ea.

67-17817 68-72 counterweight,  
for 454, 502 .....\$ 12.00 ea.

## HARMONIC BALANCER CHROME COVERS



67-178102 S/B, 6 3/4" .....\$ 38.00 ea.  
67-178103 S/B, 8" .....\$ 38.00 ea.  
67-178104 B/B, 8" .....\$ 38.00 ea.

## CRANK SHAFT PULLEY



67-17901 64-68 S/B, 1 groove, 6 3/4"  
#3755820 .....\$ 39.00 ea.



67-17902 64-68 S/B, 2 groove, 6 3/4"  
#3744043 .....\$ 44.00 ea.



Add to non-power steering original pulley, for power steering.

67-17904 64-68 S/B, 1 groove, 6 3/4"  
#3751232 .....\$ 46.00 ea.

67-17905 68 B/B, 1 groove, 6 3/4" . . . \$ 55.00 ea.



67-179061 68 B/B, 1 groove .....\$ 39.00 ea.

→ The following items require additional shipping and handling.

Fax Order 1-714-771-0407 • Toll Free 1-800-235-2470 • [www.TruckandCarShop.com](http://www.TruckandCarShop.com) • 2014 Catalog



# CHEVROLET NOVA PARTS

Car Shop Inc. 739 North Batavia Orange, California 92868

## CRANK SHAFT PULLEY



- 69-17908 69-78 S/B, 2 groove 6 3/4" #14023147 ..... \$ 54.00 ea.
- 69-17910 69-78 Small block, 3 groove, 6 3/4", 3rd groove=7 3/4" #3972180 ..... \$ 75.00 ea.
- 69-17911 69-72 Big block, 2 groove deep, 6 3/4" #3955291 AB ..... \$ 85.00 ea.
- 69-179111 69-72 Big block, with AC 3 groove, 7 5/8" #3937787 AC ..... \$ 75.00 ea.

## CRANK SHAFT PULLEY BOLT KIT



Includes 3 bolts and 3 lock washers.  
Original "S" headmark, 3/8-24 x 5/8".

- 67-17912 64-68 S/B ..... \$ 7.00 kit

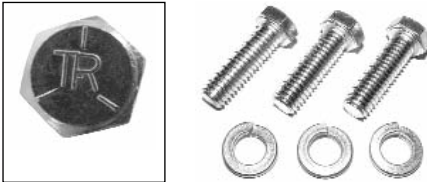

Original "TR" headmark, 3/8-16 x 1 1/4".

- 67-17913 68-72 B/B ..... \$ 5.00 kit

## REPLACEMENT CRANKSHAFT PULLEYS



- Chrome**  
Fits SB with short waterpump.
- 67-17914 64-68 single groove, 6 3/4" ... \$ 20.00 ea.
  - 67-17915 64-68 double groove, 7 1/4" ... \$ 25.00 ea.
  - 67-17916 64-68 triple groove, 7 1/4" 2-piece pulley ..... \$ 43.00 ea.

- Black**  
Fits SB with short waterpump.
- 67-179141 64-68 single groove, 6 3/4" ... \$ 19.00 ea.
  - 67-179151 64-68 double groove, 7 1/4" ... \$ 24.00 ea.

## REPLACEMENT CRANKSHAFT PULLEYS



- Chrome**  
Fits SB with long waterpump.
- 69-17917 69-74 single groove, 6 3/4" ... \$ 27.00 ea.
  - 69-17918 69-74 double groove, 6 3/4" ... \$ 28.00 ea.
  - 69-17919 69-74 triple groove, 7 3/4" ... \$ 32.00 ea.

- Black**  
Fits SB with long waterpump.
- 69-179171 69-74 single groove, 6 3/4" ... \$ 26.00 ea.
  - 69-179181 69-74 double groove, 6 3/4" ... \$ 27.00 ea.
  - 69-179191 69-74 triple groove, 7 3/4" ... \$ 31.00 ea.



- Chrome**  
Fits BB with short waterpump.
- 67-17920 68 double groove, 7 3/4" ... \$ 25.00 ea.
  - 67-17921 68 add to above to make triple, 6 3/4" ... \$ 23.00 ea.

- Black**  
Fits BB with short waterpump.
- 67-179201 68 double groove, 7 3/4" ... \$ 24.00 ea.
  - 67-179211 68 add to above to make triple, 6 3/4" ... \$ 22.00 ea.



- Chrome**  
Fits BB with long waterpump.
- 69-17922 69-72 triple groove, 7 3/4" ... \$ 32.00 ea.



- Black**  
Fits BB with long waterpump.
- 69-179221 69-72 triple groove, 7 3/4" ... \$ 31.00 ea.

## AUTOMATIC TRANSMISSION PAN BOLTS



5/16-18 x 5/8, 1/2 hex.

- 67-180119 62-72 14 pieces ..... \$ 8.00 set

## TRANSMISSION OIL PANS



- 67-18001 63-70 Powerglide, chrome ... \$ 23.00 ea.
- 67-180011 63-70 Powerglide, black .... \$ 20.00 ea.



- 67-18002 67-78 TH350, chrome ..... \$ 23.00 ea.
- 67-180021 67-78 TH350, black ..... \$ 20.00 ea.



- 67-18003 68-78 TH400, chrome ..... \$ 22.00 ea.
- 67-180031 68-78 TH400, black ..... \$ 20.00 ea.



- 67-18004 TH700R4, chrome ..... \$ 25.00 ea.
- 67-180041 TH700R4, black ..... \$ 22.00 ea.

+ The following items require additional shipping and handling.

# CHEVROLET NOVA PARTS



Car Shop Inc. 739 North Batavia Orange, California 92868

## POLISHED ALUMINUM TRANSMISSION PANS



67-18005 67-81 TH350 .....\$ 49.00 ea.



67-18006 68-78 TH400 .....\$ 50.00 ea.



67-180061 TH700R4 .....\$ 55.00 ea.

## "GM" TRANSMISSION PAN TH400



67-18007 68-78 TH400, shallow .....\$ 89.00 ea.

67-180071 68-78 TH400, deep .....\$ 88.00 ea.

## TRANSMISSION OIL FILTER KIT



Filter & gasket kit.

67-180082 62-70 Powerglide .....\$ 11.00 kit

67-180092 67-78 TH350 .....\$ 12.00 kit

67-180102 68-78 TH400 .....\$ 15.00 kit

## TRANSMISSION OIL PAN GASKET



67-18008 62-70 Powerglide .....\$ 7.00 ea.

67-18009 67-78 TH350 .....\$ 8.00 ea.

67-18010 68-78 TH400 .....\$ 9.00 ea.

67-18011 68-78 TH700R4 .....\$ 10.00 ea.

## TRANSMISSION VACUUM MODULATOR



67-180115 64-70 Powerglide .....\$ 16.00 ea.

## TRANSMISSION COOLER LINE SETS



### ORIGINAL MATERIAL

66-18012+ 66-67 Powerglide, w/o spacer ..\$ 42.00 set

66-18013+ 66-67 Powerglide, with radiator spacer .....\$ 42.00 set

62-18014+ 62-67 TH350/400 .....\$ 42.00 set

62-18015+ 62-67 TH700R4 .....\$ 42.00 set

68-18014+ 68-72 TH350/400, with 12" span between ports .....\$ 42.00 set

68-18015+ 68-73 TH350/400, with 8" span between ports .....\$ 42.00 set

74-18014+ 74 TH350 .....\$ 42.00 set

### STAINLESS STEEL

66-18016+ 66-67 Powerglide, w/o spacer ..\$ 69.00 set

66-18017+ 66-67 Powerglide, with radiator spacer .....\$ 69.00 set

62-18018+ 62-67 TH350/400 .....\$ 69.00 set

62-18019+ 62-67 TH700R4 .....\$ 69.00 set

68-18018+ 68-72 TH350/400, with 12" span between ports .....\$ 69.00 set

68-18019+ 68-73 TH350/400, with 8" span between ports .....\$ 69.00 set

74-18018+ 74 TH350 .....\$ 69.00 set

## TRANSMISSION COOLER LINE CLIPS



67-18024 62-78 2 clip set .....\$ 3.00 pr.

## TRANSMISSION VACUUM MODULATOR LINES



### ORIGINAL MATERIAL

67-18025 67-69 Powerglide .....\$ 25.00 ea.

67-18026 68-72 TH350, Modulator mounted on left side ..\$ 25.00 ea.

69-18028 69-73 TH350, Modulator mounted on right side ..\$ 25.00 ea.

67-18027 68-72 TH400 .....\$ 25.00 ea.

### STAINLESS STEEL

67-180251 67-69 Powerglide .....\$ 35.00 ea.

67-180261 68-72 TH350, Modulator mounted on left side ..\$ 35.00 ea.

69-180281 69-73 TH350, Modulator mounted on right side ..\$ 35.00 ea.

67-180271 68-72 TH400 .....\$ 35.00 ea.

## TRANSMISSION OIL DIPSTICK



67-181012 63-73 Powerglide .....\$ 29.00 ea.

67-181013 67-78 TH350, 28 5/8" .....\$ 24.00 ea.

67-181014 68-78 TH400, 25 1/2" .....\$ 24.00 ea.



67-181011 TH700R4, 2004R .....\$ 14.00 ea.

## TRANSMISSION OIL DIPSTICK TUBE SEALS



Dipstick tube seal.

67-18106 63-78 PG, TH350, TH400 ...\$ 3.00 ea.

67-181061 TH700R4, 2004R .....\$ 4.00 ea.

## TRANSMISSION OIL DIPSTICK TUBE



67-181031 63-70 Powerglide .....\$ 29.00 ea.



67-18105 68-74 TH400 .....\$ 32.00 ea.

+ The following items require additional shipping and handling.

Fax Order 1-714-771-0407 • Toll Free 1-800-235-2470 • [www.TruckandCarShop.com](http://www.TruckandCarShop.com) • 2014 Catalog



# CHEVROLET NOVA PARTS

Car Shop Inc. 739 North Batavia Orange, California 92868

## TRANSMISSION OIL DIPSTICK & TUBE



Dipstick and tube, black.

- 67-181074 67-78 TH350 .....\$ 49.00 ea.  
 67-181075 68-78 TH400 .....\$ 49.00 ea.



- 67-181076 TH700R4, black .....\$ 35.00 ea.



Dipstick and tube, chrome.

- 67-18107 67-70 Powerglide .....\$ 15.00 ea.  
 67-18108 67-78 TH350 .....\$ 15.00 ea.  
 67-181081 68-78 TH400 .....\$ 15.00 ea.



Braided stainless steel tube type, firewall mount handle.

- 67-181085 Powerglide, 29" .....\$ 38.00 ea.  
 67-181086 TH350/TH400, 30" .....\$ 38.00 ea.  
 67-181087 TH700R4, 25" .....\$ 38.00 ea.  
 67-181088 TH700R4, 30" .....\$ 38.00 ea.

## TRANSMISSION CROSSMEMBERS



With TH350, 4-speed or Powerglide.

- 62-18109 62-67 .....\$ 77.00 ea.



With TH350, 4-speed or Powerglide.

- 62-181091 62-67 .....\$ 119.00 ea.



Small block with Powerglide, TH350 or 4-speed.

- 67-18109 68-72 .....\$ 72.00 ea.

Big block with 4-speed.

- 67-181091 68-72 .....\$ 139.00 ea.



- 67-18110 68-72 TH400 .....\$ 69.00 ea.

## TRANSMISSION MOUNTS



- 67-18112 63-79 All exc, TH400 .....\$ 8.00 ea.  
 67-18113 67-74 TH400 .....\$ 8.00 ea.



- 67-181121 63-79 Polyurethane fits TH350/400  
 700R4, PG, 3 & 4 spd. . . \$ 35.00 ea.

## TRANSMISSION MOUNT BOLT KIT



Includes 4 bolts and 4 lock washers and 2 flat washers.

- 67-18114 63-79 10 pieces .....\$ 6.00 kit

## TRANSMISSION CROSSMEMBER MOUNT KIT



- 62-181141 62-67 4 pieces .....\$ 6.00 kit



- 62-181141 68-74 14 pieces .....\$ 7.00 kit

## BELLHOUSING



New reproduction high performance 11" style 4-speed bellhousing.

- 67-142055 64-74 .....\$ 175.00 ea.  
 67-142056 64-74 Heavy Duty .....\$ 249.00 ea.

## CLUTCH KITS

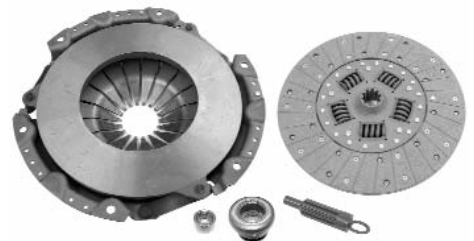

- 67-181221 64-69 283, 327  
 69-79 350  
 10.4", 10 spline  
 raised diaphragm .....\$ 115.00 kit  
 67-181231 62-74 194, 230, 250  
 10", 10 spline  
 flat diaphragm .....\$ 155.00 kit  
 67-181241 64-69 327  
 67-70 350  
 67-70 396, 427  
 11", 10 spline  
 raised diaphragm .....\$ 130.00 kit  
 67-181251 71-74 350  
 11", 26 spline  
 raised diaphragm .....\$ 145.00 kit

# CHEVROLET NOVA PARTS



Car Shop Inc. 739 North Batavia Orange, California 92868

## CLUTCH ALIGNMENT TOOL



- |          |       |                             |             |
|----------|-------|-----------------------------|-------------|
| 67-18204 | 62-74 | 10 Spline, 1 1/8" . . . . . | \$ 5.00 ea. |
| 67-18205 | 71-74 | 26 Spline, 1 1/8" . . . . . | \$ 5.00 ea. |

## THROWOUT BEARING



- |          |       |  |              |
|----------|-------|--|--------------|
| 67-18120 | 62-74 | With flat diaphragm clutch cover . . . . .   | \$ 42.00 ea. |
| 67-18121 | 62-74 | With raised diaphragm clutch cover . . . . . | \$ 29.00 ea. |

## PILOT BEARING



- |          |       |           |              |
|----------|-------|-----------|--------------|
| 67-18203 | 62-74 | . . . . . | \$ 18.00 ea. |
|----------|-------|-----------|--------------|

## TRANSMISSION BOLT KIT



- With stainless steel "ARP" bellhousing to block bolts.  
Includes: ("ARP" six point) Bellhousing to block & rear mount bolts, (Hex head) tail shaft, shift lever, dust cover, speedometer & vacuum module bolts.
- |          |       |           |              |
|----------|-------|-----------|--------------|
| 67-18220 | TH350 | . . . . . | \$ 56.00 kit |
|----------|-------|-----------|--------------|
- Includes: ("ARP" six point) Bellhousing to block, tail shaft & rear mount bolts, (Hex head) side cover, dust cover, speedometer & vacuum module bolts.
- |          |       |           |              |
|----------|-------|-----------|--------------|
| 67-18221 | TH400 | . . . . . | \$ 64.00 kit |
|----------|-------|-----------|--------------|
- Includes: ("ARP" six point) Bellhousing to block, tail shaft, rear mount, shift lever, dust cover, kick down & speedometer bolts.
- |          |       |           |              |
|----------|-------|-----------|--------------|
| 67-18222 | 700R4 | . . . . . | \$ 59.00 kit |
|----------|-------|-----------|--------------|
- Without bellhousing to block bolts.
- |          |       |           |              |
|----------|-------|-----------|--------------|
| 67-18223 | TH350 | . . . . . | \$ 30.00 kit |
| 67-18224 | TH400 | . . . . . | \$ 30.00 kit |
| 67-18225 | 700R4 | . . . . . | \$ 30.00 kit |

## CLUTCH PRESSURE PLATE BOLT KIT



Includes 6 bolts and 6 lock washers, grade 5.  
Original "Double circle" headmark, 7/16-14 x 1 1/4".

- |          |       |           |             |
|----------|-------|-----------|-------------|
| 67-18201 | 62-74 | . . . . . | \$ 8.00 kit |
|----------|-------|-----------|-------------|

## BELLHOUSING BOLT KIT



Includes 6 bolts, grade 5, zinc plated.  
Original headmark, 3/8-16 x 1 1/4".

- |          |       |           |             |
|----------|-------|-----------|-------------|
| 67-18202 | 62-74 | . . . . . | \$ 9.00 kit |
|----------|-------|-----------|-------------|

## TORQUE CONVERTER TO FLEX PLATE BOLT KIT



- |           |       |                       |             |
|-----------|-------|-----------------------|-------------|
| 67-182022 | 62-74 | PG or TH350 . . . . . | \$ 9.00 kit |
| 67-182023 | 62-74 | TH400 . . . . .       | \$ 9.00 kit |

## FLEXPLATE TO CRANKSHAFT BOLT KIT



- |           |       |                        |              |
|-----------|-------|------------------------|--------------|
| 67-182025 | 62-74 | with AT trans. . . . . | \$ 12.00 kit |
|-----------|-------|------------------------|--------------|

## FLYWHEEL TO CRANK BOLT KIT



- |           |       |           |             |
|-----------|-------|-----------|-------------|
| 67-182026 | 62-74 | . . . . . | \$ 8.00 kit |
|-----------|-------|-----------|-------------|

## FLEXPLATE



- |           |       |                          |              |
|-----------|-------|--------------------------|--------------|
| 67-182061 | 64-70 | A/T, 153 tooth . . . . . | \$ 34.00 ea. |
| 67-18206  | 66-74 | A/T, 168 tooth . . . . . | \$ 25.00 ea. |

## FLYWHEEL



- |           |       |   |               |
|-----------|-------|---|---------------|
| 67-182062 | 62-74 | M/T 153 tooth, repro . . .              | \$ 169.00 ea. |
| 67-182063 | 62-74 | M/T 153 tooth, GM . . .                 | \$ 283.00 ea. |
| 67-18207  | 62-74 | M/T 168 tooth, Exc. S/B 400 & 454 . . . | \$ 155.00 ea. |
| 67-18208  | 62-74 | M/T 168 tooth, S/B 400 & B/B 454 . . .  | \$ 155.00 ea. |

## FLYWHEEL COVERS



- Chrome
- |           |                               |              |
|-----------|-------------------------------|--------------|
| 67-18209  | TH350 or TH400 . . . . .      | \$ 20.00 ea. |
| 67-182091 | aluminum powerglide . . . . . | \$ 32.00 ea. |
| 67-182092 | TH700R4 . . . . .             | \$ 35.00 ea. |



- Polished aluminum
- |          |                 |              |
|----------|-----------------|--------------|
| 67-18210 | TH350 . . . . . | \$ 39.00 ea. |
|----------|-----------------|--------------|



- |          |                               |              |
|----------|-------------------------------|--------------|
| 67-18211 | Powerglide, plastic . . . . . | \$ 49.00 ea. |
|----------|-------------------------------|--------------|



- |          |   |              |
|----------|---|--------------|
| 67-18212 | TH350 or TH400, steel black, import . . . . . | \$ 16.00 ea. |
|----------|---|--------------|



- GM replacement, 2 7/16" starter opening, trim for some applications.
- |          |                        |              |
|----------|------------------------|--------------|
| 67-18212 | TH350, steel . . . . . | \$ 47.00 ea. |
|----------|------------------------|--------------|
- GM replacement, 2 3/8" starter opening, trim for some applications.
- |          |                        |              |
|----------|------------------------|--------------|
| 67-18213 | TH400, steel . . . . . | \$ 41.00 ea. |
|----------|------------------------|--------------|

+ The following items require additional shipping and handling.



# CHEVROLET NOVA PARTS

Car Shop Inc. 739 North Batavia Orange, California 92868

## FLYWHEEL COVERS



- 67-18214 62-72 6-cylinder,  
65-67 327  
68-69 327 2-BBL  
69-70 350 2-BBL ..... \$ 24.00 ea.



- Fits 65-68 327, 69-74 350, 68-72 396 & 67-69 427.  
67-18215 67-74 with HD clutch ..... \$ 26.00 ea.

## 700R4 TORQUE CONVERTER LOCK-UP SWITCH KIT



- Externally installed kit allows for automatic operation of the torque converter lock-up (overdrive) without installing the computer. Includes instructions.  
67-18230 fits 700R4 or 200R4 ..... \$ 94.00 kit

## TRUNK SPATTER PAINT



- 67-18401 Black and aqua ..... \$ 14.00 ea.  
74-18402 Gray and white ..... \$ 14.00 ea.  
67-184022 clear top coat ..... \$ 14.00 ea.

## PAINT



- A semi-gloss Black finish for under hood, core support, etc. for that O.E.M. look, great for touch-ups!  
67-18403 Semi-gloss black ..... \$ 8.00 ea.  
67-18404 Chevy engine orange ..... \$ 8.00 ea.



- A low sheen cast finish for the purist wanting the O.E.M. look of natural cast iron factory part.  
67-18405 Cast iron gray 1200° ..... \$ 8.00 ea.



- 67-18407 Shock absorber gray ..... \$ 8.00 ea.  
67-18408 Rally wheel silver ..... \$ 8.00 ea.



- 67-18409 Stainless steel ..... \$ 8.00 ea.  
67-18410 Aluminum silver ..... \$ 8.00 ea.  
67-18411 70-79 Z/28 wheel gray & 69-70 SS wheel insert gray . . . \$ 8.00 ea.

## URETHANE PRIMER



- Urethane & Vinyl Prep Adhesion Promoter**  
Recommended when spraying reproduction dash pads, arm rest pads, inner padded pillar post molding, and all urethane & vinyl products. Primer should always be used when changing colors on urethane products for long lasting results.  
67-18412 12 oz. aerosol ..... \$ 16.00 ea.

- Plastic & Metal Primer**  
67-18412 12 oz. aerosol ..... \$ 17.00 ea.

## INTERIOR PAINT



- PREMIUM QUALITY INTERIOR PAINT**  
New Interior paint formula is UV stable and color fast. Penetrates & molecularly bonds to the surface. Provides 40% more coverage than standard dyes & lacquers. For use on vinyl, leather, ABS plastic, polycarbonate, polypropylene, polyurethane, acrylic, lexan, fiberglass and recycled plastics, 12 oz. aerosol.

- 67-18413 62-74 Black ..... \$ 17.00 ea.  
67-18414 63-69 Red ..... \$ 17.00 ea.  
67-18415 65-67 Light blue  
69-70 Light blue ..... \$ 17.00 ea.  
67-18416 66-67 Bright blue ..... \$ 17.00 ea.  
67-18417 67-70 Gold ..... \$ 17.00 ea.  
67-18418 65-66 Aqua/Turquoise ..... \$ 17.00 ea.  
67-18419 67 Parchment ..... \$ 17.00 ea.  
68-18420 68 Medium blue ..... \$ 17.00 ea.  
68-18421 67-68 Ivy gold ..... \$ 17.00 ea.  
69-18425 71 Dark blue ..... \$ 17.00 ea.  
69-18426 69-70 Dark green  
72 Dark green ..... \$ 17.00 ea.  
69-18427 69 Light green ..... \$ 17.00 ea.  
70-18428 70 Light saddle ..... \$ 17.00 ea.  
70-18429 71 Dark saddle ..... \$ 17.00 ea.

\* The following items require additional shipping and handling.

# CHEVROLET NOVA PARTS



Car Shop Inc. 739 North Batavia Orange, California 92868

## ENGINE COMPARTMENT DECALS



### 6-cylinder Air Cleaner Decals

62-18501 153 Super-Thrift 90 hp .....\$ 4.50 ea.



63-18501 194 Hi-Thrift, 120 hp .....\$ 4.50 ea.



67-18501 250 Turbo-Thrift .....\$ 3.50 ea.  
 67-18502 250 Turbo-Thrift, Rectangle ..\$ 3.50 ea.  
 67-18503 250 Turbo-Thrift 145 hp ....\$ 3.50 ea.  
 67-18504 250 Turbo-Thrift 155 hp .....\$ 3.50 ea.



### Small Block Air Cleaner Decals

67-18505 307 Turbo-Fire 175 hp .....\$ 3.50 ea.  
 67-18506 307 Turbo-Fire 200 hp .....\$ 3.50 ea.



67-18507 327 Turbo-Fire 185 hp .....\$ 3.50 ea.  
 67-18508 327 Turbo-Fire 200 hp .....\$ 3.50 ea.  
 67-18509 327 Turbo-Fire 210 hp .....\$ 3.50 ea.  
 67-18510 327 Turbo-Fire 230 hp .....\$ 3.50 ea.  
 67-18511 327 Turbo-Fire 235 hp .....\$ 3.50 ea.  
 67-18512 327 Turbo-Fire 250 hp .....\$ 3.50 ea.



## ENGINE COMPARTMENT DECALS



### Small Block Air Cleaner Decals

67-18513 327 Turbo-Fire 275 hp .....\$ 3.50 ea.  
 67-18514 327 Turbo-Fire 300 hp .....\$ 3.50 ea.  
 67-18515 327 Turbo-Fire 325 hp .....\$ 3.50 ea.  
 67-18516 327 Turbo-Fire 350 hp .....\$ 3.50 ea.  
 67-18517 327 Turbo-Fire 365 hp .....\$ 3.50 ea.



67-18518 350 Turbo-Fire .....\$ 3.50 ea.  
 67-18519 350 Turbo-Fire 225 hp .....\$ 3.50 ea.  
 67-18520 350 Turbo-Fire 240 hp .....\$ 3.50 ea.  
 67-18521 350 Turbo-Fire 245 hp .....\$ 3.50 ea.  
 67-18522 350 Turbo-Fire 250 hp .....\$ 3.50 ea.  
 67-18523 350 Turbo-Fire 255 hp .....\$ 3.50 ea.  
 67-18524 350 Turbo-Fire 270 hp .....\$ 3.50 ea.  
 67-18525 350 Turbo-Fire 285 hp .....\$ 3.50 ea.  
 67-18526 350 Turbo-Fire 295 hp .....\$ 3.50 ea.  
 67-18527 350 Turbo-Fire 300 hp .....\$ 3.50 ea.  
 67-18528 350 Turbo-Fire 325 hp .....\$ 3.50 ea.  
 67-18529 350 Turbo-Fire 330 hp .....\$ 3.50 ea.  
 67-18530 350 Turbo-Fire 350 hp .....\$ 3.50 ea.  
 67-18531 350 Turbo-Fire 360 hp .....\$ 3.50 ea.  
 67-18532 350 Turbo-Fire 370 hp .....\$ 3.50 ea.



67-18533 400 Turbo-Fire .....\$ 3.50 ea.  
 67-18534 400 Turbo-Fire 255 hp .....\$ 3.50 ea.  
 67-18535 400 Turbo-Fire 265 hp .....\$ 3.50 ea.  
 67-18536 400 Turbo-Fire 300 hp .....\$ 3.50 ea.



### Big Block Air Cleaner Decals

67-18537 396 Cross Flags .....\$ 3.50 ea.  
 67-18538 400 Cross Flags .....\$ 3.50 ea.  
 67-18539 402 Cross Flags .....\$ 3.50 ea.  
 67-18540 427 Cross Flags .....\$ 3.50 ea.  
 67-18541 454 Cross Flags .....\$ 3.50 ea.

## ENGINE COMPARTMENT DECALS



### Big Block Air Cleaner Decals

67-18542 Turbo-Jet 300 hp .....\$ 3.50 ea.  
 67-18543 Turbo-Jet 325 hp .....\$ 3.50 ea.  
 67-18544 Turbo-Jet 350 hp .....\$ 3.50 ea.  
 67-18545 Turbo-Jet 375 hp .....\$ 3.50 ea.  
 67-18546 Turbo-Jet 385 hp .....\$ 3.50 ea.  
 67-18547 Turbo-Jet 390 hp .....\$ 3.50 ea.  
 67-18548 Turbo-Jet 400 hp .....\$ 3.50 ea.  
 67-18549 Turbo-Jet 425 hp .....\$ 3.50 ea.  
 67-18550 Turbo-Jet 450 hp .....\$ 3.50 ea.  
 67-18551 Turbo-Jet 460 hp .....\$ 3.50 ea.



### Big Block Air Cleaner Decals

67-18552 Turbo-Jet 396/300 hp .....\$ 3.50 ea.  
 67-18553 Turbo-Jet 400/300 hp .....\$ 3.50 ea.  
 67-18554 Turbo-Jet 454/365 hp .....\$ 3.50 ea.  
 67-18555 Turbo-Jet 454/425 hp .....\$ 3.50 ea.



### Tonawanda Valve Cover Decal

Built by Chevrolet Tonawanda The Number 1 Team.

67-18556 chrome .....\$ 3.50 ea.



### 6-cylinder Valve Cover Decals

64-18557 153 Super-Thrift .....\$ 4.50 ea.



62-18557 194 Hi-Thrift .....\$ 4.50 ea.



62-185571 194 Hi-Thrift, 120 hp .....\$ 4.50 ea.

\* The following items require additional shipping and handling.

Fax Order 1-714-771-0407 • Toll Free 1-800-235-2470 • www.TruckandCarShop.com • 2014 Catalog



# CHEVROLET NOVA PARTS

Car Shop Inc. 739 North Batavia Orange, California 92868

## ENGINE COMPARTMENT DECALS



|          |                         |             |
|----------|-------------------------|-------------|
| 58-12505 | 230 Turbo-Thrift 125 hp | \$ 3.50 ea. |
| 58-12506 | 230 Turbo-Thrift 140 hp | \$ 3.50 ea. |
| 58-12507 | 230 Turbo-Thrift 150 hp | \$ 3.50 ea. |
| 58-12508 | 230 Turbo-Thrift 155 hp | \$ 3.50 ea. |
| 58-12509 | 235 High-Thrift         | \$ 3.50 ea. |



|          |                                       |             |
|----------|---------------------------------------|-------------|
| 67-18557 | 250 Turbo-Thrift, silver & red        | \$ 3.50 ea. |
| 67-18558 | 250 Turbo-Thrift                      | \$ 3.50 ea. |
| 67-18559 | 250 Turbo-Thrift 135 hp               | \$ 3.50 ea. |
| 67-18560 | 250 Turbo-Thrift 150 hp               | \$ 3.50 ea. |
| 67-18561 | 250 Turbo-Thrift 155 hp, silver & red | \$ 3.50 ea. |



**Small Block Valve Cover Decals**

|          |                        |             |
|----------|------------------------|-------------|
| 67-18601 | 283 Turbo-Fire         | \$ 3.50 ea. |
| 67-18602 | 283 Turbo-Fire, 195 hp | \$ 3.50 ea. |
| 67-18603 | 283 Turbo-Fire, 220 hp | \$ 3.50 ea. |



|          |                          |             |
|----------|--------------------------|-------------|
| 67-18604 | 327 Turbo-Fire, paper    | \$ 3.50 ea. |
| 67-18605 | 327 Turbo-Fire, aluminum | \$ 5.00 ea. |



|          |                        |             |
|----------|------------------------|-------------|
| 67-18606 | 327 Turbo-Fire, 275 hp | \$ 3.50 ea. |
| 67-18607 | 327 Turbo-Fire, 300 hp | \$ 3.50 ea. |
| 67-18608 | 327 Turbo-Fire, 350 hp | \$ 3.50 ea. |

## DECALS, LABELS & LITERATURE



**Big Block Valve Cover Decals**

|          |                        |             |
|----------|------------------------|-------------|
| 67-18609 | 396 Turbo-Fire, 325 hp | \$ 3.50 ea. |
|----------|------------------------|-------------|



**Horsepower Valve Cover Decals**

|          |                |             |
|----------|----------------|-------------|
| 67-18610 | 170 Horsepower | \$ 3.50 ea. |
| 67-18611 | 185 Horsepower | \$ 3.50 ea. |
| 67-18612 | 195 Horsepower | \$ 3.50 ea. |
| 67-18613 | 210 Horsepower | \$ 3.50 ea. |
| 67-18614 | 220 Horsepower | \$ 3.50 ea. |
| 67-18615 | 230 Horsepower | \$ 3.50 ea. |
| 67-18616 | 245 Horsepower | \$ 3.50 ea. |
| 67-18617 | 260 Horsepower | \$ 3.50 ea. |
| 67-18618 | 270 Horsepower | \$ 3.50 ea. |
| 67-18619 | 275 Horsepower | \$ 3.50 ea. |
| 67-18620 | 280 Horsepower | \$ 3.50 ea. |
| 67-18621 | 290 Horsepower | \$ 3.50 ea. |



**Horsepower Valve Cover Decals**

|          |                |             |
|----------|----------------|-------------|
| 67-18622 | 300 Horsepower | \$ 3.50 ea. |
| 67-18623 | 305 Horsepower | \$ 3.50 ea. |
| 67-18624 | 315 Horsepower | \$ 3.50 ea. |
| 67-18625 | 320 Horsepower | \$ 3.50 ea. |
| 67-18626 | 335 Horsepower | \$ 3.50 ea. |
| 67-18627 | 340 Horsepower | \$ 3.50 ea. |
| 67-18628 | 345 Horsepower | \$ 3.50 ea. |
| 67-18629 | 350 Horsepower | \$ 3.50 ea. |
| 67-18630 | 360 Horsepower | \$ 3.50 ea. |
| 67-18631 | 360 Horsepower | \$ 3.50 ea. |
| 67-18632 | 375 Horsepower | \$ 3.50 ea. |
| 67-18633 | 380 Horsepower | \$ 3.50 ea. |
| 67-18634 | 400 Horsepower | \$ 3.50 ea. |
| 67-18635 | 409 Horsepower | \$ 3.50 ea. |
| 67-18636 | 425 Horsepower | \$ 3.50 ea. |

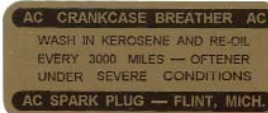

**Crankcase Breather Decal**

|          |                                       |             |
|----------|---------------------------------------|-------------|
| 59-12528 | 62-63 Oil filler decal (black & gold) | \$ 3.50 ea. |
|----------|---------------------------------------|-------------|

## DECALS, LABELS & LITERATURE



|          |   |             |
|----------|---|-------------|
| 67-18637 | 64-67 Crankcase breather decal (red, white, blue) | \$ 3.50 ea. |
|----------|---|-------------|



**Battery Warning Decal**

|          |   |             |
|----------|---|-------------|
| 67-18638 | Warning to connect positive to positive | \$ 3.50 ea. |
|----------|---|-------------|

## CAUTION

**THIS VEHICLE EQUIPPED WITH LIMITED SLIP DIFFERENTIAL. REAR WHEEL MAY DRIVE IF IN CONTACT WITH GROUND EVEN THOUGH OPPOSITE WHEEL IS RAISED. DO NOT RUN ENGINE WITH VEHICLE ON JACK UNLESS TRANSMISSION IS IN NEUTRAL OR PARK. SEE OWNER'S MANUAL.**

PRINTED IN U.S.A. 7-22-58 PART NO. 3745925

**Positraction Decals**

|          |                    |             |
|----------|--------------------|-------------|
| 67-18639 | 58-71 Positraction | \$ 3.50 ea. |
| 72-18640 | 72 Positraction    | \$ 3.50 ea. |



**Jacking Instruction Decals**

|          |                            |             |
|----------|----------------------------|-------------|
| 62-18641 | 62-65 hardtop, 3791461     | \$ 3.50 ea. |
| 62-18642 | 62-63 convertible, 3791463 | \$ 3.50 ea. |
| 64-18643 | 64-65 3858854              | \$ 3.50 ea. |
| 66-18644 | 66 3887642                 | \$ 3.50 ea. |
| 67-18645 | 67 3899820                 | \$ 3.50 ea. |
| 68-18647 | 68 3937549                 | \$ 3.50 ea. |
| 68-18648 | 68-70 exc. SS, 3962723     | \$ 3.50 ea. |
| 69-18653 | 69 SS, 3949679             | \$ 3.50 ea. |
| 69-18654 | 69-70 SS, 3949659          | \$ 3.50 ea. |
| 69-18655 | 69-70 exc. SS, 3949717     | \$ 3.50 ea. |
| 71-18656 | 71 3986542                 | \$ 3.50 ea. |



**Jack Base Decal**

|          |       |             |
|----------|-------|-------------|
| 62-12678 | 62-64 | \$ 3.50 ea. |
|----------|-------|-------------|



# CHEVROLET NOVA PARTS



Car Shop Inc. 739 North Batavia Orange, California 92868

## DECALS, LABELS & LITERATURE

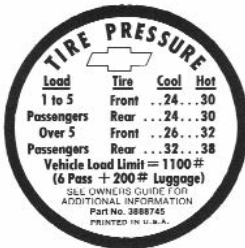

### Tire Pressure Decals

|           |       |                        |             |
|-----------|-------|------------------------|-------------|
| 62-18707  | 62-63 | 3777060                | \$ 4.50 ea. |
| 64-18707  | 64-65 | 3870199                | \$ 3.50 ea. |
| 62-18709  | 62-65 | wagon, 3771060         | \$ 4.50 ea. |
| 66-18707  | 66    | 3888745                | \$ 3.50 ea. |
| 67-18708  | 66    | SS, 3888749            | \$ 3.50 ea. |
| 66-18709  | 66    | wagon, 3888748         | \$ 4.50 ea. |
| 67-18710  | 67    | 6-cyl, 3923595 (K)     | \$ 3.50 ea. |
| 67-18709  | 67    | wagon, 3912541 (M)     | \$ 3.50 ea. |
| 67-18708  | 67    | SS, 3912543            | \$ 3.50 ea. |
|           |       | before 2-20-1967       | \$ 3.50 ea. |
| 67-187081 | 67    | with 283, 3923596 (L)  | \$ 3.50 ea. |
|           |       | before 3-28-1967       | \$ 3.50 ea. |
| 67-187082 | 67    | with 283, 3925856      | \$ 3.50 ea. |
|           |       | after 3-28-1967        | \$ 3.50 ea. |
| 67-187083 | 67    | with 327, 3925857      | \$ 3.50 ea. |
| 67-187084 | 67    | SS-350, 3917576 (R)    | \$ 4.50 ea. |
|           |       | before 3-28-1967       | \$ 4.50 ea. |
| 67-187085 | 67    | SS-350, 3952882        | \$ 3.50 ea. |
|           |       | after 3-28-1967        | \$ 3.50 ea. |
| 68-18707  | 68    | 735 x 14, 3934880      | \$ 4.50 ea. |
| 68-18708  | 68    | E70 x 14, 3934877 (AC) | \$ 4.50 ea. |



|          |       |                                    |             |
|----------|-------|------------------------------------|-------------|
| 69-18709 | 69    | exc SS, E78 x 14, 3961710 (DP)     | \$ 4.50 ea. |
| 69-18710 | 69    | SS, F78 x 14, 3960699 (DW)         | \$ 4.50 ea. |
| 69-18711 | 69    | SS, E70 x 14, 3961714 (DT)         | \$ 4.50 ea. |
| 70-18712 | 70    | E78 x 14, 3983004 (BB)             | \$ 4.50 ea. |
| 71-18713 | 71-72 | E70 x 14 or E78 x 14, 3990523 (GM) | \$ 4.50 ea. |
| 72-18714 | 72    | F60 x 15, 6271200 (AB)             | \$ 4.50 ea. |
| 73-18715 | 73-74 | E70 x 14 or E78 x 14, 334408 (ZN)  | \$ 4.50 ea. |

## DECALS, LABELS & LITERATURE



### Air Conditioning Firewall Box Labels

|          |    |            |             |
|----------|----|------------|-------------|
| 65-12706 | 65 | EBA-70-65B | \$ 3.50 ea. |
| 66-12707 | 66 | EBA-70-66B | \$ 3.50 ea. |
| 67-18718 | 67 | EBA-70-67B | \$ 3.50 ea. |
| 68-18719 | 68 | EBA-70-68B | \$ 3.50 ea. |
| 69-18720 | 69 | EBA-70-69B | \$ 3.50 ea. |
| 70-18721 | 70 | EBA-70-70B | \$ 3.50 ea. |
| 71-18722 | 71 | EBA-70-71B | \$ 3.50 ea. |
| 72-18723 | 72 | EBA-70-72B | \$ 3.50 ea. |



### Air Conditioning Compressor Labels

|          |       |             |             |
|----------|-------|-------------|-------------|
| 63-12714 | 63-65 |             | \$ 3.50 ea. |
| 66-12715 | 66    |             | \$ 3.50 ea. |
| 67-18724 | 67-68 | Green/black | \$ 3.50 ea. |
| 68-18725 | 68    | Red/black   | \$ 3.50 ea. |
| 69-18726 | 69    | Red/black   | \$ 3.50 ea. |
| 69-18727 | 69-71 | Green/black | \$ 3.50 ea. |
| 70-18728 | 70    | Red/black   | \$ 3.50 ea. |
| 71-18729 | 71    | Red/black   | \$ 3.50 ea. |
| 72-18730 | 72    | Red/black   | \$ 3.50 ea. |
| 72-18731 | 72-73 | Green/black | \$ 3.50 ea. |



### Air Conditioning Window Labels

|          |       |  |             |
|----------|-------|--|-------------|
| 62-12702 | 62-65 |  | \$ 3.50 ea. |
|----------|-------|--|-------------|



|          |       |  |             |
|----------|-------|--|-------------|
| 67-18732 | 66-67 |  | \$ 3.50 ea. |
|----------|-------|--|-------------|

|          |       |                   |             |
|----------|-------|-------------------|-------------|
| 67-18733 | 68-72 | with "Comfortron" | \$ 3.50 ea. |
|----------|-------|-------------------|-------------|

## DECALS, LABELS & LITERATURE



### Service Record Sticker

|          |       |                           |             |
|----------|-------|---------------------------|-------------|
| 67-18734 | 62-74 | Door jamb service sticker |             |
|          |       | Black on silver           | \$ 3.50 ea. |

COOLING SYSTEM WAS PROTECTED TO -20°F. AT TIME OF DELIVERY FROM PLANT. USE PERMANENT TYPE ETHYLENE GLYCOL BASE, ANTIFREEZE ONLY. COOLING SYSTEM IS EQUIPPED WITH 180° THERMOSTAT AND IS PRESSURIZED. ALWAYS BE SURE RADIATOR CAP IS INSTALLED TIGHTLY OTHERWISE DAMAGE TO ENGINE MAY RESULT FROM OVERHEATING. SEE OWNERS GUIDE FOR SERVICE RECOMMENDATIONS.

### Engine Cooling System Decal

|          |       |               |             |
|----------|-------|---------------|-------------|
| 64-13802 | 64    | Caution Boxed | \$ 3.50 ea. |
| 64-13803 | 64-65 | Caution       | \$ 3.50 ea. |

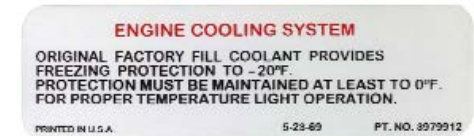

|          |       |  |             |
|----------|-------|--|-------------|
| 70-18735 | 70-72 |  | \$ 3.50 ea. |
|----------|-------|--|-------------|



### Caution Fan Decal

|          |  |                      |             |
|----------|--|----------------------|-------------|
| 67-18736 |  | "Keep Fingers Clear" | \$ 3.50 ea. |
|----------|--|----------------------|-------------|



### Winterized Label

|          |  |             |             |
|----------|--|-------------|-------------|
| 67-18824 |  | paper label | \$ 3.50 ea. |
|----------|--|-------------|-------------|

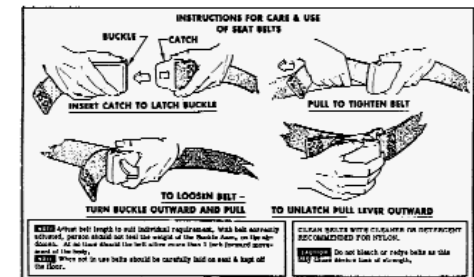

### Seat Belt Instruction Card

|          |  |                |             |
|----------|--|----------------|-------------|
| 67-18738 |  | Seat belt card | \$ 4.00 ea. |
|----------|--|----------------|-------------|

+ The following items require additional shipping and handling.



# CHEVROLET NOVA PARTS



Car Shop Inc. 739 North Batavia Orange, California 92868

## DECALS, LABELS & LITERATURE



### Oil Filter Decal

67-18832 64-67 V8 "Type PM-16" ..... \$ 3.50 ea.



### Generator Warning Tag

58-12533 62 ..... \$ 3.50 ea.



### Alternator Decal

67-18860 63-71 Delcotron ..... \$ 3.50 ea.

**TO SET AND USE SPEED AND CRUISE CONTROL:**  
SET CRUISE CONTROL SWITCH TO ON POSITION. OPERATE VEHICLE AT DESIRED SPEED. TURN CONTROL WHEEL UNTIL BACK PRESSURE IS FELT ON ACCELERATOR PEDAL. BACK PRESSURE CAN BE USED AS SPEED REMINDER. CRUISE CONTROL IS INOPERATIVE WHEN SWITCH IS IN OFF POSITION.

**TO USE AUTOMATIC CONTROL:**  
ENGAGE BY MOVING BUTTON TO LOCK WHILE HOLDING ACCELERATOR AGAINST BACK PRESSURE.

**TO DISENGAGE:**  
DEPRESS BRAKE OR CLUTCH PEDAL, MOVE BUTTON TO OFF, OR TURN OFF IGNITION.

**TO OPERATE ABOVE SET SPEED:**  
INCREASE FOOT PRESSURE ON ACCELERATOR PEDAL TO OVERCOME BACK PRESSURE.

ATTACH ABOVE INSTRUCTIONS TO REAR INNER SURFACE OF GLOVE COMPARTMENT - 3847945

### Cruise Control Decal

62-12674 62-66 ..... \$ 3.50 ea.  
67-18865 67-69 ..... \$ 3.50 ea.



### Steering Box Inspection Decal

69-18870 69 yellow oval ..... \$ 3.50 ea.



### Tire Inflator Decal

67-18875 67-72 7.35 x 14 ..... \$ 3.50 ea.  
70-18875 70-72 7.75 x 14 ..... \$ 3.50 ea.

## DECALS, LABELS & LITERATURE

THIS ENGINE IS EQUIPPED TO REDUCE EXHAUST EMISSIONS. THE FOLLOWING ADJUSTMENTS ARE NECESSARY TO MAINTAIN THE EFFECTIVENESS OF THE SYSTEM:

- Set ignition correctly by using 180° cam and adjust speed screw to obtain 900 RPM on tachometer.
- Set怠速 (idle) at 4" rise with vacuum advance bar protruding.
- Adjust mixture screw to obtain 1.25 ppm (lean mix).
- Adjust mixture screw to 1.5 ppm.
- Repeat steps 2 and 3 until 1.25 ppm (lean mix) is obtained.
- See Service Manual for Additional Service Instructions.

### 1968 Tune-up Labels

68-18901 6-cylinder A.T. (A) ..... \$ 3.50 ea.  
68-18902 327/250 A.T.  
327/275 A.T.  
396/325 A.T.  
396/325 A.T. (B) ..... \$ 3.50 ea.  
68-18903 396/325 M.T. (F) ..... \$ 3.50 ea.  
68-18904 6-cylinder A.T. (J) ..... \$ 3.50 ea.  
68-18905 307/200 A.T. (L) ..... \$ 3.50 ea.  
68-18906 307/200 M.T. (Q) ..... \$ 3.50 ea.  
68-18907 327/250 M.T. (T) ..... \$ 3.50 ea.  
68-18908 327/275 M.T. (S) ..... \$ 3.50 ea.  
68-18909 327/325 M.T. (U) ..... \$ 3.50 ea.  
68-18910 396/375 M.T. (M) ..... \$ 3.50 ea.

THIS ENGINE IS EQUIPPED TO REDUCE EXHAUST EMISSIONS. THE FOLLOWING ADJUSTMENTS ARE NECESSARY TO MAINTAIN THE EFFECTIVENESS OF THE SYSTEM:

- Set mixture screw for 1.25 ppm (lean mix) and adjust speed screw to obtain 900 RPM on tachometer.
- Set ignition timing to specification. (This advance element fits — this only only.)
- Adjust idle mixture screw to obtain 1.25 ppm (lean mix) when tank cut the tank.
- If necessary, readjust speed screw to specification.

### 1969 Tune-up Labels

69-18911 140 H.P. AT/MT  
155 H.P. AT/MT (CD) ..... \$ 3.50 ea.  
69-18912 307/200 AT/MT  
327/210, 235, 250 AT/MT  
(CE) ..... \$ 3.50 ea.  
69-18913 302/290 MT  
350/255, 300 MT/AT  
350/350, 370 MT. (CF) ..... \$ 3.50 ea.  
69-18914 396/325, 350 AT/MT (CG) ..... \$ 3.50 ea.  
69-18915 396/375 AT/MT (43) ..... \$ 3.50 ea.  
69-18916 427/425 AT/MT (CJ) ..... \$ 3.50 ea.  
69-18917 427/425 AT/MT (CN) ..... \$ 3.50 ea.  
69-18918 307 AT/MT  
350/240 AT/MT  
396 AT/MT (DC) ..... \$ 3.50 ea.

VEHICLE EMISSION CONTROL INFORMATION - MANUFACTURED BY GENERAL MOTORS CORP.

1. ENGINE MODEL WITH LABELS AS SHOWN, EXCEPT FOR LABELS SHOWN IN OTHER COUNTRIES, IS SUBJECT TO FEDERAL EMISSIONS REGULATIONS. OTHER COUNTRIES MAY HAVE DIFFERENT REGULATIONS. CHECK WITH LOCAL REGULATORY AGENCIES FOR APPLICABLE REGULATIONS.

2. EMISSIONS REGULATIONS MAY VARY BY STATE AND COUNTRY. CHECK WITH LOCAL REGULATORY AGENCIES FOR APPLICABLE REGULATIONS.

3. EMISSIONS REGULATIONS MAY VARY BY STATE AND COUNTRY. CHECK WITH LOCAL REGULATORY AGENCIES FOR APPLICABLE REGULATIONS.

### 1970 Tune-up Labels

70-18919 307/200 AT/MT (AO) ..... \$ 3.50 ea.  
70-18920 350/250 AT/MT (AQ) ..... \$ 3.50 ea.  
70-18921 350/350 MT (AX) ..... \$ 3.50 ea.  
70-18922 400/265 AT/MT (AP) ..... \$ 3.50 ea.  
70-18923 402/350 MT (AR) ..... \$ 3.50 ea.  
70-18924 402/350 AT (AT) ..... \$ 3.50 ea.  
70-18925 402/375 AT/MT (AY) ..... \$ 3.50 ea.  
70-18926 454/350, 360, 390  
AT/MT (AW) ..... \$ 3.50 ea.  
70-18927 454/450 AT/MT (AZ) ..... \$ 3.50 ea.

## DECALS, LABELS & LITERATURE

TO REDUCE FUEL VAPOR LOSSES, THIS VEHICLE IS EQUIPPED WITH GENERAL MOTORS EVAPORATION CONTROL SYSTEM.

- After Tuning Procedure—Perform "TUNE" "TUNE" Tune Valve Vapor Control.
- After Tuning Procedure—Perform "TUNE" "TUNE" Tune Valve Vapor Control.

### 1970 Tune-up Labels

70-18928 307 & 350 Calif. E71  
Evap. Control (CA) ..... \$ 3.50 ea.

TO REDUCE FUEL VAPOR LOSSES, THIS VEHICLE IS EQUIPPED WITH GENERAL MOTORS EVAPORATION CONTROL SYSTEM.

- After Tuning Procedure—Perform "TUNE" "TUNE" Tune Valve Vapor Control.
- After Tuning Procedure—Perform "TUNE" "TUNE" Tune Valve Vapor Control.

70-18929 396 & 454 Calif. E71  
Evap. Control (CB) ..... \$ 3.50 ea.

70-18930 360, 370, 460 & 465 hp AT/MT  
(CL 3989299) ..... \$ 3.50 ea.

70-18931 350/300 AT/MT  
(CL 3982955) ..... \$ 3.50 ea.

70-18932 350/360 & 370 MT (CT) ..... \$ 3.50 ea.

70-18933 454/460 AT/MT (CW) ..... \$ 3.50 ea.

70-18934 350/255 AT/MT (CY) ..... \$ 3.50 ea.

70-18935 200 & 265 hp AT/MT (DM) ..... \$ 3.50 ea.

70-18936 350/250 AT/MT (DN) ..... \$ 3.50 ea.

70-18937 350, 360 & 390 hp  
AT/MT (DP) ..... \$ 3.50 ea.

70-18938 396/350 AT/MT (DQ) ..... \$ 3.50 ea.

70-18939 454/435, 360 & 390 hp  
AT/MT (DQ) ..... \$ 3.50 ea.

70-18940 375 & 450 hp MT/AT (DT) ..... \$ 3.50 ea.

VEHICLE EMISSION CONTROL INFORMATION - GENERAL MOTORS CORPORATION

1. ENGINE MODEL WITH LABELS AS SHOWN, EXCEPT FOR LABELS SHOWN IN OTHER COUNTRIES, IS SUBJECT TO FEDERAL EMISSIONS REGULATIONS. OTHER COUNTRIES MAY HAVE DIFFERENT REGULATIONS. CHECK WITH LOCAL REGULATORY AGENCIES FOR APPLICABLE REGULATIONS.

2. EMISSIONS REGULATIONS MAY VARY BY STATE AND COUNTRY. CHECK WITH LOCAL REGULATORY AGENCIES FOR APPLICABLE REGULATIONS.

3. EMISSIONS REGULATIONS MAY VARY BY STATE AND COUNTRY. CHECK WITH LOCAL REGULATORY AGENCIES FOR APPLICABLE REGULATIONS.

### 1971 Tune-up Labels

71-18941 250-1 AT/MT  
US and Canada (AN) ..... \$ 6.00 ea.

71-18942 307-2 AT/MT  
US and Canada (AO) ..... \$ 6.00 ea.

71-18943 350-2 AT/MT  
US and Canada (AP) ..... \$ 6.00 ea.

71-18944 350-4 270 hp AT/MT  
US and Canada (AQ) ..... \$ 6.00 ea.

71-18945 350/270 hp (AR) ..... \$ 6.00 ea.

71-18946 LT-1 350-4 330 hp  
AT/MT  
US and Canada (AX) ..... \$ 6.00 ea.

71-18947 402-4 300 hp AT/MT  
US and Canada (AT) ..... \$ 6.00 ea.

71-18948 454-4 365 hp AT/MT  
US and Canada (AU) ..... \$ 6.00 ea.

71-18949 454-4 425 hp AT/MT  
US and Canada (AZ) ..... \$ 6.00 ea.

† The following items require additional shipping and handling.

Fax Order 1-714-771-0407 • Toll Free 1-800-235-2470 • www.TruckandCarShop.com • 2014 Catalog



# CHEVROLET NOVA PARTS

Car Shop Inc. 739 North Batavia Orange, California 92868

## DECALS, LABELS & LITERATURE

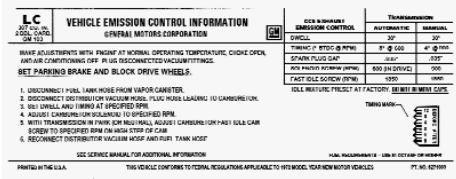

### 1972 Tune-up Labels

|          |                                      |         |          |
|----------|--------------------------------------|---------|----------|
| 72-18950 | 250-1 AT/MT US (LA)                  | .....\$ | 6.00 ea. |
| 72-18951 | 307-2 AT/MT US (LC)                  | .....\$ | 6.00 ea. |
| 72-18952 | 350-2 AT/MT US (LG)                  | .....\$ | 6.00 ea. |
| 72-18953 | 350-4 AT/MT US (LJ)                  | .....\$ | 6.00 ea. |
| 72-18954 | 350-4 AT/MT US (LL)                  | .....\$ | 6.00 ea. |
| 72-18955 | LT-1 350-4 hp MT<br>US & Canada (LP) | .....\$ | 6.00 ea. |
| 72-18956 | 402 AT/MT US (LT)                    | .....\$ | 6.00 ea. |
| 72-18957 | 454 AT/MT US (LX)                    | .....\$ | 6.00 ea. |



### Owners Service Policy

|          |       |                      |      |          |
|----------|-------|----------------------|------|----------|
| 67-18958 | 62-74 | Owner service policy | ..\$ | 3.50 ea. |
|----------|-------|----------------------|------|----------|



### Window Stickers

|          |       |         |          |
|----------|-------|---------|----------|
| 58-11820 | 62-65 | .....\$ | 3.50 ea. |
| 67-18959 | 66-68 | .....\$ | 3.50 ea. |
| 70-18961 | 69-72 | .....\$ | 3.50 ea. |



### Dealer Window Sticker

|          |       |  |         |          |
|----------|-------|--|---------|----------|
| 67-19001 | 62-68 | Dealer window sticker<br>for dealer<br>installed options | .....\$ | 3.50 ea. |
|----------|-------|--|---------|----------|

## DECALS, LABELS & LITERATURE



### Maintenance Schedule Folder

|          |       |         |          |
|----------|-------|---------|----------|
| 67-19002 | 62-72 | .....\$ | 6.00 ea. |
|----------|-------|---------|----------|



### Warranty Sheet

|          |       |                        |      |          |
|----------|-------|------------------------|------|----------|
| 67-19003 | 62-72 | Factory warranty sheet | ..\$ | 3.50 ea. |
|----------|-------|------------------------|------|----------|

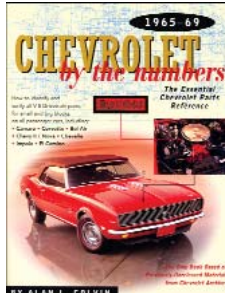

### Chevrolet By the Numbers

This is the only authoritative reference for identifying and verifying, by casting number, the correct Chevrolet V8 engine and drivetrain parts for your exact model.

|          |       |           |         |           |
|----------|-------|-----------|---------|-----------|
| 60-12103 | 60-64 | 280 pages | .....\$ | 34.00 ea. |
| 67-19004 | 65-69 | 335 pages | .....\$ | 34.00 ea. |

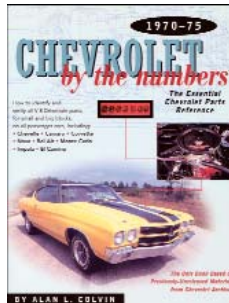

|          |       |           |         |           |
|----------|-------|-----------|---------|-----------|
| 70-19005 | 70-75 | 292 pages | .....\$ | 34.00 ea. |
|----------|-------|-----------|---------|-----------|

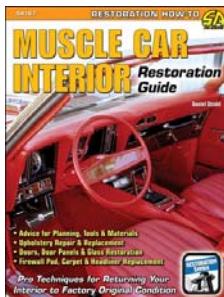

### Muscle Car Interior Restoration Guide

Muscle Car Interior Restoration Guide provides expert insight into the procedures for professionally completing a muscle car restoration.

|          |           |         |           |
|----------|-----------|---------|-----------|
| 67-19015 | 160 pages | .....\$ | 29.00 ea. |
|----------|-----------|---------|-----------|

## BOOKS & LITERATURE

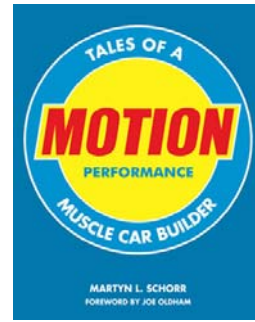

### Motion Performance

By 1967, Rosen's Motion Performance was the place to go if you wanted a true muscle car—and, if you ordered a Baldwin-Motion Chevrolet, a muscle car with a full factory warranty. Motion Performance tells the inside story of how it all happened. Illustrated with period pictures and modern color photos, the book takes readers along as Cobras, Chevrolets, Oldsmobiles, roll into the shop to get torn down and rebuilt into cars unbeatable on the streets and drag strips.

|          |           |         |           |
|----------|-----------|---------|-----------|
| 67-19016 | 176 pages | .....\$ | 34.00 ea. |
|----------|-----------|---------|-----------|

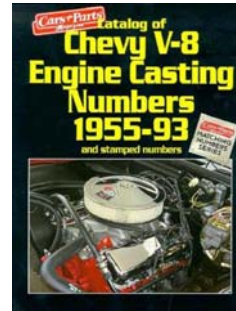

### Catalog of V8 Engine Casting Numbers 1955-1993

|          |           |         |           |
|----------|-----------|---------|-----------|
| 67-19012 | 211 pages | .....\$ | 24.00 ea. |
|----------|-----------|---------|-----------|

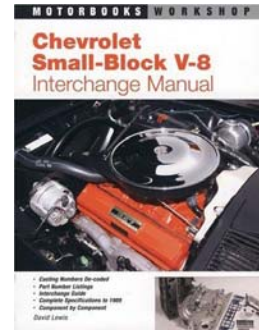

### Chevrolet Small Block V8 Interchange Manual

|          |             |         |           |
|----------|-------------|---------|-----------|
| 67-19101 | 1st Edition | .....\$ | 19.00 ea. |
|----------|-------------|---------|-----------|

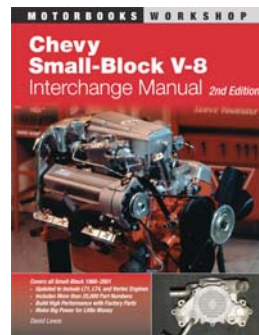

### Chevrolet Small Block V8 Interchange Manual

|          |   |        |           |
|----------|---|--------|-----------|
| 68-19101 | Covers 1968-2001, updated to include LT1, LT4 and Vortec engines.<br>2nd Edition, 175 pages | ....\$ | 24.00 ea. |
|----------|---|--------|-----------|

+ The following items require additional shipping and handling.

# CHEVROLET NOVA PARTS



Car Shop Inc. 739 North Batavia Orange, California 92868

## BOOKS & LITERATURE

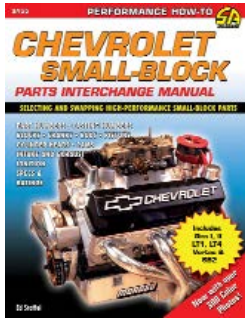

Includes Gen I, II, LT1, LT4, Vortec & SB2.

### Chevrolet Small-Block Parts Interchange Manual

67-191031 ..... \$ 24.00 ea.

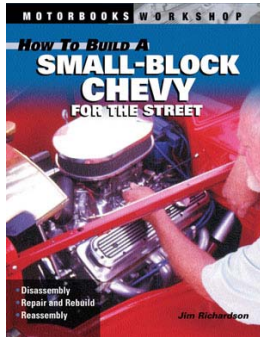

### How To Build A Small-Block Chevy

Excellent book for the first time engine builder or an old pro. Covers engine removal, inspection and assembly. 350 illustrations.

67-191041 192 pages ..... \$ 25.00 ea.

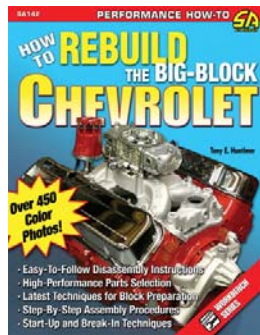

### How To Rebuild The Big Block Chevrolet

Subjects covered include the history of the big-block Chevy, preparation and tool requirements, engine removal and teardown, first inspection, parts, machine work and clean-up, final engine assembly, and start-up.

67-191051 160 pages ..... \$ 24.00 ea.

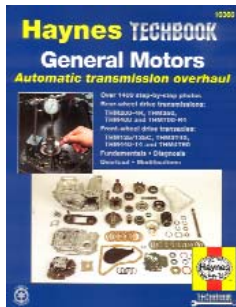

### GM Automatic transmission overhaul techbook

Fundamentals, diagnosis, overhaul & modifications, over 1400 step by step photos. TH350, TH400, TH200-4R & TH700-R4.

67-191071 GM transmission book ..... \$ 25.00 ea.

## BOOKS & LITERATURE

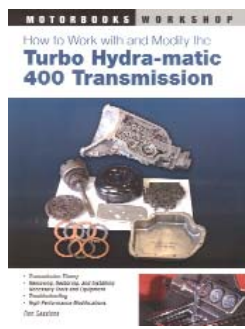

### Turbo Hydra-Matic 400 Transmission book

How to remove, rebuild, restore, install and troubleshoot your GM TH400 transmission. 224 pages.

67-19107 TH400 ..... \$ 25.00 ea.

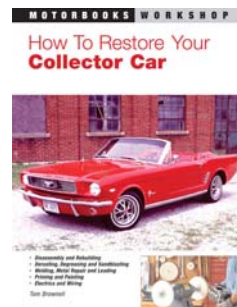

### How To Restore Your Collector Car

This book covers disassembly, de-rusting, degreasing, sandblasting, welding, metal repair, leading, fillers, electronics, rebuilding, wiring, upholstery, convertibles, priming, research painting, plating buffing, preservation, sources, and much more! 286 pages.

67-19109 All cars ..... \$ 29.00 ea.

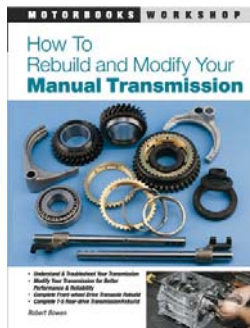

### How To Rebuild & Modify Your Manual Transmission

67-19112 192 pages ..... \$ 26.00 ea.

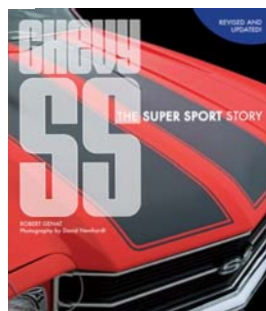

### Chevy SS The Super Sport Story

Chevy SS: The Super Sport Story provides a close-up, detailed, full-color look at such classic muscle cars as the Chevelle, El Camino, Malibu, and Monte Carlo.

67-19120 348 pages ..... \$ 33.00 ea.

## BOOKS & LITERATURE

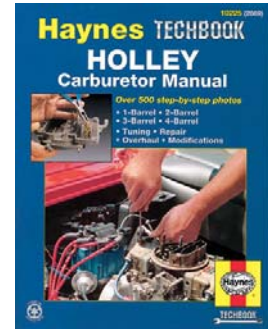

### Holley Carburetor Manual

Over 500 step by step photos, Tuning, repair, overhaul & modifications.

67-19114 253 pages ..... \$ 24.00 ea.

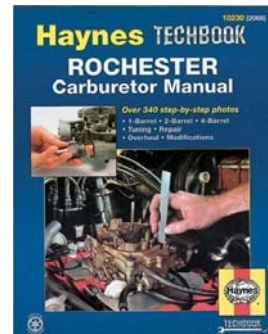

### Rochester Carburetor Manual

67-19115 179 pages ..... \$ 19.00 ea.

## MUSCLE

AMERICA'S LEGENDARY PERFORMANCE CARS



RANDY LEFFINGWELL & DARWIN HOLMSTROM  
PHOTOGRAPHY BY DAVID NEWHARDT, FOREWORD BY JIM WALKERS

### Muscle - America's Legendary Performance Cars

Muscle: Americas Legendary Performance Cars brings to life the history of American muscle, from the street-racing hot rod culture that emerged after World War II through the new breed of muscle cars.

67-193081 384 pages ..... \$ 40.00 ea.

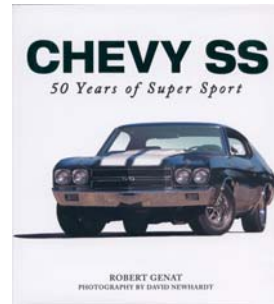

### Chevy SS - 50 Years of Super Sport

At the dawn of the muscle car era Chevrolet introduced the Super Sport version of its popular Impala, the first in a long line of legendary SS models. Chevelle, Camaro, El Camino, Malibu & Monte Carlo.

67-193082 352 pages ..... \$ 45.00 ea.

+ The following items require additional shipping and handling.

Fax Order 1-714-771-0407 • Toll Free 1-800-235-2470 • [www.TruckandCarShop.com](http://www.TruckandCarShop.com) • 2014 Catalog



# CHEVROLET NOVA PARTS

Car Shop Inc. 739 North Batavia Orange, California 92868

## BOOKS & LITERATURE

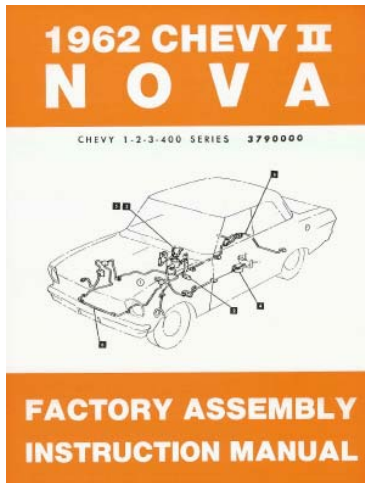

### Assembly Manuals

This book is a must for any restoration project. Copy of the original assembly line manuals used to assemble the car. Shows exploded views of everything from A-arms to wiring harnesses. 200-400 pages.

|          |    |       |              |
|----------|----|-------|--------------|
| 62-19401 | 62 | ..... | \$ 20.00 ea. |
| 63-19401 | 63 | ..... | \$ 20.00 ea. |
| 64-19401 | 64 | ..... | \$ 20.00 ea. |
| 65-19401 | 65 | ..... | \$ 20.00 ea. |
| 66-19401 | 66 | ..... | \$ 20.00 ea. |
| 67-19402 | 67 | ..... | \$ 20.00 ea. |
| 68-19401 | 68 | ..... | \$ 20.00 ea. |
| 69-19401 | 69 | ..... | \$ 20.00 ea. |
| 70-19401 | 70 | ..... | \$ 20.00 ea. |
| 71-19401 | 71 | ..... | \$ 20.00 ea. |
| 72-19401 | 72 | ..... | \$ 20.00 ea. |

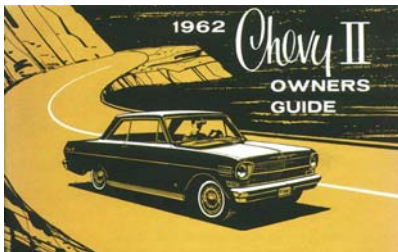

### Owners Manuals

Beautiful full color reprints of the factory glove box owners manuals.

|          |    |       |              |
|----------|----|-------|--------------|
| 62-19408 | 62 | ..... | \$ 10.00 ea. |
| 63-19408 | 63 | ..... | \$ 10.00 ea. |
| 64-19408 | 64 | ..... | \$ 10.00 ea. |
| 65-19408 | 65 | ..... | \$ 10.00 ea. |
| 66-19408 | 66 | ..... | \$ 10.00 ea. |
| 67-19408 | 67 | ..... | \$ 10.00 ea. |
| 68-19408 | 68 | ..... | \$ 10.00 ea. |
| 69-19409 | 69 | ..... | \$ 10.00 ea. |
| 70-19409 | 70 | ..... | \$ 10.00 ea. |
| 71-19409 | 71 | ..... | \$ 10.00 ea. |
| 72-19409 | 72 | ..... | \$ 10.00 ea. |
| 73-19409 | 73 | ..... | \$ 10.00 ea. |
| 74-19409 | 74 | ..... | \$ 10.00 ea. |

## BOOKS & LITERATURE



### Owners Manual Storage Bag

|          |    |                |             |
|----------|----|----------------|-------------|
| 58-11942 | 62 | envelope ..... | \$ 3.50 ea. |
|----------|----|----------------|-------------|



|          |       |                   |             |
|----------|-------|-------------------|-------------|
| 63-11943 | 63-66 | Storage bag ..... | \$ 4.00 ea. |
| 67-19413 | 67-68 | Storage bag ..... | \$ 4.00 ea. |
| 69-19414 | 69-72 | Storage bag ..... | \$ 4.00 ea. |

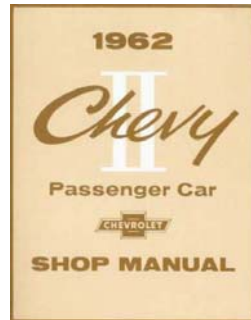

### Chassis Shop/Service Manuals

These huge books cover all topics of auto repair. Lots of pictures with step by step instructions. Same book the Chevy dealers use for repairs. Covers routine maintenance and adjustments. Also covers brakes, fuel system, wiring and much more.

|          |    |                                       |              |
|----------|----|---------------------------------------|--------------|
| 62-19415 | 62 | Shop Manual .....                     | \$ 24.00 ea. |
| 63-19415 | 63 | supplement to 1962 . . .              | \$ 16.00 ea. |
| 64-19415 | 64 | supplement to 1962 . . .              | \$ 16.00 ea. |
| 65-11921 | 65 | Chassis Service Manual .              | \$ 20.00 ea. |
| 65-11922 | 65 | Chassis Overhaul Service Manual ..... | \$ 24.00 ea. |
| 66-11924 | 66 | .....                                 | \$ 24.00 ea. |
| 67-19415 | 67 | .....                                 | \$ 24.00 ea. |



|          |    |       |              |
|----------|----|-------|--------------|
| 68-19416 | 68 | ..... | \$ 24.00 ea. |
| 69-19417 | 69 | ..... | \$ 24.00 ea. |
| 70-19418 | 70 | ..... | \$ 16.00 ea. |
| 71-19419 | 71 | ..... | \$ 24.00 ea. |
| 72-19420 | 72 | ..... | \$ 24.00 ea. |
| 73-19420 | 73 | ..... | \$ 40.00 ea. |
| 74-19420 | 74 | ..... | \$ 40.00 ea. |

## BOOKS & LITERATURE

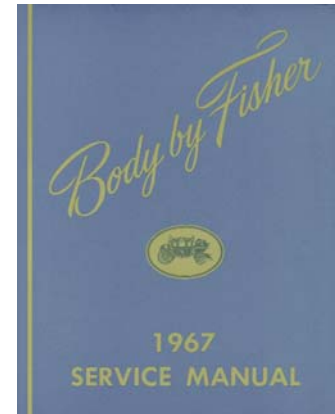

### Fisher Body Manuals

This useful manual covers installation procedures for body related parts; molding, trim, glass, door panels, seats etc... Fully illustrated, over 400 pages.

(AKA: Body service manual)

|          |    |       |              |
|----------|----|-------|--------------|
| 65-11934 | 65 | ..... | \$ 24.00 ea. |
| 66-11935 | 66 | ..... | \$ 24.00 ea. |
| 67-19421 | 67 | ..... | \$ 24.00 ea. |
| 68-19422 | 68 | ..... | \$ 24.00 ea. |
| 69-19423 | 69 | ..... | \$ 24.00 ea. |
| 70-19424 | 70 | ..... | \$ 24.00 ea. |
| 71-19425 | 71 | ..... | \$ 24.00 ea. |
| 72-19426 | 72 | ..... | \$ 24.00 ea. |

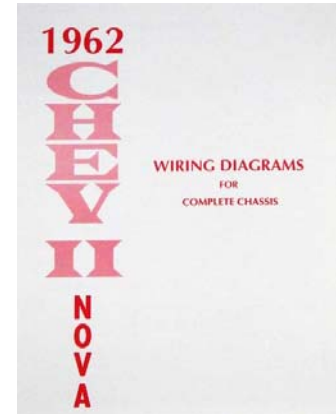

### Wiring Diagrams

Make your wiring project easier with one of our wiring manuals. Covers the dash harness, engine harness and lamp harnesses. This is the schematic only!

|          |    |       |             |
|----------|----|-------|-------------|
| 62-19427 | 62 | ..... | \$ 6.00 ea. |
| 63-19427 | 63 | ..... | \$ 6.00 ea. |
| 64-19427 | 64 | ..... | \$ 6.00 ea. |
| 65-19427 | 65 | ..... | \$ 6.00 ea. |
| 66-19427 | 66 | ..... | \$ 6.00 ea. |
| 67-19428 | 67 | ..... | \$ 6.00 ea. |
| 68-19427 | 68 | ..... | \$ 6.00 ea. |
| 69-19427 | 69 | ..... | \$ 6.00 ea. |
| 70-19427 | 70 | ..... | \$ 6.00 ea. |
| 71-19427 | 71 | ..... | \$ 6.00 ea. |
| 72-19427 | 72 | ..... | \$ 6.00 ea. |
| 73-19427 | 73 | ..... | \$ 6.00 ea. |
| 74-19427 | 74 | ..... | \$ 6.00 ea. |

✦ The following items require additional shipping and handling.

# CHEVROLET NOVA PARTS



Car Shop Inc. 739 North Batavia Orange, California 92868

## BOOKS & LITERATURE

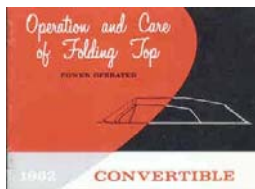

### Convertible Top Operation Manual

|          |    |       |             |
|----------|----|-------|-------------|
| 62-12030 | 62 | ..... | \$ 7.00 ea. |
| 63-12031 | 63 | ..... | \$ 7.00 ea. |



### Accessory Brochure

|          |    |       |              |
|----------|----|-------|--------------|
| 62-19503 | 62 | ..... | \$ 9.00 ea.  |
| 63-11735 | 63 | ..... | \$ 10.00 ea. |
| 64-11736 | 64 | ..... | \$ 10.00 ea. |



|          |    |       |              |
|----------|----|-------|--------------|
| 65-11737 | 65 | ..... | \$ 10.00 ea. |
| 66-19503 | 66 | ..... | \$ 10.00 ea. |
| 67-19503 | 67 | ..... | \$ 10.00 ea. |
| 68-19503 | 68 | ..... | \$ 10.00 ea. |
| 69-19505 | 69 | ..... | \$ 10.00 ea. |
| 70-11738 | 70 | ..... | \$ 15.00 ea. |
| 71-11738 | 71 | ..... | \$ 8.00 ea.  |



### FACTS & FEATURE MANUAL

### Illustrated Fact/Features Manual

|          |    |       |             |
|----------|----|-------|-------------|
| 64-19440 | 64 | ..... | \$ 8.00 ea. |
| 66-19440 | 66 | ..... | \$ 8.00 ea. |
| 67-19440 | 67 | ..... | \$ 8.00 ea. |
| 68-19440 | 68 | ..... | \$ 8.00 ea. |
| 69-19440 | 69 | ..... | \$ 8.00 ea. |

### Yenco Sales Specification Sheet

|          |    |             |       |             |
|----------|----|-------------|-------|-------------|
| 70-19440 | 70 | Yenco Deuce | ..... | \$ 7.00 ea. |
|----------|----|-------------|-------|-------------|

## BOOKS & LITERATURE



### Sales Brochure

Reproduction of the original Chevrolet sales brochure that was handed out at the dealership.

|          |    |       |              |
|----------|----|-------|--------------|
| 62-19506 | 62 | ..... | \$ 10.00 ea. |
| 63-19506 | 63 | ..... | \$ 10.00 ea. |
| 64-19506 | 64 | ..... | \$ 10.00 ea. |
| 65-19506 | 65 | ..... | \$ 10.00 ea. |
| 66-19506 | 66 | ..... | \$ 10.00 ea. |
| 67-19507 | 67 | ..... | \$ 10.00 ea. |
| 68-19506 | 68 | ..... | \$ 10.00 ea. |
| 69-19506 | 69 | ..... | \$ 10.00 ea. |
| 70-19506 | 70 | ..... | \$ 10.00 ea. |
| 71-19506 | 71 | ..... | \$ 10.00 ea. |
| 72-19506 | 72 | ..... | \$ 10.00 ea. |
| 73-19506 | 73 | ..... | \$ 10.00 ea. |
| 74-19506 | 74 | ..... | \$ 10.00 ea. |

## ICE CHEST



5-gallon capacity, built-in bottle opener with removable snack tray. Made from rust-resistant zinc steel with powder coated finish. Measures 18" x 8 3/4" x 12" tall, with locking handle.

|          |                          |       |              |
|----------|--------------------------|-------|--------------|
| 67-19651 | Blue with white details  | ..... | \$ 79.00 ea. |
| 67-19652 | Red with white details   | ..... | \$ 79.00 ea. |
| 67-19653 | Black with white details | ..... | \$ 79.00 ea. |

## CAR COVERS

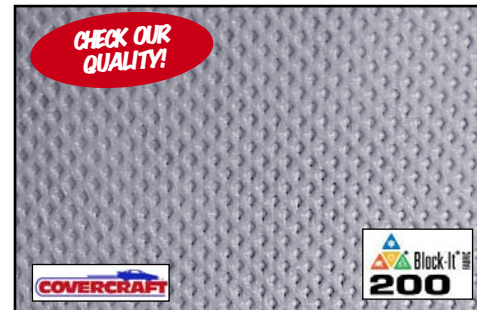

### 200 Series / Multibond® Fabric, gray.

200 Series uses 3-layer polypropylene construction for moisture and dust resistance, and the fibers are treated for extra UV resistance. If you are looking for an inexpensive cover for indoor storage and limited outdoor use, this U.S. made fabric offers good, basic protection and is an excellent value.

2 Year Limited Warranty - Against defects in workmanship and/or the fabric becoming unserviceable during normal use. Covercraft will repair or replace, to the original purchaser, after required inspection.

|           |       |             |                     |
|-----------|-------|-------------|---------------------|
| 62-195091 | 62-65 | all         |                     |
|           | 66-67 | 4 door      | ..... \$ 139.00 ea. |
| 66-195091 | 66-67 | 2 door      | ..... \$ 139.00 ea. |
| 68-195091 | 68-79 | 2 or 4 door | ..... \$ 139.00 ea. |



### 380 Series DELUXE Fabric, taupe.

The three-layer construction uses inner and outer layers of spunbond, sandwiching a middle layer protective film barrier. The film barrier has microscopic holes, smaller than droplets of water and most dust particles to stop moisture, but still allow any moisture vapor or heat to easily escape from under the cover.

Won't shrink or stretch and retains its tailored shape.

3 Year Limited Warranty - Against defects in workmanship and/or the fabric becoming unserviceable during normal use. Covercraft will repair or replace, to the original purchaser, after required inspection.

|           |       |             |                     |
|-----------|-------|-------------|---------------------|
| 62-195121 | 62-65 | all         |                     |
|           | 66-67 | 4 door      | ..... \$ 179.00 ea. |
| 66-195121 | 66-67 | 2 door      | ..... \$ 179.00 ea. |
| 68-195121 | 68-79 | 2 or 4 door | ..... \$ 179.00 ea. |



This heavy cotton blend cover will fit your car perfectly. Features a flannel underside for added paint protection.

|          |       |             |                     |
|----------|-------|-------------|---------------------|
| 68-19514 | 68-79 | 2 or 4 door | ..... \$ 239.00 ea. |
|----------|-------|-------------|---------------------|

\* The following items require additional shipping and handling.

Fax Order 1-714-771-0407 • Toll Free 1-800-235-2470 • [www.TruckandCarShop.com](http://www.TruckandCarShop.com) • 2014 Catalog



# CHEVROLET NOVA PARTS

Car Shop Inc. 739 North Batavia Orange, California 92868

## FUZZY DICE



|          |       |         |      |     |
|----------|-------|---------|------|-----|
| 67-19518 | Black | .....\$ | 5.00 | pr. |
| 67-19519 | Blue  | .....\$ | 5.00 | pr. |
| 67-19520 | Red   | .....\$ | 5.00 | pr. |
| 67-19521 | White | .....\$ | 5.00 | pr. |

## FUZZY 8-BALLS



|          |       |         |      |     |
|----------|-------|---------|------|-----|
| 67-19523 | Black | .....\$ | 6.00 | pr. |
|----------|-------|---------|------|-----|

## CAR & DASH DUSTERS



|           |     |         |       |     |
|-----------|-----|---------|-------|-----|
| 67-197162 | Car | .....\$ | 15.00 | ea. |
|-----------|-----|---------|-------|-----|



|           |      |         |       |     |
|-----------|------|---------|-------|-----|
| 67-197163 | Dash | .....\$ | 10.00 | ea. |
|-----------|------|---------|-------|-----|

## SKULL SHIFT KNOBS



|          |        |         |      |     |
|----------|--------|---------|------|-----|
| 67-19536 | Chrome | .....\$ | 9.00 | ea. |
|----------|--------|---------|------|-----|

## KEY CHAINS



|          |             |         |      |     |
|----------|-------------|---------|------|-----|
| 67-19610 | Dice, clear | .....\$ | 5.00 | ea. |
|----------|-------------|---------|------|-----|



|                                 |       |         |      |     |
|---------------------------------|-------|---------|------|-----|
| <i>Polished Stainless Steel</i> |       |         |      |     |
| 67-19613                        | Girl  | .....\$ | 9.00 | ea. |
| 67-19614                        | Felix | .....\$ | 9.00 | ea. |

## CHROME KEY CHAINS



|           |    |           |         |       |     |
|-----------|----|-----------|---------|-------|-----|
| 67-196151 | 67 | Camaro    | .....\$ | 16.00 | ea. |
| 67-196152 | 67 | Camaro SS | .....\$ | 16.00 | ea. |
| 67-196153 | 67 | Chevrolet | .....\$ | 15.00 | ea. |



|           |                |         |      |     |
|-----------|----------------|---------|------|-----|
| 67-196155 | Bow-Tie piston | .....\$ | 7.00 | ea. |
|-----------|----------------|---------|------|-----|

## YEAR KEY CHAINS



|                                 |    |         |      |     |
|---------------------------------|----|---------|------|-----|
| <i>Polished stainless steel</i> |    |         |      |     |
| 49-19616                        | 49 | .....\$ | 9.00 | ea. |
| 50-19616                        | 50 | .....\$ | 9.00 | ea. |
| 51-19616                        | 51 | .....\$ | 9.00 | ea. |
| 52-19616                        | 52 | .....\$ | 9.00 | ea. |
| 53-19616                        | 53 | .....\$ | 9.00 | ea. |
| 54-19616                        | 54 | .....\$ | 9.00 | ea. |
| 55-19616                        | 55 | .....\$ | 9.00 | ea. |
| 56-19616                        | 56 | .....\$ | 9.00 | ea. |
| 57-19616                        | 57 | .....\$ | 9.00 | ea. |



|                                 |    |         |      |     |
|---------------------------------|----|---------|------|-----|
| <i>Polished Stainless Steel</i> |    |         |      |     |
| 58-19616                        | 58 | .....\$ | 9.00 | ea. |
| 59-19616                        | 59 | .....\$ | 9.00 | ea. |
| 60-19616                        | 60 | .....\$ | 9.00 | ea. |
| 61-19616                        | 61 | .....\$ | 9.00 | ea. |
| 62-19616                        | 62 | .....\$ | 9.00 | ea. |
| 63-19616                        | 63 | .....\$ | 9.00 | ea. |
| 64-19616                        | 64 | .....\$ | 9.00 | ea. |
| 65-19616                        | 65 | .....\$ | 9.00 | ea. |
| 66-19616                        | 66 | .....\$ | 9.00 | ea. |
| 67-19616                        | 67 | .....\$ | 9.00 | ea. |
| 67-19617                        | 68 | .....\$ | 9.00 | ea. |
| 67-19618                        | 69 | .....\$ | 9.00 | ea. |
| 67-19619                        | 70 | .....\$ | 9.00 | ea. |
| 67-19620                        | 71 | .....\$ | 9.00 | ea. |
| 67-19621                        | 72 | .....\$ | 9.00 | ea. |



### Showroom hours:

**TUESDAY - FRIDAY: 8:30AM to 4:30PM**  
**SATURDAY: 8:30AM to 3:30PM**

### Phone order desk hours:

**MONDAY - FRIDAY: 8:30AM to 4:30PM**  
[www.TruckandCarShop.com](http://www.TruckandCarShop.com)

+ The following items require additional shipping and handling.



# CHEVROLET NOVA PARTS



Car Shop Inc. 739 North Batavia Orange, California 92868

## HATS



### CAR SHOP LOGO HAT

All Hats are Embroidered

62-19707 black .....\$ 12.00 ea.



### NOVA BY CHEVROLET

62-119081 "Nova by Chevrolet",  
Black - Black bill .....\$ 14.00 ea.  
62-119082 "Nova by Chevrolet",  
Tan - Black bill .....\$ 14.00 ea.  
62-119083 "Nova by Chevrolet",  
Blue - Black bill .....\$ 14.00 ea.



### "BOW TIE" WITH FLAMES

67-19707 black-gray .....\$ 14.00 ea.  
67-19708 black-red .....\$ 14.00 ea.  
67-19709 black-blue .....\$ 14.00 ea.



### "GENUINE CHEVROLET PARTS"

67-197091 black .....\$ 19.00 ea.



67-197092 tan .....\$ 19.00 ea.

## T-SHIRTS



### GM Accessories Logo T-shirt.

60-19710 L, Tan .....\$ 15.00 ea.  
60-19711 XL, Tan .....\$ 15.00 ea.  
60-19712 XXL, Tan .....\$ 17.00 ea.  
60-19713 XXXL, Tan .....\$ 17.00 ea.



### Car Shop T-shirt

(back as shown; front has small Car Shop logo above left pocket)

67-19710 L, white .....\$ 15.00 ea.  
67-19711 XL, white .....\$ 15.00 ea.  
67-19712 XXL, white .....\$ 17.00 ea.



### Lil' Deuces / Nova (back as shown)

62-19710 L, white .....\$ 15.00 ea.  
62-19711 XL, white .....\$ 15.00 ea.  
62-19712 XXL, white .....\$ 17.00 ea.

## T-SHIRTS



### Camaro SS (back as shown)

67-19713 L, white .....\$ 15.00 ea.  
67-19714 XL, white .....\$ 15.00 ea.  
67-19715 XXL, white .....\$ 17.00 ea.



### Chevelle SS (back as shown)

64-19710 L, white .....\$ 15.00 ea.  
64-19711 XL, white .....\$ 15.00 ea.  
64-19712 XXL, white .....\$ 17.00 ea.



### Impala SS Logo#2 (back as shown)

63-19713 L, white .....\$ 15.00 ea.  
63-19714 XL, white .....\$ 15.00 ea.  
63-19715 XXL, white .....\$ 17.00 ea.

\* The following items require additional shipping and handling.

Fax Order 1-714-771-0407 • Toll Free 1-800-235-2470 • [www.TruckandCarShop.com](http://www.TruckandCarShop.com) • 2014 Catalog



# CHEVROLET NOVA PARTS

Car Shop Inc. 739 North Batavia Orange, California 92868

## DECALS

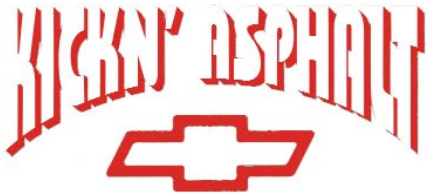

- 67-19716 Kickn' Asphalt, 3" .....\$ 4.00 ea.
- 67-19717 Kickn' Asphalt, 6" .....\$ 6.00 ea.



- 67-19718 Heartbeat of America, 3" ....\$ 4.00 ea.
- 67-19719 Heartbeat of America, 6" ....\$ 5.00 ea.
- 67-197191 Heartbeat of America, 12"x7" \$ 8.00 ea.
- 67-19720 Heartbeat of America Yesterday's Chevrolet, 7" ....\$ 5.00 ea.



- 67-197201 Bow Tie, black, 16.5" .....\$ 8.00 ea.
- 67-197202 Bow Tie, blue, 16.5" .....\$ 8.00 ea.
- 67-197203 Bow Tie, red, 16.5" .....\$ 8.00 ea.
- 67-197204 Bow Tie, white, 16.5" .....\$ 8.00 ea.



- 67-19721 Bow Tie, red, 8" .....\$ 6.00 ea.
- 67-19722 Bow Tie, blue, 8" .....\$ 6.00 ea.
- 67-19723 Bow Tie, black, 8" .....\$ 6.00 ea.
- 67-19724 Bow Tie, gold, 8" .....\$ 6.00 ea.
- 67-19725 Bow Tie, white, 8" .....\$ 6.00 ea.



- 67-19727 Bow Tie, blue, 3" .....\$ 4.00 ea.
- 67-19728 Bow Tie, black, 3" .....\$ 4.00 ea.
- 67-19729 Bow Tie, white, 3" .....\$ 4.00 ea.

## DECALS



- 67-197291 White "Chevrolet" with red bow tie, 24" .....\$ 10.00 ea.
- 67-197292 Black "Chevrolet" with red bow tie, 24" .....\$ 10.00 ea.
- 67-197293 White "Chevrolet" with red bow tie, 16" .....\$ 9.00 ea.



- Chevy Thunder.
- 67-19730 Black/Purple, 10" .....\$ 9.00 ea.
  - 67-19731 White/White, 10" .....\$ 9.00 ea.
  - 67-19732 Red/Black, 10" .....\$ 9.00 ea.
  - 67-19733 Red/White, 10" .....\$ 9.00 ea.



- 67-19801 "Chevrolet" in Bow Tie, 7", Blue .....\$ 7.00 ea.



- 67-198011 "Chevrolet" in Bow Tie, 13.5", Blue .....\$ 9.00 ea.



- 67-19805 "Bow Tie", 36", red .....\$ 16.00 ea.
- 67-19806 "Bow Tie", 36", white .....\$ 16.00 ea.



- 67-19808 "Heartbeat", 36", red .....\$ 16.00 ea.
- 67-19809 "Heartbeat", 36", white .....\$ 16.00 ea.
- 67-19810 "Heartbeat", 36", blue .....\$ 16.00 ea.
- 67-19811 "Heartbeat", 36", black .....\$ 16.00 ea.

## CHEVROLET LOGO DECALS



- Chevrolet Super Service
- 67-19802 5-1/2" round .....\$ 5.00 ea.
  - 67-198021 12" round .....\$ 7.00 ea.



- We Use Genuine Chevrolet Parts
- 67-19803 5-1/2" round .....\$ 5.00 ea.



- OK Used Cars
- 67-19804 5-1/2" round .....\$ 5.00 ea.
  - 67-198041 12" round .....\$ 7.00 ea.

## CHEVROLET RACING DECALS



- 67-19814 "Chevrolet Racing", 4" .....\$ 4.00 ea.
- 67-19815 "Chevrolet Racing", 6" .....\$ 6.00 ea.

# CHEVROLET NOVA PARTS



Car Shop Inc. 739 North Batavia Orange, California 92868



† The following items require additional shipping and handling.

Fax Order 1-714-771-0407 • Toll Free 1-800-235-2470 • [www.TruckandCarShop.com](http://www.TruckandCarShop.com) • 2014 Catalog



# Parts are Parts? Right?

Truck Shop and Car Shop offer  
the highest quality parts at the best prices!  
Here is a good example of our quality vs. the other guys.

## *Car Shop part*

## *the competitors part*

*Is this the first thing you want to see under your hood?*



Truck & Car Shop offers this Fan shroud.

*or is this the first thing you want to see under your hood?*



Our competitors offer this Fan shroud.

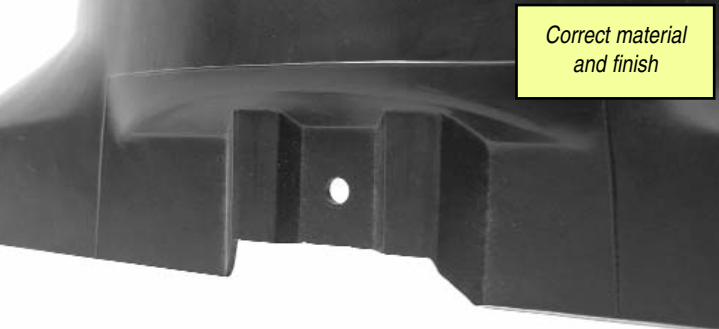

Correct material and finish

• Truck & Car Shop • correct molded top



What kind of finish is this?  
Whale skin finish? maybe.

• competitors, how do you mount this? •



• Truck & Car Shop • correct ridged material



• ? •



OUR CATALOG STATES  
 • **CAR SHOP** •  
 • **TRUCK SHOP** •  
 • **BEST QUALITY** •  
 • **BEST PRICE** •  
 BELIEVE IT!



The Manufacturer of this part states:  
 1: our products are the standard to which all other restoration parts are measured.  
 2: each part is manufactured to original specifications, down to the smallest detail.  
 3: the finished product meets or exceeds original equipment specs.  
 4: Our consistent quality control methods ensure an exact duplicate every time.  
Time to fire the Quality Control guys

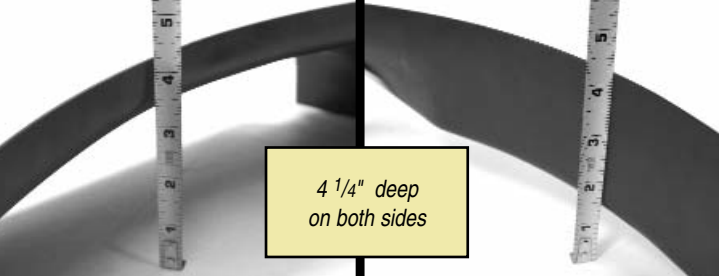

4 1/4" deep on both sides

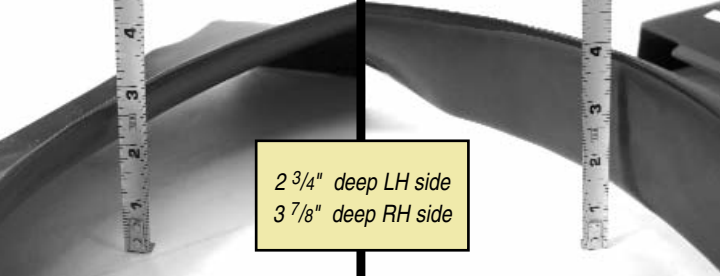

2 3/4" deep LH side  
3 7/8" deep RH side

Car Shop price \$ 75.00

competitors price \$ 79.99



# TRUCK AND CAR SHOP



# INFORMATION



## Car Shop offers parts catalogs for:

- 1947-1959 Chevrolet / GMC Trucks
- 1960-1972 Chevrolet / GMC Trucks
- 1973-1991 Chevrolet / GMC Trucks
- 1941-1957 Full Size Chevrolet Cars
- 1958-1972 Full Size Chevrolet Cars
- 1964-1987 Chevelle / El Camino
- 1967-1981 Camaro
- 1962-1974 Chevy II / Nova
- 1948-1986 Ford Trucks
- 1966-1986 Ford Bronco
- 1964-1973 Ford Mustang

### Car Shop 2nd Location in Concord North Carolina.

2701 Derita Road Concord NC 28027  
704-979-6490 Fax: 704-979-5157

**NEW**  
2nd Location  
CONCORD NC



## PROPOSED SWAP MEET SCHEDULE FOR 2014:

- ♥ Pomona, CA. .... January 19
- ♥ Turlock, CA. .... January 25-26
- ♥ Moultrie, GA. .... Jan 31- Feb 1
- ♥ Pomona, CA. .... March 2
- ♥ Charlotte, NC. .... April 3-5
- ♥ Portland, OR. .... April 4-5
- ♥ Pomona, CA. .... April 13
- ♥ Carlisle, PA. "Spring" .... April 24-26
- ♥ Fort Worth, TX. "Pate" .... April 24-26
- ♥ Pomona, CA. .... June 1
- ♥ Carlisle, PA. (Truck Nationals) .... August 1-2
- ♥ Pomona, CA. .... August 10
- ♥ Pigeon Forge, TN. .... September 5-6
- ♥ Charlotte, NC. .... September 18-20
- ♥ Carlisle, PA. "Fall" .... October 2-4
- ♥ Pomona, CA. .... October 19
- ♥ Charlotte, NC. .... October 24-25
- ♥ Moultrie, GA. .... November 21-22
- ♥ Pomona, CA. .... December 7

Call or check web site for exact dates

• [www.TruckandCarShop.com](http://www.TruckandCarShop.com) •

### California Showroom hours:

**TUESDAY - FRIDAY: 8:30AM to 4:30PM**

**SATURDAY: 8:30AM to 3:30PM**

(Showroom closed Sunday & Monday)

### Phone order desk hours:

**MONDAY - FRIDAY: 8:30AM to 4:30PM**

**ORDER TOLL FREE: 1-800-235-2470**

**24 HOUR FAX: 714-771-0407**





# Truck Shop & Car Shop

We need to keep your account current.

THE FOLLOWING INFO WILL HELP US KEEP YOU INFORMED OF UP COMING SPECIALS, SALES, ETC.

NAME:

E-MAIL ADDRESS:

ADDRESS:

CITY / STATE / ZIP:

TELEPHONE:

MAKE / MODEL / YEAR:

This information is for **Truck Shop & Car Shop** use only!



## Shipping Charge Map

**zone 1** (OR, NV, UT, AZ)

**zone 2** (ID, WY, CO, MT, ND, SD, NE, WY, CO, KS)

**zone 3** (OH, PA, IN, NY, NJ, CT, RI, MA, VT, NH, ME)

**FREE SHIPPING!!**  
All orders over **\$350.00** receive FREE standard UPS ground shipping within the USA. (excludes Alaska and Hawaii).  
Truck freight items, oversize, overweight, additional handling, expedited and overnite shipments do not apply to free shipping incentive.

CALL FOR SHIPPING COSTS.

(+) next to part #, REQUIRE ADDITIONAL SHIPPING AND HANDLING CHARGES